



WF-C4810 Series User's Guide

Contents

WF-C4810 User's Guide	15
Product Basics	16
Using the Control Panel	16
Control Panel Buttons and Lights	17
The LCD Screen	18
Status Icon Information	19
Navigating the LCD Screen.....	20
Entering Characters on the LCD Screen	21
Viewing Animations	22
Selecting the Date and Time	22
Selecting Your Country or Region	23
Using Presets	24
Changing LCD Screen Language.....	26
Adjusting Control Panel Sounds	27
Adjusting the Screen Brightness.....	28
Turning Off the Operation Time Out Setting	29
Preventing PC Connection via USB	30
Product Parts Locations	31
Product Parts - Front	32
Product Parts - Inside	34
Product Parts - Back.....	36
Checking for Software Updates.....	36
Using Power Saving Settings	37
Changing the Sleep Timer Settings	37
Changing the Power Off Timer Settings	39
Epson Connect Solutions for Smartphones, Tablets, and More	40
Setting Up Epson Connect Services.....	40
Using Epson Email Print	42
Using the Epson Smart Panel Mobile App.....	42
Using the Epson iPrint Mobile App	43

Using Epson Remote Print	43
Using Epson Scan to Cloud	44
Using AirPrint	45
Setting Up Printing on a Chromebook	45
Android Printing Using the Epson Print Enabler	46
Using the Mopria Print Service	46
Using Fire OS Printing	47
Using Windows 10 Mobile Printing	47
Using Epson Print and Scan App with Windows Tablets	48
Voice-activated Printing	48
Wi-Fi or Wired Networking.....	50
Network Security Recommendations	50
Wi-Fi Infrastructure Mode Setup.....	51
Selecting Wireless Network Settings from the Control Panel	52
Setting Up Wireless Printing from a Smart Device Using Epson Smart Panel.....	54
Wi-Fi Direct Mode Setup	56
Enabling Wi-Fi Direct Mode (Simple AP).....	56
Enabling Wi-Fi Direct Mode.....	58
Modifying the Wi-Fi Direct Network Name or Password	60
Wi-Fi Protected Setup (WPS).....	62
Using WPS to Connect to a Network	62
Printing a Network Status Sheet.....	63
Printing a Network Connection Report	64
Network Connection Report Codes and Messages	66
Configuring Email Server Settings.....	71
Email Server Settings	73
Changing or Updating Network Connections	74
Accessing the Web Config Utility	74
Changing a USB Connection to a Wi-Fi Connection.....	75
Changing a Wi-Fi Connection to a Wired Network Connection.....	75
Connecting to a New Wi-Fi Router	76
Disabling Wi-Fi Features	76

Loading Paper	78
Loading Paper in the Cassette	78
Paper Loading Capacity	80
Double-sided Printing Capacity	84
Borderless Paper Type Compatibility	86
Compatible Epson Papers.....	87
Paper or Media Type Settings - Printing Software	89
Selecting the Paper Settings for Each Source - Control Panel	90
Paper Type Settings - Control Panel	91
Selecting the Default Paper Source Settings.....	92
Paper Source Settings Options	93
Selecting the Universal Print Settings	93
Universal Print Settings Options	94
Placing Originals on the Product	96
Placing Originals on the Scanner Glass	96
Placing Originals in the Automatic Document Feeder	98
ADF Original Document Specifications.....	101
Copying	103
Copying Documents or Photos.....	103
Copying Options.....	104
Printing from a Computer	108
Printing with Windows	108
Selecting Basic Print Settings - Windows	109
Paper Source Options - Windows	111
Print Quality Options - Windows	111
Multi-Page Printing Options - Windows.....	111
Selecting Double-sided Printing Settings - Windows	112
Double-sided Printing Options - Windows.....	114
Print Density Adjustments - Windows	115
Selecting Additional Layout and Print Options - Windows	116
Custom Color Correction Options - Windows.....	118
Image Options and Additional Settings - Windows.....	119
Header/Footer Settings - Windows	120

Selecting a Printing Preset - Windows	121
Selecting Extended Settings - Windows	122
Extended Settings - Windows	123
Printing Your Document - Windows	124
Locking Printer Settings - Windows	125
Locked Setting Options	127
Selecting Default Print Settings - Windows	128
Changing the Language of the Printer Software Screens	129
Changing Automatic Update Options	130
Printing with the Built-in Epson Driver - Windows 10 S	131
Selecting Print Settings - Windows 10 S	132
Printing on a Mac	135
Selecting Basic Print Settings - Mac	136
Paper Source Options - Mac	140
Print Quality Options - Mac	140
Print Options - Mac	141
Selecting Page Setup Settings - Mac	141
Selecting Print Layout Options - Mac	142
Selecting Double-sided Printing Settings - Mac	143
Double-sided Printing Options and Adjustments - Mac	144
Managing Color - Mac	145
Color Matching and Color Options - Mac	146
Selecting Printing Preferences - Mac	147
Printing Preferences - Mac	148
Printing Your Document or Photo - Mac	149
Checking Print Status - Mac	150
Printing from a Smartphone or Tablet	150
Cancelling Printing Using the Product	151
Scanning	152
Starting a Scan	152
Starting a Scan Using the Product Control Panel	152
Scanning to Email	154
Scanning to a Connected Computer	156

Setting Up a WSD Port (Windows 7/Windows Vista)	158
Scanning to the Cloud	159
Scanning to a Memory Device	161
Control Panel Scanning Options	162
Setting Up and Scanning to a Network Folder or FTP Server	165
Creating a Shared Network Folder	165
Registering Contacts for Email, Network, or FTP Scanning - Control Panel	167
Registering Contacts for Network Folder or FTP Scanning - Web Config	169
Scanning to a Network Folder or FTP Server	170
Starting a Scan Using the Epson Scan 2 Icon	172
Starting a Scan from a Scanning Program	174
Starting a Scan from a Smartphone or Tablet	176
Scanning a Document in Epson ScanSmart	176
Saving a Scan	179
Attaching a Scan to Email	180
Sending a Scan to a Cloud Service	181
Printing a Scan	182
Selecting Epson ScanSmart Settings	184
Changing the Epson Product	184
Changing the Scan Settings	185
Changing the File Name Settings	187
Changing the Save Settings	188
Save Settings	190
Customizing Action Icons	192
Scanning in Epson Scan 2	193
Additional Scanning Settings - Main Settings Tab	196
Additional Scanning Settings - Advanced Settings Tab	197
Saving Scanned Documents as a Searchable PDF Using Epson Scan 2	198
Image Format Options	199
Scan Resolution Guidelines	200
Faxing	202
Connecting a Telephone or Answering Machine	202
Setting Up Fax Features	205

Setting Up Basic Fax Features	205
Using the Fax Setup Wizard	205
Selecting the Line Type.....	207
Setting the Number of Rings to Answer	208
Selecting Advanced Fax Settings	209
Basic Settings - Fax	210
Send Settings - Fax.....	212
Receive Settings - Fax	213
Report Settings - Fax	214
Security Settings - Fax	215
Setting Up the Fax Utility - Windows.....	216
Setting Up Fax Features Using the Fax Utility - Mac	218
Setting Up Contacts and Contact Groups.....	219
Setting Up Contacts Using the Product Control Panel	220
Creating a Contact	220
Editing or Deleting a Contact	223
Creating a Contact Group	224
Editing or Deleting a Contact Group.....	226
Sending Faxes	228
Sending Faxes from the Product Control Panel.....	228
Sending a Fax Using the Keypad, Contact List, or History	228
Fax Sending Options	231
Sending a Fax at a Specified Time	232
Sending Faxes Using the Fax Utility - Windows	234
Sending Faxes Using the Fax Utility - Mac	236
Dialing Fax Numbers from a Connected Telephone	239
Receiving Faxes.....	240
Fax Reception	240
Receiving Faxes Automatically	241
Receiving Faxes Manually.....	241
Receiving a Fax by Polling	242
Viewing a Fax on the LCD Screen (Using the Inbox).....	243
Saving Faxes to an External USB Device	244

Checking Fax Status	245
Printing Fax Reports.....	246
Fax Report Options	247
Using External USB Devices with Your Product.....	249
Connecting a USB Device	249
USB Device Photo File Specifications	249
Disconnecting a USB Device.....	250
Viewing and Printing from the LCD Screen	250
Printing JPEG Photos.....	250
Printing TIFF Files	251
Print Setting Options - Device Mode.....	252
Transferring Files on a USB Device	254
Setting Up File Sharing for File Transfers from Your Computer.....	254
Transferring Files from a USB Device to Your Computer	255
Replacing Ink Cartridges and Maintenance Boxes.....	257
Ink Safety Precautions	257
Check Cartridge and Maintenance Box Status.....	259
Checking Cartridge and Maintenance Box Status on the LCD Screen	259
Checking Cartridge and Maintenance Box Status - Windows.....	260
Checking Cartridge and Maintenance Box Status - Mac	263
Purchase Epson Ink Cartridges and Maintenance Box	264
Ink Cartridge and Maintenance Box Part Numbers.....	264
Removing and Installing Ink Cartridges.....	265
Printing with Black Ink and Expended Color Cartridges	271
Printing with Expended Color Cartridges - Windows	271
Printing with Expended Color Cartridges - Mac	272
Conserving Low Black Ink with Windows	274
Replacing the Maintenance Box.....	274
Adjusting Print Quality.....	278
Print Head Maintenance.....	278
Print Head Nozzle Check.....	278
Checking the Nozzles Using the Product Control Panel	279
Checking the Nozzles Using a Computer Utility	281

Print Head Cleaning	282
Cleaning the Print Head Using the Product Control Panel	283
Cleaning the Print Head Using a Computer Utility	284
Aligning the Print Head Using the Product Control Panel	286
Adjusting the Print Quality Using the Product Control Panel	288
Cleaning the Paper Guide	289
Checking the Number of Sheets on the LCD Screen	290
Cleaning and Transporting Your Product	292
Cleaning Your Product	292
Transporting Your Product	296
Solving Problems	299
Viewing the Help Screen	299
Checking for Software Updates	300
Product Status Messages	301
Running a Product Check	305
Resetting Control Panel Defaults	306
Solving Setup Problems	307
Product Does Not Turn On or Off	308
Noise After Ink Installation	308
Software Installation Problems	308
Solving Network Problems	309
Product Cannot Connect to a Wireless Router or Access Point	309
Network Software Cannot Find Product on a Network	311
Product Does Not Appear in Mac Printer Window	311
Wireless Network Connection is Unstable on a Mac	312
Wired Network Connection Becomes Unstable	312
Cannot Print Over a Network	313
Cannot Scan Over a Network	314
Solving Copying Problems	315
Product Cannot Copy	316
Product Makes Noise, But Nothing Copies	316
Product Makes Noise When It Sits for a While	316
Originals Do Not Feed From the Automatic Document Feeder	317

Solving Paper Problems	318
Paper Feeding Problems	318
Paper Jam Problems in the Cassette	319
Paper Jam Problems in the Rear Cover	320
Document Jams in the Automatic Document Feeder	321
Paper Ejection Problems	324
Solving Problems Printing from a Computer	324
Nothing Prints	325
Product Icon Does Not Appear in Windows Taskbar	326
Error After Cartridge Replacement	327
Printing is Slow	327
Solving Page Layout and Content Problems	329
Inverted Image	329
Too Many Copies Print	330
Blank Pages Print	330
Incorrect Margins on Printout	330
Border Appears on Borderless Prints	331
Incorrect Characters Print	331
Incorrect Image Size or Position	332
Slanted Printout	333
Solving Print Quality Problems	333
White or Dark Lines in Printout	334
Blurry or Smearred Printout	335
Faint Printout or Printout Has Gaps	336
Grainy Printout	337
Incorrect Colors	338
Solving Scanning Problems	339
Scanning Software Does Not Operate Correctly	339
Cannot Start Epson Scan 2	340
Scanning Speed is Slow	341
Cannot Save a Scan to a Shared Folder Over a Network	341
Solving Scanned Image Quality Problems	343
Scanned Image Quality Problems	343

Image Consists of a Few Dots Only.....	345
Line of Dots Appears in All Scanned Images.....	345
Straight Lines in an Image Appear Crooked.....	346
Characters are Not Recognized During Conversion to Editable Text (OCR).....	346
Scanned Characters are Blurry.....	346
Image Colors are Patchy at the Edges.....	347
Ripple Patterns Appear in an Image.....	347
Streaks Appear in All Scanned Images.....	347
Scanned Image Edges are Cropped.....	348
Solving Faxing Problems.....	348
Cannot Send or Receive Faxes.....	348
Cannot Receive Faxes with a Telephone Connected to Your Product.....	350
Fax Memory Full Error Appears.....	351
Fax Quality is Poor.....	351
Sent Fax is Received in an Incorrect Size.....	352
Received Fax is Not Printed.....	353
Solving USB Device Problems.....	353
Cannot View or Print from a USB Device.....	353
Cannot Save Files on a USB Device.....	354
Cannot Transfer Files To or From a USB Device.....	354
Uninstall Your Product Software.....	355
Uninstalling Product Software - Windows.....	355
Uninstalling Product Software - Mac.....	356
Where to Get Help.....	357
Technical Specifications.....	359
Windows System Requirements.....	359
Mac System Requirements.....	360
Paper Specifications.....	360
Printable Area Specifications.....	362
Automatic Document Feeder (ADF) Specifications.....	363
Scanning Specifications.....	364
Fax Specifications.....	364
Ink Cartridge Specifications.....	365

Dimension Specifications	366
Electrical Specifications	367
Environmental Specifications	367
External USB Device Specifications.....	367
Interface Specifications	368
Network Interface Specifications	368
Safety and Approvals Specifications	370
Notices	372
Important Safety Instructions.....	372
General Product Safety Instructions	372
Ink Cartridge Safety Instructions.....	374
LCD Screen Safety Instructions.....	375
Wireless Connection Safety Instructions	376
Telephone Equipment Safety Instructions	376
Important Privacy Notice (Printer Serial Number).....	376
FCC Compliance Statement.....	377
Binding Arbitration and Class Waiver	379
Trademarks	382
Copyright Notice.....	383
libTIFF Software Acknowledgment.....	384
A Note Concerning Responsible Use of Copyrighted Materials.....	384
Default Delay Times for Power Management for Epson Products	384
Copyright Attribution	385

WF-C4810 User's Guide

Welcome to the WF-C4810 *User's Guide*.

For a printable PDF copy of this guide, [click here](#).

Product Basics

See these sections to learn about the basic features of your product.

Note: Your product may differ from the illustrations in this guide, but the instructions are the same.

[Using the Control Panel](#)

[Product Parts Locations](#)

[Checking for Software Updates](#)

[Using Power Saving Settings](#)

[Epson Connect Solutions for Smartphones, Tablets, and More](#)

[Using AirPrint](#)

[Setting Up Printing on a Chromebook](#)

[Android Printing Using the Epson Print Enabler](#)

[Using the Mopria Print Service](#)

[Using Fire OS Printing](#)

[Using Windows 10 Mobile Printing](#)

[Using Epson Print and Scan App with Windows Tablets](#)

[Voice-activated Printing](#)

Using the Control Panel

See these sections to learn about the control panel and select control panel settings.

[Control Panel Buttons and Lights](#)

[Entering Characters on the LCD Screen](#)

[Viewing Animations](#)

[Selecting the Date and Time](#)

[Selecting Your Country or Region](#)

[Using Presets](#)

[Changing LCD Screen Language](#)

[Adjusting Control Panel Sounds](#)

[Adjusting the Screen Brightness](#)

[Turning Off the Operation Time Out Setting](#)

[Preventing PC Connection via USB](#)

Parent topic: [Product Basics](#)

Control Panel Buttons and Lights

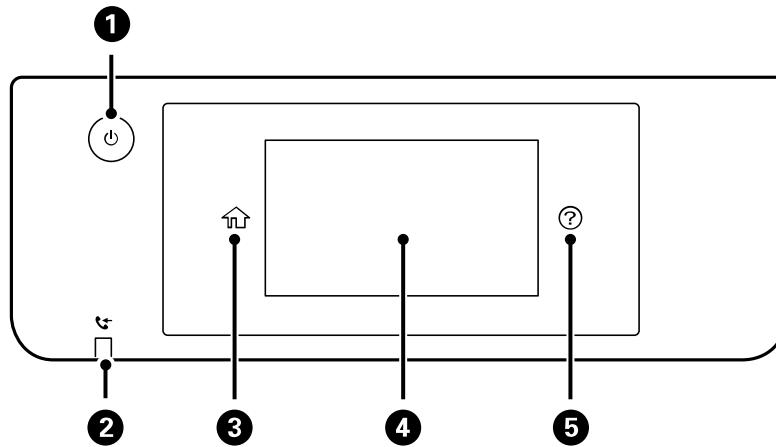

- 1 ⏻ power button and light
- 2 📠 received fax light
- 3 🏠 home button
- 4 LCD screen
- 5 ⓘ help button

[The LCD Screen](#)

[Status Icon Information](#)

[Navigating the LCD Screen](#)

Parent topic: [Using the Control Panel](#)

The LCD Screen

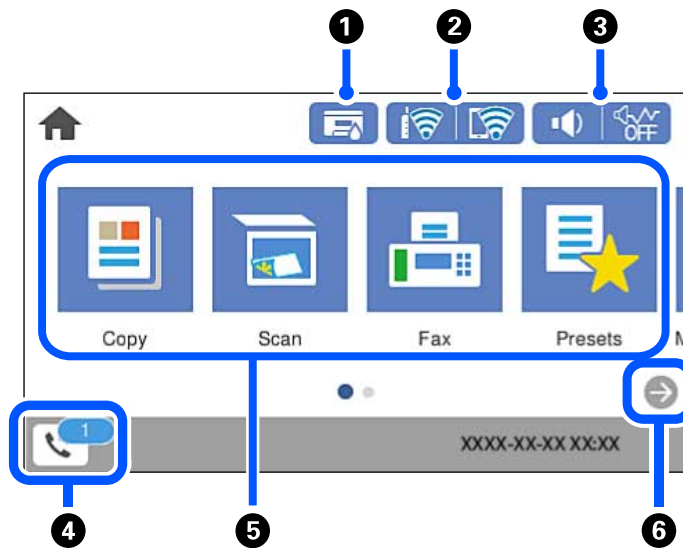

- 1 Select to show the Supply Status screen
- 2 Displays the network connection status. Select to set up network connections.
- 3 Select to change sound settings
- 4 Select to display the Fax Data Information screen
- 5 Displays various settings and functions. Swipe to the left to see additional options.

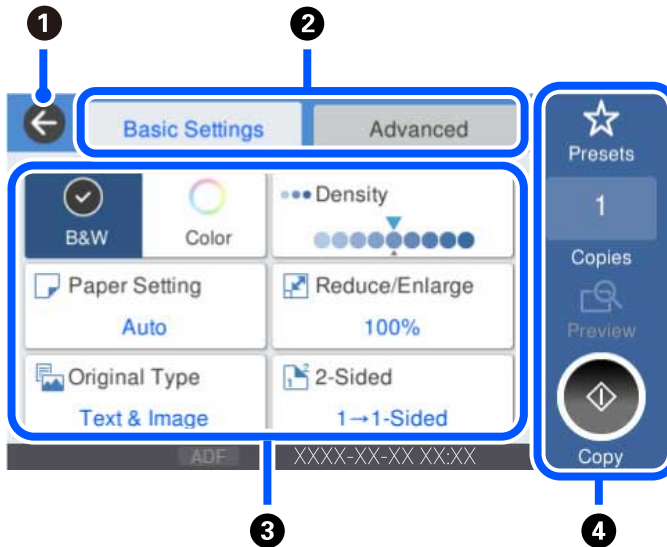

6 Scrolls the screen to the right.

















- 1 Returns to the previous screen
- 2 Select a tab to display additional settings
- 3 Displays the list of settings
- 4 Performs the selected action

Parent topic: [Control Panel Buttons and Lights](#)

Status Icon Information

Your product displays status icons on the LCD screen for certain product status conditions. Press the   icon to view or change the current network settings.



Icons	Description
	Displays additional information or instructions, such as loading paper or placing a document.
	Displays the Supply Status screen.



Icons	Description
	Quiet Mode is enabled. Noise is reduced during printing, but the print speed may be reduced. Press this icon to change the settings.
	Quiet Mode is disabled. Press this icon to change the settings.
	Displays the Fax Data Information screen.
	The indicated setting has changed.
	There is a problem with the indicated setting. Press the icon to resolve the problem.
	No Ethernet connection.
	An Ethernet connection is established.
	No Wi-Fi connection.
	A Wi-Fi network error has occurred or the product is searching for a connection.
	A Wi-Fi connection is established. The number of bars indicates the connection's signal strength.
	No Wi-Fi Direct connection.
	A Wi-Fi Direct connection is established.

Parent topic: [Control Panel Buttons and Lights](#)

Navigating the LCD Screen

Follow these guidelines to navigate and use the menus on the LCD screen.

-  Tap or press the screen to select an item or icon
-  Flick the screen to scroll swiftly
-  Slide your finger across the screen to move items



 Close or open your fingers across the screen to zoom in or zoom out on a preview image

Parent topic: [Control Panel Buttons and Lights](#)

Entering Characters on the LCD Screen

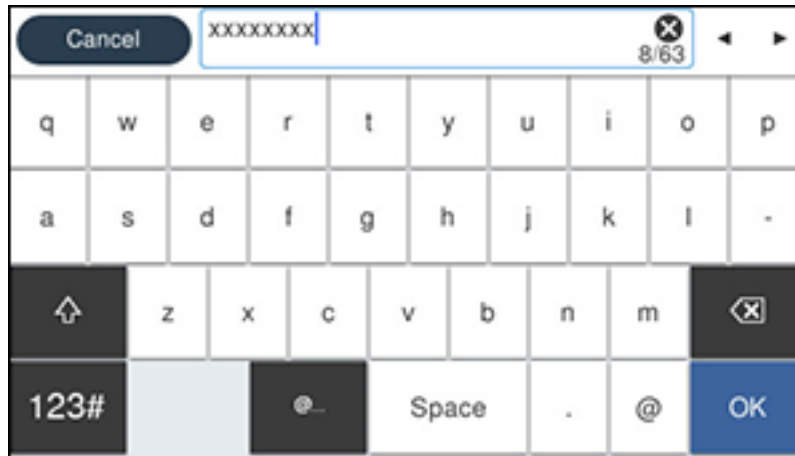
Follow these guidelines to enter characters for passwords and other settings.



- To move the cursor, select the left or right arrows.
- To change the case of letters, select .
- To delete the previous character, select .
- To enter numbers or symbols, select .
- To enter a space, select **Space**.

Parent topic: [Using the Control Panel](#)

Viewing Animations

You can view animations on the LCD screen to help guide you with a procedure or to troubleshoot a problem.

1. Select the ⓘ help icon.
2. Select **Troubleshooting** if you are experiencing a problem or **How To** to view instructions on common procedures.
3. Select a topic from the list of available topics and follow the on-screen instructions.

Parent topic: [Using the Control Panel](#)

Selecting the Date and Time

Before faxing, select the current date, time, and daylight saving phase in your area, and choose your preferred date and time format.

1. Press the 🏠 home button, if necessary.
2. Select **Settings**.
3. Select **General Settings**.



4. Select **Basic Settings**.
5. Select **Date/Time Settings**.

You see a screen like this:

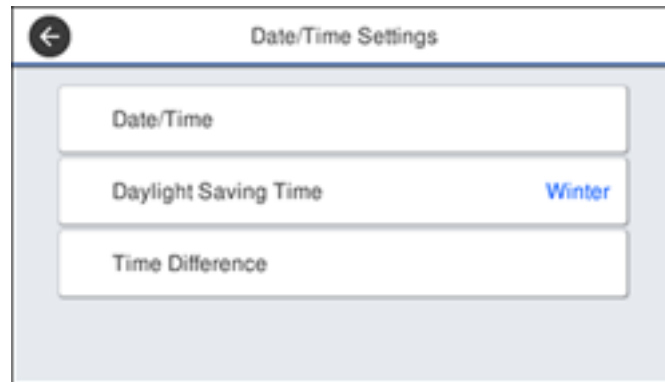

6. Select **Daylight Saving Time**.
7. Select the setting that applies to your area:
 - **Winter**: it is winter or your region does not use Daylight Saving Time (DST)
 - **Summer**: it is spring or summer and your region uses Daylight Saving Time (DST)

Note: If your region uses Daylight Saving Time (DST), you must change this setting to match the season. When you change from **Winter** to **Summer**, your product automatically sets its clock ahead one hour. When you change from **Summer** to **Winter**, it sets its clock back one hour.

8. Select **Date/Time**.
9. Select the date format you want to use.
10. Use the numeric keypad to enter the current date.
11. Select the time format you want to use.
12. Use the numeric keypad to enter the current time.

Parent topic: [Using the Control Panel](#)

Selecting Your Country or Region

Before using your product, select the country or region in which you are using your product.

Note: If you change the country or region, your fax settings return to their defaults and you must select them again. This setting can be locked by an administrator. If you cannot access or change this setting, contact your administrator for assistance.

1. Press the  home button, if necessary.
2. Select **Settings** > **General Settings** > **Basic Settings** > **Country/Region**.

You see a screen like this:

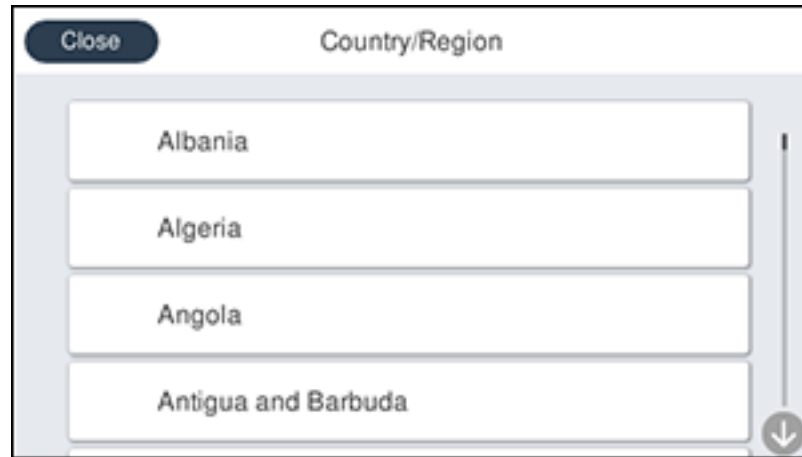

3. Scroll up or down, if necessary, and select your country or region.
You see a confirmation screen.
4. If the setting is correct, select **Yes**. (If not, select **No** and retry.)

Parent topic: [Using the Control Panel](#)

Using Presets

You can save frequently used copy, fax, and scan settings as presets. This lets you easily reuse them whenever necessary.

1. Press the  home button, if necessary.
2. Select **Presets**.

You see a screen like this:

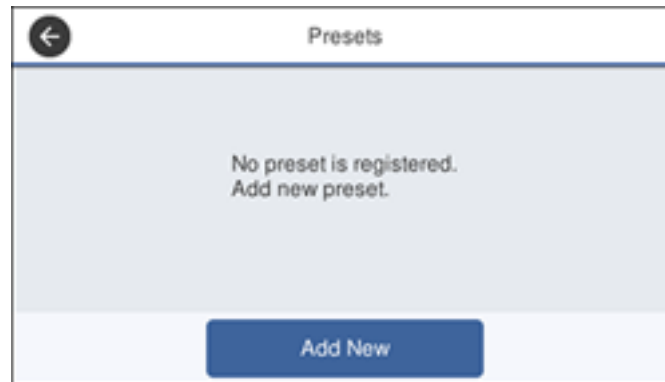

3. Select **Add New**.
4. Select the function for which you want to set up a preset.

You see the main screen for that function, such as the Copy screen:

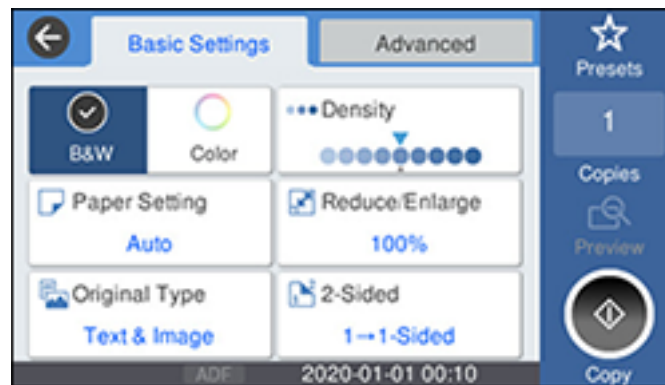

5. Select the settings you want to save and select **Register**.

You see a screen like this:



6. Select **Name**.
7. Use the displayed keyboard to enter a name for the preset and select **OK**.
8. Select **OK**.

When you copy, fax, or scan, you can use the preset by selecting **Presets** and selecting your preset name from the list.

Parent topic: [Using the Control Panel](#)

Related tasks

[Entering Characters on the LCD Screen](#)

Changing LCD Screen Language

You can change the language used on the LCD screen.

1. Press the  home button, if necessary.
2. Select **Settings**.
3. Select **General Settings**.

You see a screen like this:



4. Select **Basic Settings**.
5. Scroll down and select **Language**.
6. Select a language.

Parent topic: [Using the Control Panel](#)

Adjusting Control Panel Sounds

You can adjust the sound level heard when you press buttons on the control panel.



1. Press the  home button, if necessary.
2. Select **Settings**.
3. Select **General Settings**.

You see a screen like this:



4. Select **Basic Settings**.
5. Select **Sounds**.
6. Select **Normal Mode** or **Quiet Mode**.

Note: Press the  icon on the home screen to switch between Normal Mode and Quiet Mode.

7. Select **Button Press**.
8. Press  to decrease or  to increase the sound.
9. Select **OK** to exit.

Note: You can also adjust the **Sound Type** and the sound level for various product functions.

Parent topic: [Using the Control Panel](#)

Adjusting the Screen Brightness

You can adjust the brightness of the LCD screen.

1. Press the  home button, if necessary.
2. Select **Settings**.
3. Select **General Settings**.

You see a screen like this:



4. Select **Basic Settings**.
5. Select **LCD Brightness**.
6. Do one of the following:
 - Press the – or + icons to decrease or increase the brightness.
 - Press the brightness level on the LCD screen, select a number from the on-screen keypad, and press **OK**.
7. Select **OK** to exit.

Parent topic: [Using the Control Panel](#)

Turning Off the Operation Time Out Setting

The Operation Time Out setting causes the LCD screen to return to the Home screen after a few minutes of inactivity. This feature is enabled by default, but you can turn it off.

1. Press the  home button, if necessary.
2. Select **Settings**.
3. Select **General Settings**.

You see a screen like this:



4. Select **Basic Settings**.
5. Scroll down and set **Operation Time Out** to **Off**.

Parent topic: [Using the Control Panel](#)

Preventing PC Connection via USB

You can disable access from a USB-connected computer. This restricts non-network access to the product and protects the security of confidential scanned documents.

1. Press the  home button, if necessary.
2. Select **Settings**.
3. Select **General Settings**.

You see a screen like this:



4. Select **Printer Settings**.

You see a screen like this:



5. Scroll down and select **PC Connection via USB**.
6. Select **Disable**.

Parent topic: [Using the Control Panel](#)

Product Parts Locations

See these sections to identify the parts on your product.

[Product Parts - Front](#)

[Product Parts - Inside](#)

[Product Parts - Back](#)

Parent topic: [Product Basics](#)

Product Parts - Front

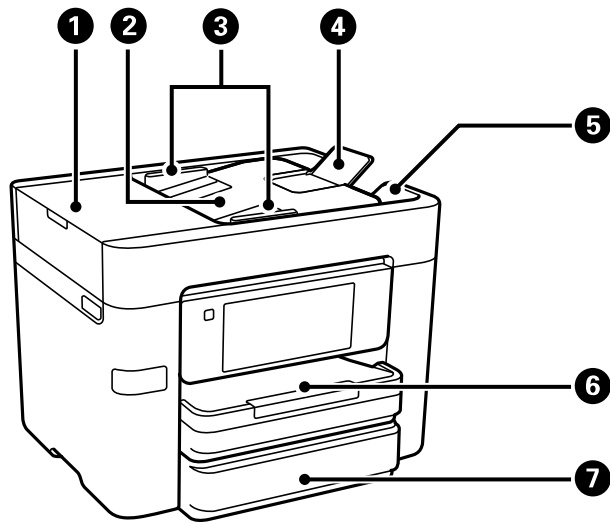

- 1 Automatic Document Feeder (ADF) cover
- 2 ADF input tray
- 3 ADF edge guides
- 4 ADF document support
- 5 ADF output tray
- 6 Paper cassette 1

7 Paper cassette 2

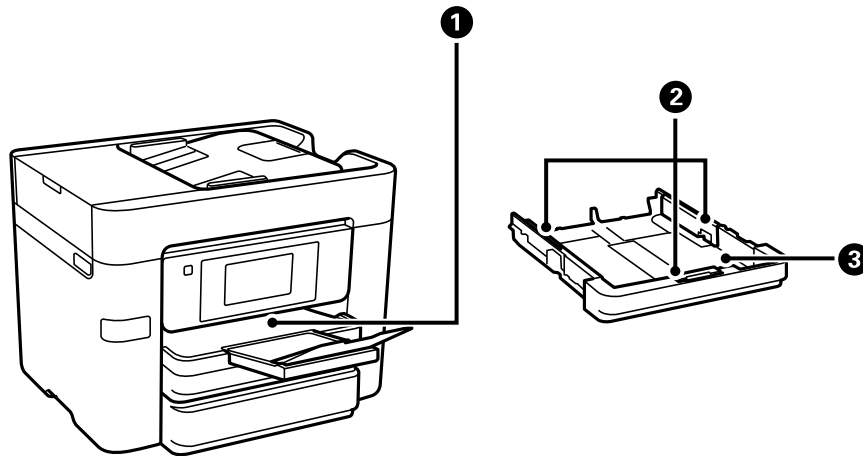

- 1 Output tray
- 2 Paper cassette edge guides
- 3 Paper cassette

Parent topic: [Product Parts Locations](#)

Product Parts - Inside

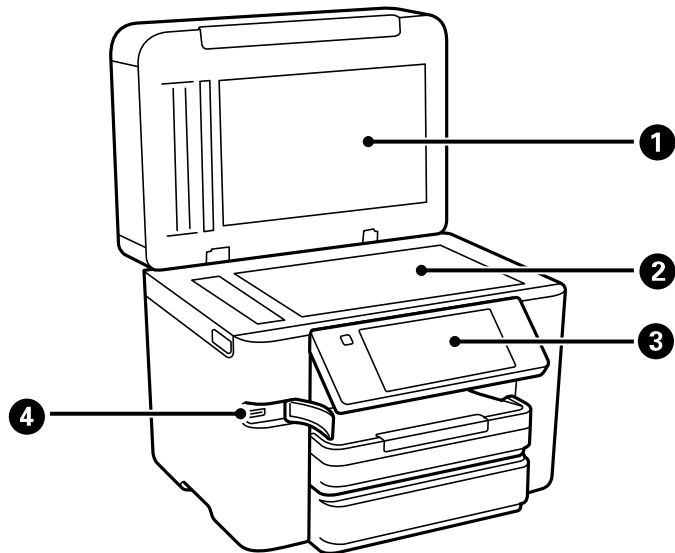

- 1 Document cover
- 2 Scanner glass
- 3 Control panel

4 USB Type A port for external devices

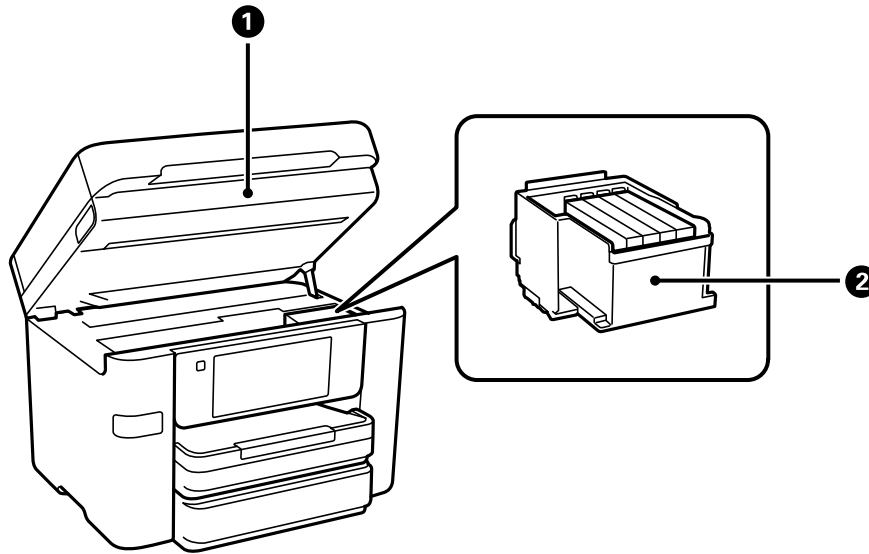

- 1 Scanner unit
- 2 Ink cartridge holder (do not remove)

Parent topic: [Product Parts Locations](#)

Product Parts - Back

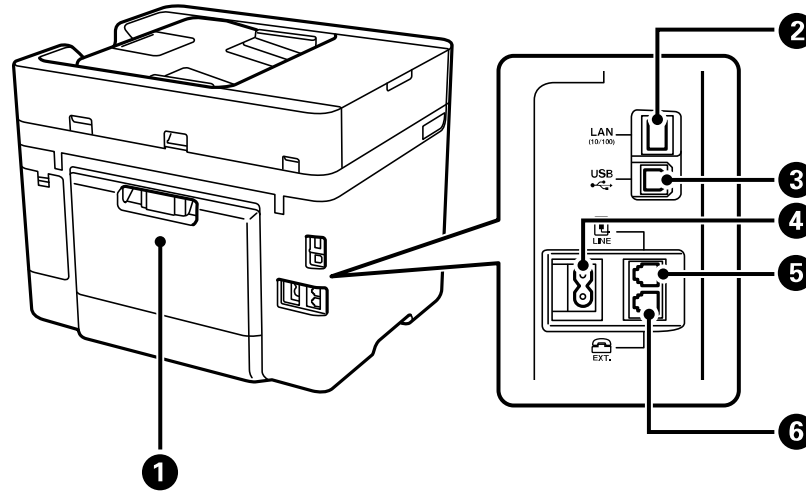

- 1 Rear cover
- 2 **LAN** port
- 3 **USB** port
- 4 AC inlet
- 5 **LINE** port
- 6 **EXT** port



Parent topic: [Product Parts Locations](#)

Checking for Software Updates

It's a good idea to check Epson's support website occasionally for free updates to your product software. Visit epson.com/support (U.S.) or epson.ca/support (Canada) and select your product.

Note: Your printer is designed to work only with genuine Epson-brand ink cartridges. Other brands of ink cartridges and ink supplies are not compatible and, even if described as compatible, may not function properly or at all. Epson periodically provides firmware updates to address issues of security, performance, minor bug fixes and ensure the printer functions as designed. These updates may affect

the functionality of third-party ink. Non-Epson branded or altered Epson cartridges that functioned prior to a firmware update may not continue to function.

- **Windows:** Your printer software automatically checks for updates. You can also manually update the software by selecting **Software Update** here:
 - Accessing the Windows Desktop and right-clicking the  icon for your product in the right side of the Windows taskbar, or clicking the up arrow and right-clicking .
 - On the **Maintenance** tab in the printer settings window

You can also update the software by selecting **EPSON Software Updater** in the **EPSON** or **Epson Software** program group, accessible by the **Start** button, or on the **Start** or **Apps** screens, depending on your version of Windows.

- **OS X:** You can manually update the software by opening the **Applications** > **Epson Software** folder and selecting **EPSON Software Updater**.
- **macOS 10.12.x, 10.13.x, 10.14.x, 10.15.x, 11.x, or 12.x:** You can manually update the software by opening the **App Store**, selecting **Updates**, searching for a software update option for Epson Software, and selecting **Update**.

Parent topic: [Product Basics](#)
[Solving Problems](#)

Using Power Saving Settings

Your product enters sleep mode automatically and turns off the LCD screen if it is not used for a period of time. You can make the time period shorter and select other options to save energy and resources.

[Changing the Sleep Timer Settings](#)

[Changing the Power Off Timer Settings](#)

Parent topic: [Product Basics](#)

Changing the Sleep Timer Settings

You can adjust the time period before your product enters sleep mode and turns off the LCD screen.

1. Press the  home button, if necessary.
2. Select **Settings**.
3. Select **General Settings**.

You see a screen like this:



4. Select **Basic Settings**.

5. Select **Sleep Timer**.

You see a screen like this:

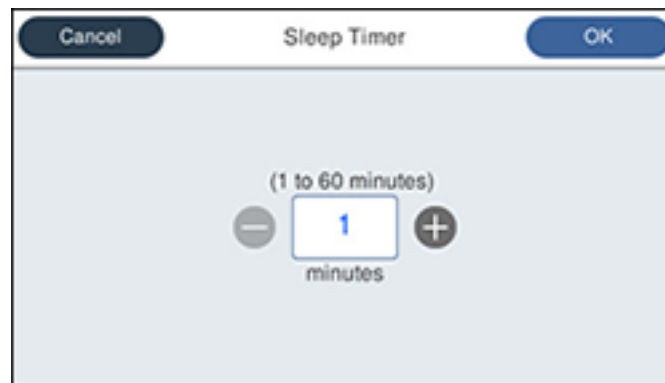

6. Do one of the following:

- Press the – or + icon to decrease or increase the number of minutes.
- Press the number of minutes on the LCD screen, select the number of minutes from the on-screen keypad, and press **OK**.

7. Select **OK**.
8. Select **Wake from Sleep**.
9. Select **Wake with LCD Screen Touch**.
10. Do one of the following:
 - Select **On** to wake the printer from sleep mode by tapping the LCD touchscreen or by pressing a button on the control panel.
 - Select **Off** to wake the printer from sleep mode by only pressing a button on the control panel. This prevents unintentional operations due to objects bumping the LCD touchscreen.
 - Select **Scheduled** to set a time range for the feature to be enabled.

Parent topic: [Using Power Saving Settings](#)

Changing the Power Off Timer Settings

You can have the product turn off automatically if it is not used for a specified period of time.

1. Press the  home button, if necessary.
2. Select **Settings**.
3. Select **General Settings**.

You see a screen like this:



4. Select **Basic Settings**.
5. Select **Power Off Timer**, then select a time period between **30minutes** and **12h** (12 hours).

Parent topic: [Using Power Saving Settings](#)

Epson Connect Solutions for Smartphones, Tablets, and More

Use your smartphone, tablet, or computer to print and scan documents, photos, emails, and web pages from your home, office, or even across the globe.

Note: If you are using your Epson product with the Windows 10 S operating system, you cannot use the software described in this section. You also cannot download and install any Epson product software from the Epson website for use with Windows 10 S; you must obtain software only from the Windows Store.

Print from anywhere with these Epson Connect solutions:

- Epson Email Print
- Epson iPrint Mobile App
- Epson Remote Print

Scan and send a file as an email or upload it to an online service directly from your Epson product with Epson Scan to Cloud or the Epson iPrint Mobile App.

[Setting Up Epson Connect Services](#)

[Using Epson Email Print](#)

[Using the Epson Smart Panel Mobile App](#)

[Using the Epson iPrint Mobile App](#)

[Using Epson Remote Print](#)

[Using Epson Scan to Cloud](#)

Parent topic: [Product Basics](#)

Related topics

[Wi-Fi or Wired Networking](#)

Setting Up Epson Connect Services

If you did not activate your product's email address for use with Epson Connect when you set up your product, you can activate it using the product control panel.

1. Press the  home button, if necessary.
2. Select **Settings**.
3. Select **General Settings**.

You see a screen like this:



4. Select **Web Service Settings**.
5. Select **Epson Connect Services**.

You see a screen like this:



6. Select **Register**.
7. Follow the instructions on the screen to activate your product's email address.

Parent topic: [Epson Connect Solutions for Smartphones, Tablets, and More](#)

Related topics

[Wi-Fi or Wired Networking](#)

Using Epson Email Print

With Epson Email Print, you can print from any device that can send email, such as your smartphone, tablet, or laptop. Just activate your product's unique email address. When you want to print, attach a PDF, Microsoft Office document, or photo to an email and send it to your product. Both the email and the attachments will print automatically.

1. Connect your product to your network. See the link below.
2. If you did not already set up Email Print when you installed your product software, see the link below to use your product control panel to activate your unique email address. Or visit epson.com/connect (U.S.) or epson.ca/connect (Canada) to learn more about Email Print, create your Epson Connect account, and register your product to the Epson Connect service.
3. Now you are ready to send and print emails to your product's Email Print address.

Note: Go to epsonconnect.com and log into your Epson Connect account to personalize your product's email, adjust print settings, and set up other Epson Connect services.

Parent topic: [Epson Connect Solutions for Smartphones, Tablets, and More](#)

Related topics

[Wi-Fi or Wired Networking](#)

Using the Epson Smart Panel Mobile App

Use this free Apple and Android app to set up your Epson product and then print, copy, or scan with your networked Epson product. Epson Smart Panel also lets you check ink levels and product status.

1. Visit epson.com/connect (U.S.) or epson.ca/connect (Canada) to learn more about Epson Smart Panel and check the compatibility of your mobile device.
2. Download Epson Smart Panel from the Apple App Store or Google Play.
3. Connect your mobile device to the wireless network that you want to connect your product to or to the same wireless network as your product (if your product is already set up).
4. Do one of the following:
 - If you haven't set up your product, open Epson Smart Panel and follow the instructions to set up your product.

- If your product is already set up, open Epson Smart Panel and select your Epson product, if necessary.

Now you are ready to print, copy, or scan with your mobile device and your Epson product.

Parent topic: [Epson Connect Solutions for Smartphones, Tablets, and More](#)

Related tasks

[Setting Up Wireless Printing from a Smart Device Using Epson Smart Panel](#)

[Printing from a Smartphone or Tablet](#)

[Starting a Scan from a Smartphone or Tablet](#)

Related topics

[Wi-Fi or Wired Networking](#)

Using the Epson iPrint Mobile App

Use this free Apple and Android app to print and scan with networked Epson products. Epson iPrint lets you print PDFs, Microsoft Office documents, photos, and web pages over a wireless network. You can scan and save a file on your device, send it as an email, or upload it to an online service such as Box, Dropbox, Evernote, or Google Drive.

1. Connect your product to your wireless network. See the link below.
2. Visit epson.com/connect (U.S), epson.ca/connect (Canada), or latin.epson.com/connect (Caribbean) to learn more about Epson iPrint and check the compatibility of your mobile device.
3. Download Epson iPrint from the Apple App Store or Google Play.
4. Connect your mobile device to the same wireless network as your product.
5. Open Epson iPrint and select your Epson product.

Now you are ready to print or scan with your mobile device and your Epson product.

Parent topic: [Epson Connect Solutions for Smartphones, Tablets, and More](#)

Related topics

[Wi-Fi or Wired Networking](#)

Using Epson Remote Print

With Epson Remote Print software, you can print from your laptop or desktop computer to an Epson Email-enabled product anywhere in the world.

1. Connect your Epson product to your wireless network. See the link below.

2. If you did not already set up an Epson Connect account when you installed your product software, visit epsonconnect.com to create your account and register your product to the Epson Connect service.

Note: Make a note of your product's email address.

3. Visit epsonconnect.com to learn more about Remote Print and how to download the Remote Print Driver software.
4. Download and install the Remote Print software.
5. Enter the email address and optional access key of your Epson product during Remote Print setup.
6. Now you are ready to print remotely. Select the print command in your laptop or desktop computer application and choose the Remote Print option for your Epson product.

Parent topic: [Epson Connect Solutions for Smartphones, Tablets, and More](#)

Related topics

[Wi-Fi or Wired Networking](#)

Using Epson Scan to Cloud

The Epson Scan to Cloud service allows you to scan and send a file as an email or upload it to an online service directly from your Epson product. Register an email address or online services such as Box, DropBox, Evernote, or Google Drive with your Epson Connect account.

1. Connect your Epson product to your network. See the link below.
2. If you did not already set up an Epson Connect account when you installed your product software, visit epsonconnect.com to create your account and register your product to the Epson Connect service.

Note: Make a note of your product's email address and password.

3. Visit epsonconnect.com to sign into your account with the email address and password you selected.
4. Select your product, select **Scan to Cloud**, and select **Destination List**.
5. Click **Add**, then follow the instructions on the screen to create your destination list.
6. Now you are ready to use Scan to Cloud. Select the setting for scanning to Scan to Cloud on your Epson product control panel.

Parent topic: [Epson Connect Solutions for Smartphones, Tablets, and More](#)

Related topics

[Wi-Fi or Wired Networking](#)

Using AirPrint

AirPrint enables instant wireless printing from iPhone, iPad, iPod touch, and Mac without the need to install drivers or download software.



Note: If you disabled paper configuration messages on your product control panel, you cannot use AirPrint. See the link below to enable the messages, if necessary.

1. Load paper in your product.
2. Set up your product for wireless printing. See the link below.
3. Connect your Apple device to the same wireless network that your product is using.
4. Print from your device to your product.

Note: For details, see the AirPrint page on the Apple website.

Parent topic: [Product Basics](#)

Related references

[Paper Source Settings Options](#)

Related topics

[Wi-Fi or Wired Networking](#)

Setting Up Printing on a Chromebook

Your Epson printer supports native printing on Chromebook, allowing you to print from a Chromebook without drivers or cables.

For directions on setting up your printer, visit [Setting Up Your Epson Printer on Your Chromebook \(U.S.\)](#) or [Setting Up Your Epson Printer on Your Chromebook \(Canada\)](#).

Parent topic: [Product Basics](#)

Android Printing Using the Epson Print Enabler

You can wirelessly print your documents, emails, photos, and web pages right from your Android phone or tablet (Android v4.4 or later). With a few taps, your Android device will discover your nearby Epson product and print.

1. Connect your Epson product to your wireless network. See the link below.
2. On your Android device, download the Epson Print Enabler plug-in from Google Play.
3. Go to **Settings** on your Android device, select **Printing**, and enable the Epson plug-in, if necessary.
4. Connect your Android device to the same wireless network as your product.
5. Now you are ready to print. From an Android application such as Chrome or Gmail, tap the menu icon and print whatever is on the screen.

Note: If you do not see your product, tap **All Printers** and select your product.

Parent topic: [Product Basics](#)

Related topics

[Wi-Fi or Wired Networking](#)

Using the Mopria Print Service

You can use the Mopria Print Service to print from your Android phone or tablet (Android v4.4 or later) to your Epson product or any Mopria-certified product from other manufacturers. You can download the Mopria Print Service from Google Play.

Note: For details on the Mopria Print Service, [click here](#) (U.S.) or [click here](#) (Canada).

1. Connect your Epson product to your wireless network. See the link below.
2. On your Android device, download the Mopria Print Service app from Google Play.

Note: On some Samsung Galaxy devices, Mopria may come preinstalled.

3. Go to **Settings** on your Android device, select **Printing**, and enable the Mopria Print Service, if necessary.
4. Connect your Android device to the same wireless network as your product.

5. Now you are ready to print. From an Android application such as Chrome or Gmail, tap the menu icon and select **Print**. Then select **All printers**, select your Epson product, adjust your print settings, and print.

Parent topic: [Product Basics](#)

Using Fire OS Printing

You can wirelessly print from Amazon Fire tablets and phones to your nearby networked Epson product. There is no software to download, no drivers to install, and no cables to connect. With just a few taps in Email, Calendar, Contacts, and WPS Office, you can send whatever is on the screen to an Epson product.

1. Connect your Epson product to your wireless network. See the link below.
2. Connect your Amazon device to the same wireless network as your product.
3. Now you are ready to print. From your Amazon application, tap the print option and select your product to print whatever is on the screen.

Note: If you see a message telling you that a plug-in is required, tap **OK** and tap **Download**. If your Amazon Fire product uses Fire OS 5 and above, your device automatically uses the built-in Mopria Print Service app to print.

Parent topic: [Product Basics](#)

Related topics

[Wi-Fi or Wired Networking](#)

Using Windows 10 Mobile Printing

You can wirelessly print from Windows 10 Mobile tablets and phones to your nearby networked Epson product. There is no software to download, no drivers to install, and no cables to connect. Look for the print option in your Windows 10 application to send whatever is on the screen to an Epson product.

1. Connect your Epson product to your wireless network. See the link below.
2. Connect your Windows 10 Mobile device to the same wireless network as your product.
3. Now you are ready to print. From your Windows 10 application, tap the print option and select your product to print whatever is on the screen.

Parent topic: [Product Basics](#)

Related topics

[Wi-Fi or Wired Networking](#)

Using Epson Print and Scan App with Windows Tablets

You can use this free app to print photos and scan from your Windows (Windows 8 or higher) Surface RT or Pro tablet with networked Epson products. The Epson Print and Scan app allows you to scan and capture images right to your tablet or to Microsoft OneDrive.

Note: The Epson Print and Scan app does not support Windows 10 Mobile printing and does not supply scanning functions for products without scanners.

1. Connect your Epson product to your wireless network. See the link below.
2. Download the Epson Print and Scan app from the Microsoft Windows Store.
3. Connect your Windows tablet to the same wireless network as your product.
4. Open the Epson Print and Scan app and select your Epson product.

Now you are ready to print photos or scan.

Parent topic: [Product Basics](#)

Related topics

[Wi-Fi or Wired Networking](#)

Voice-activated Printing

Take advantage of voice-activated, hands-free printing from your Epson product with Alexa, Siri, and Google Assistant. Depending on which voice assistant you use, you can ask your product to print photos, calendars, recipes, photo props, and more. [Click here](#) for more information.

1. Connect your product to your network. See the link below.
2. Do one of the following:
 - Alexa or Google Assistant: Set up your product's email address for use with Epson Connect. See the link below to activate it from the product control panel.
 - Siri: Download and install the Epson iPrint app then select your product. See the link below for instructions.
3. [Click here](#) for instructions on how to set up your product and voice assistant to use the voice-activated printing feature.

Now you are ready to print with your voice and your Epson product.

Parent topic: [Product Basics](#)

Related topics

[Wi-Fi or Wired Networking](#)

Wi-Fi or Wired Networking

See these sections to use your product on a Wi-Fi or wired network.

[Network Security Recommendations](#)

[Wi-Fi Infrastructure Mode Setup](#)

[Wi-Fi Direct Mode Setup](#)

[Wi-Fi Protected Setup \(WPS\)](#)

[Printing a Network Status Sheet](#)

[Printing a Network Connection Report](#)

[Configuring Email Server Settings](#)

[Changing or Updating Network Connections](#)

Network Security Recommendations

To help deter unauthorized access to your product over a network, you should protect your network environment using appropriate security measures.

Security measures such as these can help deter threats such as loss of user data, use of telephone and fax lines, and other intrusions:

- **Enable security on your wireless LAN**

Enable the appropriate security on the wireless LAN you plan to use with your product. Network security such as a network password can deter interception of traffic over the wireless LAN. Your router may already have a default password enabled by your Internet service provider (ISP). See your ISP and router documentation for instructions on how to change the default password and better secure your network.

- **Connect your product only to a network protected by a firewall**

Connecting your product directly to the Internet may leave it vulnerable to security threats. Instead, connect it to a router or other network connection protected by a firewall. Your router may already have a firewall set up by your Internet service provider; check with your ISP for confirmation. For best results, set up and use a private IP address for your network connection.

- **Change the default administrator password on your product**

If your product has an option to set an administrator password, change the default administrator password to deter access by unauthorized users to personal data stored on your product, such as IDs, passwords, and contact lists.

Parent topic: [Wi-Fi or Wired Networking](#)

Wi-Fi Infrastructure Mode Setup

You can set up your product to communicate with your computer using a wireless router or access point. The wireless router or access point can be connected to your computer over a wireless or wired network.

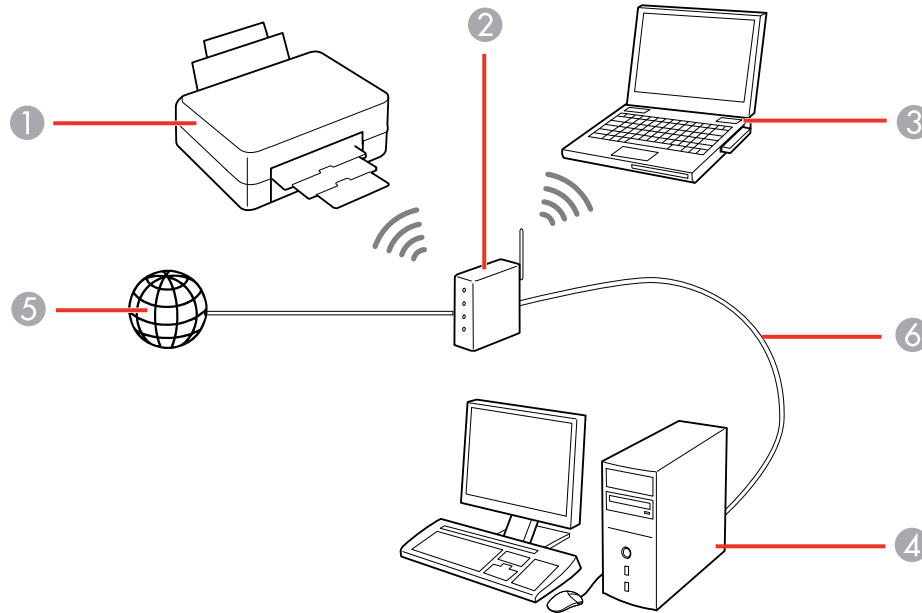

- 1 Epson product
- 2 Wireless router or access point
- 3 Computer with a wireless interface
- 4 Computer
- 5 Internet
- 6 Ethernet cable (used only for wired connection to the wireless router or access point)

[Selecting Wireless Network Settings from the Control Panel](#)

[Setting Up Wireless Printing from a Smart Device Using Epson Smart Panel](#)



Parent topic: [Wi-Fi or Wired Networking](#)

Selecting Wireless Network Settings from the Control Panel

You can select or change wireless network settings using your product control panel.

To install your product on a wireless network, follow the instructions on the *Start Here* sheet and install the necessary software by downloading it from the Epson website. The installer program guides you through network setup.

Note: Breakdown or repair of this product may cause loss of fax and network data and settings. Epson is not responsible for backing up or recovering data and settings during or after the warranty period. We recommend that you make your own backup or print out your fax and network data and settings.

1. Press the  home button, if necessary.
2. Press the   icon.

You see a screen like this:

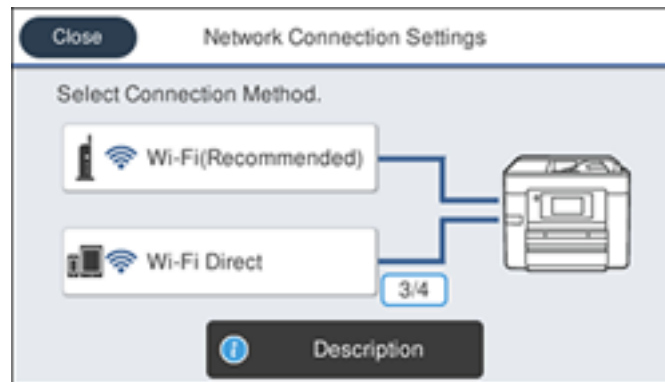





3. Select **Wi-Fi (Recommended)**.
4. Select **Start Setup** or **Change Settings**.
5. Select **Wi-Fi Setup Wizard**.
6. Select the name of your wireless network or select **Enter Manually** to enter the name manually. Use the displayed keypad to enter your network name.

7. Select the **Password** field and enter your wireless password using the displayed keypad.



Note: The network name and password are case sensitive. Be sure to correctly enter uppercase and lowercase letters, and numeric or special characters.

- To move the cursor, press the left or right arrows.
 - To change the case of letters, press .
 - To delete the previous character, press .
 - To enter numbers and symbols, press .
 - To enter a space, press **Space**.
8. Press **OK** when you finish entering your password.
 9. Confirm the displayed network settings and select **Start Setup** to save them.
 10. If you want to print a network setup report, select **Print Check Report**. (Otherwise, select **OK**.)
 11. Press the  home button to exit.

You see the  icon on the LCD screen and should be able to connect to your product directly from your computer or device, and then print. If you are printing from a computer, make sure you installed the network software as described on the *Start Here* sheet.

Note: If you don't see the  icon, you may have selected the wrong network name or entered the password incorrectly. Repeat these steps to try again.

Parent topic: [Wi-Fi Infrastructure Mode Setup](#)

Related references

[Status Icon Information](#)

Related tasks

[Entering Characters on the LCD Screen](#)

Setting Up Wireless Printing from a Smart Device Using Epson Smart Panel

You can use the Epson Smart Panel app to connect your Epson product to a wireless network or connect your smart device directly to the product. Epson Smart Panel is available on iOS and Android devices.

Make sure you have the following:

- A Bluetooth-enabled device that is connected to a wireless network
- The Epson Smart Panel app installed on the device
- The wireless network name (SSID) and password

Note: Your device must be close enough to the product to create and maintain a Bluetooth connection.

1. Make sure the product is turned on and is ready to print.

Note: You must perform initial setup and ink installation before setting up wireless printing.

2. Open the Epson Smart Panel app on your device.
3. Do one of the following:
 - If the app automatically recognizes the product, follow the on-screen instructions to set up the wireless connection.
 - If the app does not automatically recognize the product, select the **+** icon and continue with the next step.
4. On the next screen, select **Connect to a New Product**.

5. Select your product from the list.

Note: If your product is not listed, move closer to the product and try again. If the product is still not shown, connect your printer to the wireless network using the control panel and then select **Connect to Existing Product** in the Epson Smart Panel app and follow the on-screen instructions. See the link below for wireless setup instructions.

6. Select **Next** to select the current wireless network.

Note: If you want to connect the product to a different wireless network, select **Change another Wi-Fi SSID**.

7. Enter the password for the wireless network and select **OK**.

The app starts configuring the product.

Note: Do not move the smart device away from the product during configuration. The product's control panel may show a successful wireless connection before the process is completed on your device. Wait for the completion message in the Epson Smart Panel app and do not cancel the configuration before it is completed.

Your product is now connected to a wireless network and set up for use with the Epson Smart Panel app.

Parent topic: [Wi-Fi Infrastructure Mode Setup](#)

Related tasks

[Using the Epson Smart Panel Mobile App](#)

[Printing from a Smartphone or Tablet](#)

[Starting a Scan from a Smartphone or Tablet](#)

Wi-Fi Direct Mode Setup

You can set up your product to communicate directly with your computer or another device without requiring a wireless router or access point. In Wi-Fi Direct Mode, the product itself acts as a network access point for up to 8 devices.

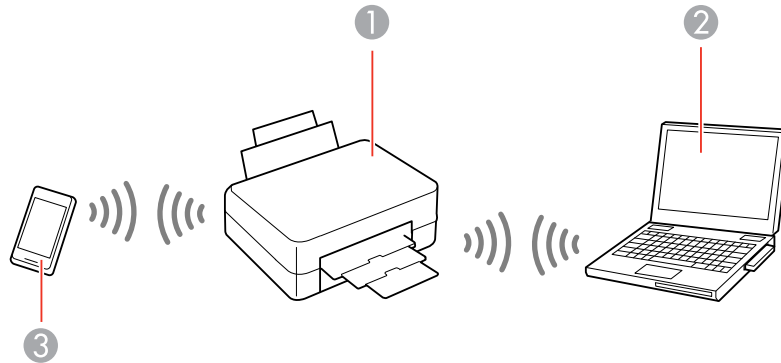

- 1 Epson product
- 2 Computer with a wireless interface
- 3 Other wireless device

[Enabling Wi-Fi Direct Mode \(Simple AP\)](#)

[Enabling Wi-Fi Direct Mode](#)

[Modifying the Wi-Fi Direct Network Name or Password](#)

Parent topic: [Wi-Fi or Wired Networking](#)



Related references

[Status Icon Information](#)

Enabling Wi-Fi Direct Mode (Simple AP)

You can enable Wi-Fi Direct mode to allow direct communication between your product and computer, mobile devices, or other devices (up to 8) without a wireless router or access point.

Note: Make sure the Epson iPrint app or another compatible Epson printing app is installed on your mobile device before connecting to the product.

1. Press the  home icon, if necessary.
2. Select the   icon.

You see a screen like this:

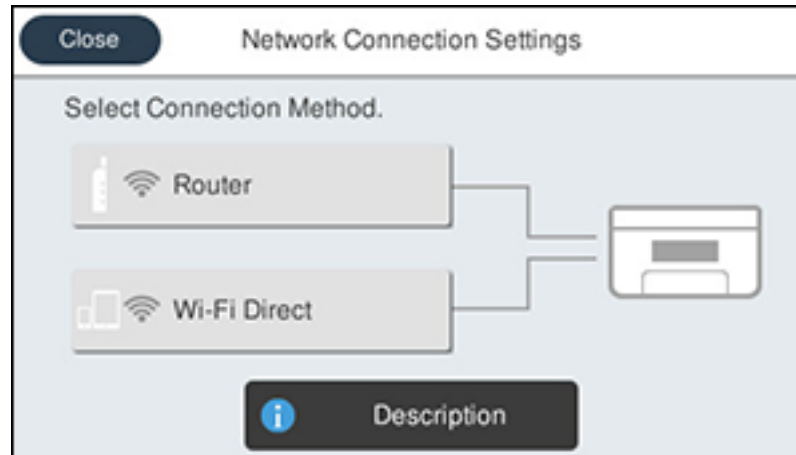

3. Select **Wi-Fi Direct**.
4. Select **Start Setup**.

You see this screen:

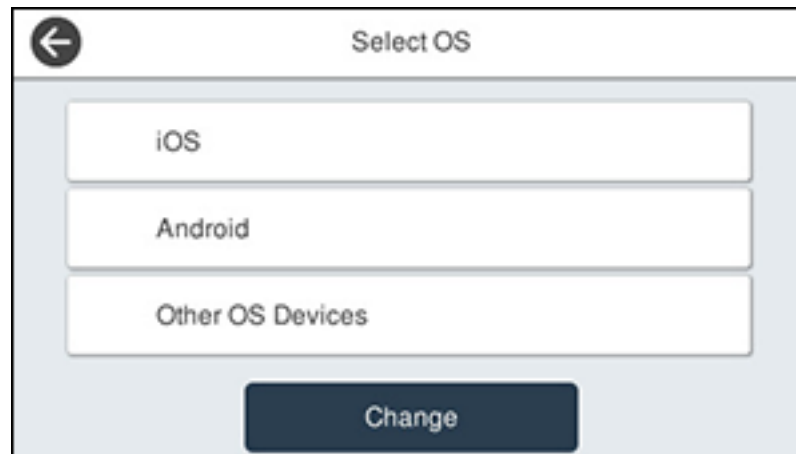



5. Do one of the following to complete Wi-Fi Direct setup:
 - For iOS devices, select **iOS**. Scan the QR code with the camera app on your device and follow the instructions on your device. Select **Next** on the LCD screen to display your product information, then open the compatible Epson printing app on your device and select your product. Select **Complete** on the LCD screen.
 - For Android devices, select **Android**. Open the compatible Epson printing app on your device and select your product. Select **Complete** on the LCD screen.
 - For other types of devices, select **Other OS Devices**. Use your device to select the Wi-Fi network name (SSID) displayed on the LCD screen and enter the password shown. Select **Next** on the LCD screen to display your product information, then follow the instructions on the LCD screen.

The  Wi-Fi Direct icon is displayed on the LCD screen and indicates if Wi-Fi Direct is enabled on the product.

Parent topic: [Wi-Fi Direct Mode Setup](#)

Enabling Wi-Fi Direct Mode

You can enable Wi-Fi Direct mode to allow direct communication between your product and computer or other devices without a wireless router or access point.

1. Press the  home button, if necessary.
2. Press the  icon.

You see a screen like this:

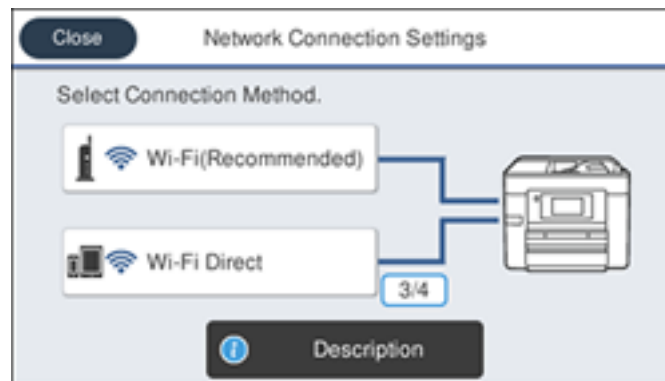



3. Select **Wi-Fi Direct**.
4. Scroll down and select **Start Setup**.
5. Select **Start Setup** again.

You see a screen like this:



6. Use your computer or wireless device to select the Wi-Fi network name (SSID) displayed on the LCD screen, then enter the password shown.
7. Press the  home button to exit.

You see the   icon on the LCD screen and should be able to connect to your product directly from your computer or device, and then print. If you are printing from a computer, make sure you installed the network software as described on the *Start Here* sheet.

Note: If you don't see the  icon on the LCD screen, you may have selected the wrong network name or entered the password incorrectly. Repeat these steps to try again.

Parent topic: [Wi-Fi Direct Mode Setup](#)

Related references

[Status Icon Information](#)



Related tasks

[Entering Characters on the LCD Screen](#)

Modifying the Wi-Fi Direct Network Name or Password

You can modify the Wi-Fi Direct name and password to create a more descriptive and secure Wi-Fi Direct network.

Note: If you are printing from a computer, make sure you installed the network software as described on the *Start Here* sheet.

1. Press the  home button, if necessary.
2. Select the  icon.

You see a screen like this:

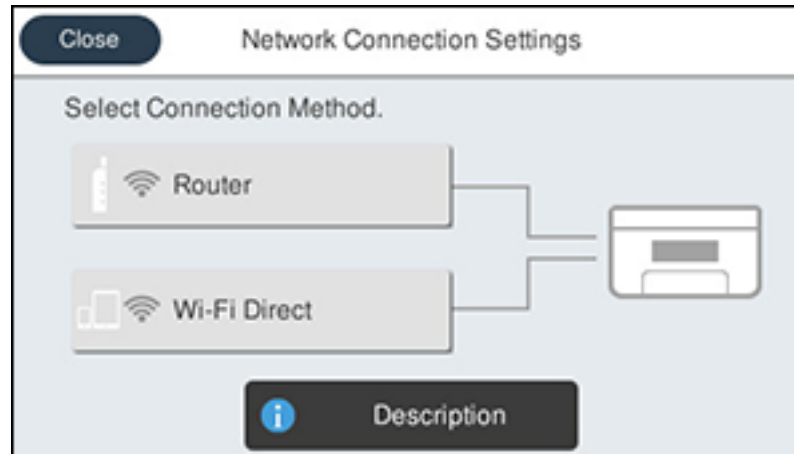

3. Select **Wi-Fi Direct**.
4. Select **Start Setup**.
5. Select **Change**.

You see this screen:





6. Do one of the following:

- To change the Wi-Fi Direct network name, select **Change Network Name** and select **Yes**. Select **Change**, then use the on-screen keyboard to enter the new network name.
- To change the Wi-Fi Direct password, select **Change Password** and select **Yes**. Use the on-screen keyboard to enter your new Wi-Fi Direct password.

Note: Your password must be at least 8 and no more than 22 characters long.

Note: If you have already connected devices or computers to your product via Wi-Fi Direct, they will be disconnected when you change the network name or password.

7. When entering your Wi-Fi Direct network name or password, do the following:

- To move the cursor, press the left or right arrow.
- To change the case of letters, select .
- To delete the previous character, select .
- To enter numbers and symbols, select .

- To enter a space, select **Space**.
 - To finish entering your network name or password, select **OK**.
8. Use your computer or wireless device to select the Wi-Fi network name (SSID) displayed on the LCD screen, then enter the password shown.

Note: Make a note of the SSID and password that appear.

9. Press the  home button to return to the Home screen.

Computers and wireless devices can now access the product using the new network name and password.

Parent topic: [Wi-Fi Direct Mode Setup](#)

Wi-Fi Protected Setup (WPS)

If your network uses a WPS-enabled wireless router or access point, you can quickly connect your product to the network using Wi-Fi Protected Setup (WPS).



Note: To check if your router is WPS-enabled, look for a button labeled **WPS** on your router or access point. If there is no hardware button, there may be a virtual WPS button in the software for the device. Check your network product documentation for details.

[Using WPS to Connect to a Network](#)

Parent topic: [Wi-Fi or Wired Networking](#)

Using WPS to Connect to a Network

If you have a WPS-enabled wireless router or access point, you can use Wi-Fi Protected Setup (WPS) to connect your product to the network.

1. Press the  home button, if necessary.
2. Press the  icon.

You see a screen like this:

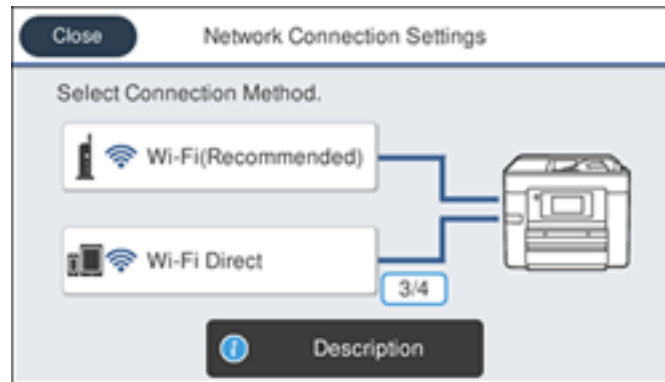

3. Select **Wi-Fi (Recommended)**.
4. Select **Push Button Setup (WPS)**.
5. Follow the instructions on the LCD screen to complete WPS setup.
6. Press the  home button to exit.

You see the  icon on the LCD screen and should be able to connect to your product directly from your computer or device, and then print. If you are printing from a computer, make sure you installed the network software as described on the *Start Here* sheet.

Note: If you don't see the  icon, repeat these steps to try again.

Parent topic: [Wi-Fi Protected Setup \(WPS\)](#)

Printing a Network Status Sheet

You can print a network status sheet to help you determine the causes of any problems you may have using your product on a network.

1. Press the  home button, if necessary.
2. Select **Settings**.
3. Select **General Settings**.

You see a screen like this:



4. Select **Network Settings**.
5. Select **Network Status**.
6. Select **Print Status Sheet**.
7. Select **Print**.

Examine the settings shown on the network status sheet to diagnose any problems you have.

Parent topic: [Wi-Fi or Wired Networking](#)

Printing a Network Connection Report

You can print a network connection report to view solutions to any problems you may have using your product on a network.

1. Press the  home button, if necessary.
2. Select **Settings**.
3. Select **General Settings**.

You see a screen like this:



4. Select **Network Settings**.
5. Select **Connection Check**.
6. Select **Print Check Report**.
7. Select **Print**.

Examine the error codes and solutions shown on the network connection report.

[Network Connection Report Codes and Messages](#)

Parent topic: [Wi-Fi or Wired Networking](#)

Network Connection Report Codes and Messages

Check the error codes and messages on the network connection report to solve problems you may encounter with network connections. The tables here list solutions to problems based on the error codes and messages that may appear on the top of the report.

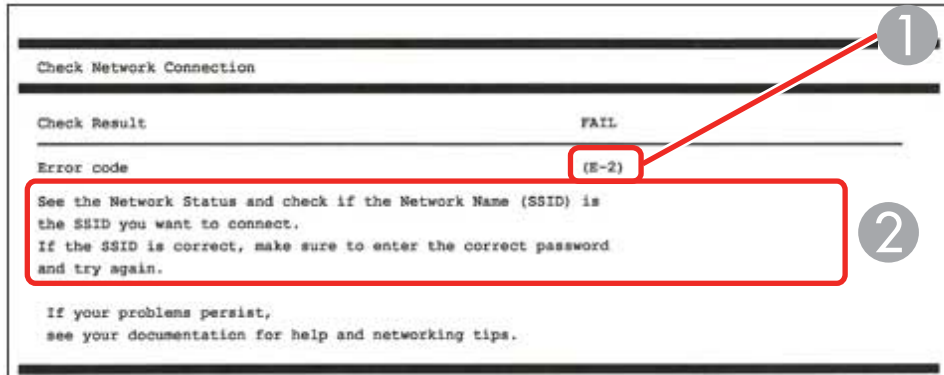

- 1 Error code
- 2 Message

Note: Error codes and messages listed here may not all apply to your product.

Error Codes and Messages

Error code and message	Solution
E-1 Confirm that the network cable is connected and network devices such as hub, router, or access point are turned on.	Make sure your router, access point, and/or hub are turned on, and the network cable is securely connected to your device and to your product. If you are trying to set up Wi-Fi, remove the network cable and set up Wi-Fi again. Ethernet and Wi-Fi cannot be connected at the same time.

Error code and message	Solution
<p>E-2, E-3, or E-7</p> <p>No wireless network names (SSID) found. Confirm that the router/access point is turned on and the wireless network (SSID) is set up correctly. Contact your network administrator for assistance.</p> <p>No wireless network names (SSID) found. Confirm that the wireless network name (SSID) of the PC you wish to connect is set up correctly. Contact your network administrator for assistance.</p> <p>Entered security key/password does not match the one set for your router/access point. Confirm security key/password. Contact your network administrator for assistance.</p>	<p>Check the following:</p> <ul style="list-style-type: none"> • Make sure your router or access point is turned on, and is correctly connected to your computer or network device. • Turn off the router or access point, wait about 10 seconds, and turn it on again. • Move your product closer to your router or access point, and remove any obstacles between them. Also move your product away from devices such as wireless phones or microwaves. • Confirm that the SSID shown on the network connection report matches the label on your router or access point. Also make sure your SSID uses only ASCII characters and symbols, or your product cannot display the SSID correctly. • If you are trying to connect using the WPS push button method, make sure your router or access point supports it. • If you are using a network password, check the label on your router or access point to confirm that you are using the correct password, or check with your network administrator or router/access point documentation. • If you are connecting to a smart device that generates an SSID, check the device documentation for the SSID and password you should use. • If your wireless connection suddenly disconnects, and another smart device was added to the network using a WPS push button method or your network was set up using a non-WPS push button method, try downloading and installing your product software again.

Error code and message	Solution
<p>E-5 Security mode (e.g. WEP, WPA) does not match the current setting of the printer. Confirm security mode. Contact your network administrator for assistance.</p>	<p>If the security on your router or access point is not one of the following types, change the type of security on your router or access point and reset your product's network settings.</p> <ul style="list-style-type: none"> • WEP-64 bit (40 bit) • WEP-128 bit (104 bit) • WPA PSK (TKIP/AES); also known as WPA Personal • WPA2 PSK (TKIP/AES); also known as WPA2 Personal • WPA (TKIP/AES) • WPA2 (TKIP/AES) • WPA3-SAE (AES)
<p>E-6 MAC address of your printer may be filtered. Check whether your router/access point has restrictions such as MAC address filtering. See the documentation of the router/access point or contact your network administrator for assistance.</p>	<p>If your router or access point has MAC address filtering enabled, register your product's MAC address so it is not filtered. Locate the MAC address on the network connection report and check your router or access point documentation for instructions.</p> <p>If your router or access point is using shared authentication with WEP security, confirm that you are using the correct authentication key and index.</p> <p>If your router or access point limits the number of connected devices, raise the connection limit. See your router or access point documentation for instructions.</p>
<p>E-8 Incorrect IP address is assigned to the printer. Confirm IP address setup of the network device (hub, router, or access point). Contact your network administrator for assistance.</p>	<p>If your product's Obtain IP Address setting is set to Auto, enable DHCP on your router or access point. If it is set to Manual, the IP address may be out of range or on a different network segment; set a valid IP address using your product control panel or the Web Config utility.</p> <p>You can also try turning off your product and the router or access point, waiting about 10 seconds, and turning them on again.</p>

Error code and message	Solution
<p>E-9 Confirm the connection and network setup of the PC or other device. Connection using the EpsonNet Setup is available. Contact your network administrator for assistance.</p>	<p>Make sure your computer or network device are turned on. Also make sure that you can access the Internet and other devices on the same network from the devices you are trying to connect to your product.</p> <p>If you still cannot connect to your product, turn off your router or access point, wait about 10 seconds, and turn it on again. Download and install your product software again to reset your network settings.</p>
<p>E-10 Confirm IP address, subnet mask, and default gateway setup. Connection using the EpsonNet Setup is available. Contact your network administrator for assistance.</p>	<p>Make sure other devices on the network are turned on and do the following:</p> <ul style="list-style-type: none"> • If your product's Obtain IP Address setting is set to Manual, check the IP address, subnet mask, and default gateway addresses on the network connection report to see if they are correct. If not, correct the settings. • If DHCP is enabled, set your product's Obtain IP Address setting to Auto. If you want to use the DHCP-assigned address as a static address, set the Obtain IP Address setting to Manual, enter the product's IP address as listed on the network connection report, and set the subnet mask to 255.255.255.0. <p>If you still cannot connect to your product, turn off your router or access point, wait about 10 seconds, and turn it on again.</p>
<p>E-11 Setup is incomplete. Confirm default gateway setup. Connection using the EpsonNet Setup is available. Contact your network administrator for assistance.</p>	<p>If you set your product's TCP/IP Setup setting to Manual, check that the default gateway address listed on the network connection report is correct. Also turn on the device that is set as the default gateway.</p>

Error code and message	Solution
<p>E-12</p> <p>Confirm the following:</p> <ul style="list-style-type: none"> -Entered security key/password is correct -Index of the security key/password is set to the first number -IP address, subnet mask, or default gateway setup is correct <p>Contact your network administrator for assistance.</p>	<p>Make sure other devices on the network are turned on and do the following:</p> <ul style="list-style-type: none"> • Make sure the IP address, subnet mask, and default gateway addresses are correct, if you are entering them manually. • Confirm that the subnet mask and default gateway addresses for other devices are the same. • Make sure the IP address does not conflict with other devices. <p>If you still cannot connect to your product, do the following:</p> <ul style="list-style-type: none"> • Turn off your router or access point, wait about 10 seconds, and turn it on again. • Download and install your product software again to reset your network settings. • If your router or access point uses WEP security with several registered passwords, make sure that the first registered password is set on your product.
<p>E-13</p> <p>Confirm the following:</p> <ul style="list-style-type: none"> -Entered security key/password is correct -Index of the security key/password is set to the first number -Connection and network setup of the PC or other device is correct <p>Contact your network administrator for assistance.</p>	<p>Make sure your router, access point, and/or hub are turned on. Also make sure the TCP/IP setup on your router, access point, and/or hub is not set manually; this may cause your product's network settings to differ from the manually set up devices.</p> <p>If you still cannot connect to your product, do the following:</p> <ul style="list-style-type: none"> • Turn off your router or access point, wait about 10 seconds, and turn it on again. • Download and install your product software again to reset your network settings. • If your router or access point uses WEP security with several registered passwords, make sure that the first registered password is set on your product.

Network Environment Messages

Message	Solution
The Wi-Fi environment needs to be improved. Turn the wireless router off and then turn it on. If the connection does not improve, see the documentation for the wireless router.	Move your product closer to your router or access point, and remove any obstacles between them. Then turn off your router or access point, wait about 10 seconds, and turn it back on again. If you still cannot connect to your product, check the documentation that came with your router or access point for solutions.
*No more devices can be connected. Disconnect one of the connected devices if you want to add another one.	You can connect up to 8 computers or other devices to your product using a Wi-Fi Direct (Simple AP) connection. If you want to add another device, disconnect an existing connected device first.
The same SSID as Wi-Fi Direct exists in the environment. Change the Wi-Fi Direct SSID if you cannot connect a smart device to the printer.	Change the Wi-Fi Direct SSID.

Parent topic: [Printing a Network Connection Report](#)

Configuring Email Server Settings

To use features such as scanning to email or forwarding faxes to email, you need to configure the email server. You can select settings for the email server using the control panel on the product.

1. Press the  home button, if necessary.
2. Select **Settings**.
3. Select **General Settings**.

You see a screen like this:



4. Select **Network Settings**.
5. Scroll down and select **Advanced**.
6. Select **Email Server**.
7. Select **Server Settings**.

You see a screen like this:



8. Select one of the options shown above, then select the settings you want to use. Contact your internet service provider if necessary to confirm the authentication method for the email server.

9. Select **Proceed** to save your settings.
10. Select **Close** to exit.
11. Select **Connection Check** to verify the connection to the email server.

[Email Server Settings](#)

Parent topic: [Wi-Fi or Wired Networking](#)

Related tasks

[Scanning to Email](#)

Email Server Settings

Setting name	Available options	Description
Authentication Method	Off SMTP AUTH POP before SMTP	Selects the authentication method for the printer to access the mail server. SMTP AUTH: Authenticates on the SMTP server (outgoing mail server) when sending the email. The mail server needs to support SMTP authentication. POP before SMTP Authenticates on the POP3 server (receiving mail server) before sending the email. When you select this item, set the POP3 server.
Authenticated Account	—	Lets you enter a user name or email address for the mail server. Used with the POP before SMTP and SMTP AUTH methods.
Authenticated Password	—	Lets you enter a password for the authenticated account. Used with the POP before SMTP and SMTP AUTH methods.
Sender's Email Address	—	Lets you enter the email address to be displayed to the sender
SMTP Server Address	—	Lets you enter the address of the SMTP server
SMTP Server Port Number	—	Lets you enter the port number of the SMTP server. The default port is 25.

Setting name	Available options	Description
Secure Connection	None STARTTLS SSL/TLS	Selects the encryption protocol used by the email server. Used with the SMTP AUTH or Off authentication methods.
Certificate Validation	Enable Disable	Determines whether the CA Certificate is validated. You must import a CA certificate to use this setting.
POP3 Server Address	—	Lets you enter the address of the POP3 server using IPv4 or FQDN format.
POP3 Server Port Number	—	Lets you enter the port number of the POP3 server. The default port is 25.

Parent topic: [Configuring Email Server Settings](#)

Changing or Updating Network Connections

See these sections to change or update how your product connects to a network.

[Accessing the Web Config Utility](#)

[Changing a USB Connection to a Wi-Fi Connection](#)

[Changing a Wi-Fi Connection to a Wired Network Connection](#)

[Connecting to a New Wi-Fi Router](#)

[Disabling Wi-Fi Features](#)

Parent topic: [Wi-Fi or Wired Networking](#)

Accessing the Web Config Utility

You can select your product's network settings and confirm its operating status using a web browser. You do this by accessing your product's built-in Web Config utility from a computer or other device that is connected to the same network as your product.

Note: You can also access the Web Config utility from the product information area in the Epson Smart Panel app.

1. Print a network status sheet.
2. Locate the IP address for your product that is listed on the network status sheet.

3. On a computer or other device connected to the same network as your product, open a web browser.
4. Enter your product's IP address into the address bar.
5. On the first visit to the Web Config utility, you will be prompted to set an administrator password. The administrator password is required to access the full capabilities of the Web Config utility.

You see the available Web Config utility options.

Parent topic: [Changing or Updating Network Connections](#)

Related tasks

[Printing a Network Status Sheet](#)

Changing a USB Connection to a Wi-Fi Connection

If you have already connected your product to your computer using a USB connection, you can change to a Wi-Fi connection.

1. Disconnect the USB cable from your product.
2. Uninstall your product software.
3. Download and install your product software from the Epson website using the instructions on the *Start Here* sheet.

Parent topic: [Changing or Updating Network Connections](#)

Changing a Wi-Fi Connection to a Wired Network Connection

If you have already connected your product to your computer wirelessly, you can change to a wired network connection if necessary.

1. Disable your product's Wi-Fi features.
2. Connect one end of an Ethernet network cable to the product's **LAN** port.
3. Connect the other end to any available LAN port on your router or access point.
4. Uninstall your product software.
5. Download and install your product software from the Epson website.
6. Follow the on-screen instructions to install the software.
7. When you see the Select Your Connection screen, select **Wired network connection**.
8. If you see a Select Setup Option screen, select **Set up printer for the first time**.
9. Continue following the rest of the on-screen instructions.

Parent topic: [Changing or Updating Network Connections](#)

Related tasks

[Disabling Wi-Fi Features](#)

Connecting to a New Wi-Fi Router

If you change the wireless router you have been using on your network, you need to update your product's Wi-Fi connection to the new router.

Note: If your router uses a single network name (SSID) for both the 2.4 GHz and 5 GHz band, give each band its own network name (SSID) instead, such as Home Network 2.4 GHz and Home Network 5 GHz. See your router documentation for instructions.



1. Do one of the following:
 - **Windows:** Uninstall your product software.
 - **Mac:** Go to the next step.
2. Download and install your product software from the Epson website using the instructions on the *Start Here* sheet.

Parent topic: [Changing or Updating Network Connections](#)

Disabling Wi-Fi Features

You may need to disable your product's Wi-Fi features if you change your network connection type or need to solve a problem with your network connection.

Note: Before disabling Wi-Fi features, make a note of your product's SSID (network name) and password, and any network settings selected for the Epson Connect services you may use.

1. Press the  home button, if necessary.
2. Press the   icon.

You see a screen like this:

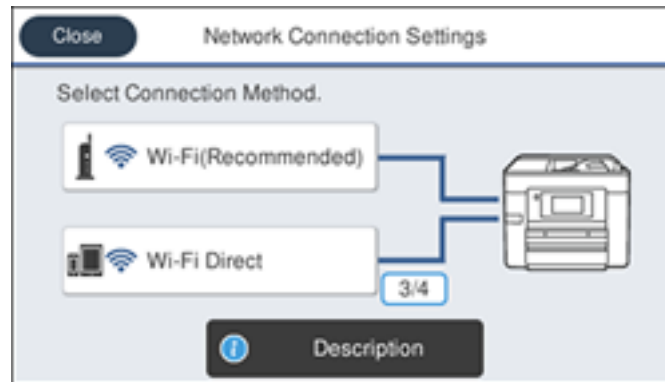

3. Select **Wi-Fi (Recommended)**.
4. Select **Change Settings**.
5. Select **Others**.
6. Select **Disable Wi-Fi**.
7. Select **Yes** to disable Wi-Fi.

Parent topic: [Changing or Updating Network Connections](#)

Loading Paper

Before you print, load paper for the type of printing you will do.

[Loading Paper in the Cassette](#)

[Compatible Epson Papers](#)

[Paper or Media Type Settings - Printing Software](#)

[Selecting the Paper Settings for Each Source - Control Panel](#)

[Selecting the Default Paper Source Settings](#)

[Selecting the Universal Print Settings](#)

Loading Paper in the Cassette

You can load paper up to this size in the paper cassette: Legal (8.5 × 14 inches [216 × 356 mm]).

Note: Before loading paper, make sure your product is not currently printing, scanning, or copying.

1. Press the  help button.

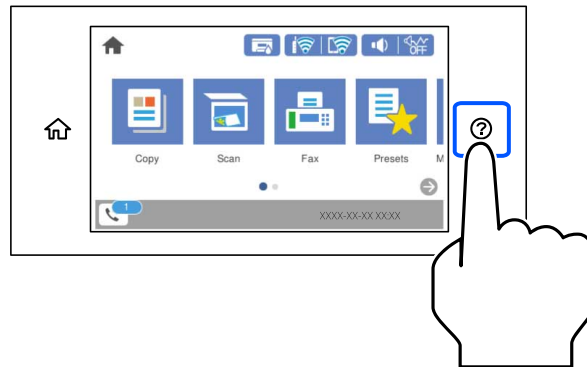

2. Select **How To**.
3. Select **Load Paper**.
4. Do one of the following:
 - To load Letter-sized paper, select **Basic**.

- To load Letter-sized paper in Cassette 1, select **In Cassette 1**.
- To load Letter-sized paper in Cassette 2, select **In Cassette 2**.
- To load paper that is larger than Letter size, select **Paper that exceeds the cassette length**
- To load envelopes, select **Load Envelope**.
- To load photo paper, select **Load Photo Paper**.

Always follow these paper loading guidelines:

- Do not remove or insert the paper cassette during printing.
- Load only the recommended number of sheets.
- Load paper short edge first and printable side facedown.
- Make sure the paper is under the tabs on the edge guides and not sticking out from the rear end of the cassette.
- If you have trouble loading a stack of envelopes, press each envelope flat before loading it or load one envelope at a time.
- If print quality declines when printing multiple envelopes, try loading one envelope at a time.
- Load letterhead or pre-printed paper top edge first.
- Check the paper package for any additional loading instructions.
- Load a single sheet of loose-leaf or other paper with holes as shown.

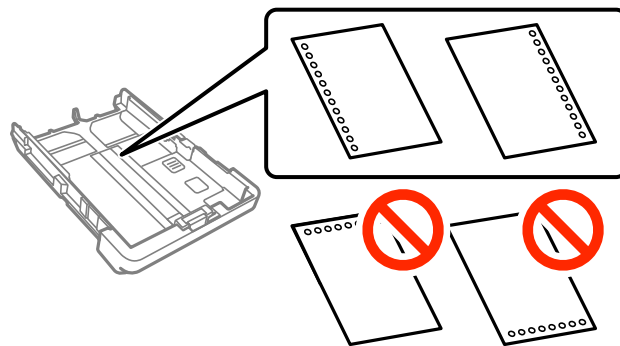

Note: Do not select automatic 2-sided printing for this type of paper and do not print over the holes. Select **Letterhead** or **Preprinted** as the paper type setting.

- When loading paper longer than the cassette, select **User-Defined** as the paper size setting. Make sure the end of the paper is cut perpendicularly and do not touch paper that is being fed or ejected.

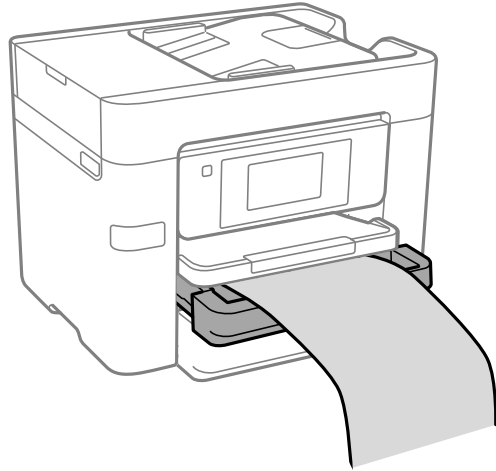

Note: When printing on glossy photo papers, ink drying times increase considerably (humidity, temperature, and other environmental conditions can also affect photo drying times). To avoid smearing your photos, do not touch the printed side until the ink is completely dry. Moisture and oils from your skin can also affect print quality, so avoid rubbing or scratching the surface of your photos even after they dry.

[Paper Loading Capacity](#)

[Double-sided Printing Capacity](#)

[Borderless Paper Type Compatibility](#)

Parent topic: [Loading Paper](#)

Related references

[Paper Specifications](#)

Paper Loading Capacity

See the table here for the loading capacity of the paper cassettes.

Paper type	Loading capacity	
	Cassette 1 (upper cassette)	Cassette 2 (lower cassette)
Plain paper Copy paper High-quality plain paper Letterhead paper Recycled paper Colored paper Pre-printed paper	Letter (8.5 × 11 inches [216 × 279 mm]) or A4 (8.3 × 11.7 inches [210 × 297 mm]), Legal (8.5 × 14 inches [216 × 356 mm]), Oficio 9 (8.46 × 12.4 inches [215 × 315 mm]), Mexico-Oficio (8.5 × 13.4 inches [216 × 340 mm]), or Executive (7.25 × 10.5 inches [184 × 267 mm]) size: Up to the line indicated by the triangle mark (250 sheets)	
	Half Letter (5.5 × 8.5 inches [140 × 216 mm]), A6 (4.1 × 5.8 inches [105 × 148 mm]), size: Up to the line indicated by the triangle mark (250 sheets)	—
	User defined paper size from 8.5 × 11 inches (216 × 297 mm) to 8.5 × 14 inches (216 × 356 mm) ¹ : 250 sheets	250 sheets
	User defined paper size from 3.5 × 5 inches (89 × 127 mm) to 8.5 × 11 inches (216 × 297 mm) ¹ : 250 sheets	—
	User defined paper size from 3.5 × 14 inches (89 × 356 mm) to 8.5 × 47.2 inches (216 × 1200 mm) ¹ : 1 sheet	—
Plain paper Copy paper High-quality plain paper Letterhead paper Recycled paper Colored paper Pre-printed paper	—	User defined paper size (7.2 × 10.1 inches (182 × 257 mm) to 8.5 × 14 inches (216 × 356 mm)) ² : 250 sheets
	—	User defined paper size from 7.2 × 14 inches (182 × 356 mm) to 8.5 × 47.2 inches (216 × 1200 mm) long ² : 1 sheet

Paper type	Loading capacity	
	Cassette 1 (upper cassette)	Cassette 2 (lower cassette)
Epson Bright White Premium Paper Epson Bright White Pro Paper Epson Multipurpose Plus Paper	250 sheets	
Epson Presentation Paper Matte	100 sheets	—
Epson Premium Presentation Paper Matte Epson Premium Presentation Paper Matte Double-sided Epson Brochure & Flyer Paper Matte Double-sided Epson Photo Paper Glossy ³ Epson Premium Photo Paper Glossy ³ Epson Ultra Premium Photo Paper Glossy ³ Epson Premium Photo Paper Semi-gloss ³	50 sheets	—

Paper type	Loading capacity	
	Cassette 1 (upper cassette)	Cassette 2 (lower cassette)
Card Stock	Letter (8.5 × 11 inches [216 × 279 mm]) or A4 (8.3 × 11.7 inches [210 × 297 mm]), Legal (8.5 × 14 inches [216 × 356 mm]), Oficio 9 (8.46 × 12.4 inches [215 × 315 mm]), Mexico-Oficio (8.5 × 13.4 inches [216 × 340 mm]), Executive (7.25 × 10.5 inches [184 × 267 mm]), Half Letter (5.5 × 8.5 inches [140 × 216 mm]), or A6 (4.1 × 5.8 inches [105 × 148 mm]) size: 50 sheets	—
	User defined paper size from 8.5 × 11 inches (216 × 297 mm) to 8.5 × 14 inches (216 × 356 mm) ¹ : 50 sheets	—
	User defined paper size from 3.5 × 5 inches (89 × 127 mm) to 8.5 × 14 inches (216 × 297 mm) ¹ : 50 sheets	—
	User defined paper size from 3.5 × 14 inches (89 × 356 mm) to 8.5 × 47.2 inches (216 × 1200 mm) ¹ : 1 sheet	—
Envelopes	10 envelopes	—

¹ The minimum paper width for Cassette 1 is 3.5 inches (89 mm).

² The minimum paper width for Cassette 2 is 7.2 inches (182 mm).

³ If paper feeds incorrectly, or printing is uneven or smeared, load 1 sheet at a time.

Parent topic: [Loading Paper in the Cassette](#)

Double-sided Printing Capacity

Paper type	Size	Double-sided Printing Capacity	
		Auto	Manual
Plain paper Copier paper Letterhead paper Recycled paper	Letter (8.5 × 11 inches [216 × 279 mm]), A4 (8.3 × 11.7 inches [210 × 297 mm]), Executive (7.25 × 10.5 inches [184 × 267 mm])	Up to the arrow mark	30 sheets
Colored paper Pre-printed paper High quality plain paper	Legal (8.5 × 14 inches [216 × 356 mm]) 8.5 × 13 inches (216 × 330 mm) Oficio 9 (8.46 × 12.4 inches [215 × 315 mm]), Mexico-Oficio (8.5 × 13.4 inches [216 × 340 mm]) Half Letter (5.5 × 8.5 inches [140 × 216 mm]) A6 (4.1 × 5.8 inches [105 × 148 mm])	—	30 sheets ¹
	User defined paper size from 8.5 × 11 inches (216 × 297 mm) to 8.5 × 14 inches (216 × 356 mm)	250 sheets	30 sheets
	User defined paper size from 3.5 × 5 inches (89 × 127 mm) to 8.5 × 14 inches (216 × 297 mm)	—	Cassette 1: 30 sheets Cassette 2: —
	User defined paper size from 3.5 × 14 inches (89 × 356 mm) to 8.5 × 47.2 inches (216 × 1200 mm)	—	1 sheet ¹

Paper type	Size	Double-sided Printing Capacity	
		Auto	Manual
Epson Bright White Premium Paper Epson Bright White Pro Paper Epson Multipurpose Plus Paper	Letter (8.5 × 11 inches [216 × 279 mm])	250 sheets	30 sheets
Epson Premium Presentation Paper Matte Epson Premium Presentation Paper Matte Double-sided Epson Brochure & Flyer Paper Matte Double-sided Epson Photo Paper Glossy ¹ Epson Premium Photo Paper Glossy ¹ Epson Ultra Premium Photo Paper Glossy ¹ Epson Premium Photo Paper Semi-gloss ¹	Letter (8.5 × 11 inches [216 × 279 mm]) and smaller	—	—

Paper type	Size	Double-sided Printing Capacity	
		Auto	Manual
Card Stock ²	Letter (8.5 × 11 inches [216 × 279 mm]), A4 (8.3 × 11.7 inches [210 × 297 mm]), Executive (7.25 × 10.5 inches [184 × 267 mm])	50	10 sheets
	Legal (8.5 × 14 inches [216 × 356 mm])8.5 × 13 inches (216 × 330 mm)Oficio 9 (8.46 × 12.4 inches [215 × 315 mm]), Mexico-Oficio (8.5 × 13.4 inches [216 × 340 mm])Half Letter (5.5 × 8.5 inches [140 × 216 mm])A6 (4.1 × 5.8 inches [105 × 148 mm])	—	10 sheets
	User defined paper size from 8.5 × 11 inches (216 × 297 mm) to 8.5 × 14 inches (216 × 356 mm)	50 sheets	10 sheets
	User defined paper size from 3.5 × 5 inches (89 × 127 mm) to 8.5 × 14 inches (216 × 297 mm)	—	10 sheets
	User defined paper size from 3.5 × 14 inches (89 × 356 mm) to 8.5 × 47.2 inches (216 × 1200 mm)	—	1 sheet
Envelopes	No. 10 (4.1 × 9.5 inches [105 × 241 mm])	—	—

¹ The minimum paper width for Cassette 2 is 7.2 inches (182 mm).

² Card Stock can only be used in Cassette 1.

Parent topic: [Loading Paper in the Cassette](#)

Borderless Paper Type Compatibility

You can print borderless photos on compatible paper types in compatible sizes:

Borderless Paper Types

- Plain paper or Card Stock (Letter (8.5 × 11 inches [216 × 279 mm]) or A4 (8.3 × 11.7 inches [210 × 297 mm]) only)*
- Epson Bright White Premium Paper*
- Epson Bright White Pro Paper*
- Epson Multipurpose Plus Paper*
- Epson Photo Paper Glossy
- Epson Premium Photo Paper Glossy
- Epson Ultra Premium Photo Paper Glossy
- Epson Premium Photo Paper Semi-gloss
- Epson Presentation Paper Matte*
- Epson Premium Presentation Paper Matte
- Epson Premium Presentation Paper Matte Double-sided
- Epson Brochure & Flyer Paper Matte Double-sided

* These paper types may scuff the print head, resulting in smeared printouts.

Borderless Paper Sizes

- 4 × 6 inches (102 × 152 mm)
- 5 × 7 inches (127 × 178 mm)
- 16:9 wide (4 × 7.1 inches [102 × 181 mm])
- A4 (8.3 × 11.7 inches [210 × 297 mm])
- Letter (8.5 × 11 inches [216 × 279 mm])

Parent topic: [Loading Paper in the Cassette](#)

Compatible Epson Papers

You can purchase genuine Epson ink and paper at epson.com (U.S. sales) or epson.ca (Canadian sales). You can also purchase supplies from an Epson authorized reseller. To find the nearest one, call 800-GO-EPSON (800-463-7766) in the U.S. or 800-807-7766 in Canada.

Paper Type	Size	Part number	Sheet count
Epson Bright White Pro Paper	Letter (8.5 × 11 inches [216 × 279 mm])	S041586	500
Epson Bright White Premium Paper	Letter (8.5 × 11 inches [216 × 279 mm])	S450218-4	500
Epson Multipurpose Plus Paper	Letter (8.5 × 11 inches [216 × 279 mm])	S450217-4	500
Epson Presentation Paper Matte	Letter (8.5 × 11 inches [216 × 279 mm])	S041062	100
	Legal (8.5 × 14 inches [216 × 356 mm])	S041067	100
Epson Premium Presentation Paper Matte	8 × 10 inches (203 × 254 mm)	S041467	50
	Letter (8.5 × 11 inches [216 × 279 mm])	S041257 S042180	50 100
Epson Premium Presentation Paper Matte Double-sided	Letter (8.5 × 11 inches [216 × 279 mm])	S041568	50
Epson Brochure & Flyer Paper Matte Double-sided	Letter (8.5 × 11 inches [216 × 279 mm])	S042384	150
Epson Photo Paper Glossy	4 × 6 inches (102 × 152 mm)	S041809	50
		S042038	100
	Letter (8.5 × 11 inches [216 × 279 mm])	S041141 S041649 S041271	20 50 100

Paper Type	Size	Part number	Sheet count
Epson Premium Photo Paper Glossy	4 × 6 inches (102 × 152 mm)	S041808	40
		S041727	100
	16:9 wide (4 × 7.1 inches [102 × 181 mm])	S042109	20
	5 × 7 inches (127 × 178 mm)	S041464	20
	8 × 10 inches (203 × 254 mm)	S041465	20
Epson Ultra Premium Photo Paper Glossy	Letter (8.5 × 11 inches [216 × 279 mm])	S042183	25
		S041667	50
	4 × 6 inches (102 × 152 mm)	S042181	60
		S042174	100
Epson Premium Photo Paper Semi-gloss	5 × 7 inches (127 × 178 mm)	S041945	20
	8 × 10 inches (203 × 254 mm)	S041946	20
	Letter (8.5 × 11 inches [216 × 279 mm])	S042182	25
	S042175	50	
Epson Premium Photo Paper Semi-gloss	4 × 6 inches (102 × 152 mm)	S041982	40
	Letter (8.5 × 11 inches [216 × 279 mm])	S041331	20

Parent topic: [Loading Paper](#)

Paper or Media Type Settings - Printing Software

For this paper	Select this paper Type or Media Type setting
Plain paper Epson Bright White Pro Paper	Plain Paper / Bright White Paper
Letterhead paper	Letterhead
Recycled paper	Recycled
Colored paper	Color

For this paper	Select this paper Type or Media Type setting
Pre-printed paper	Preprinted
High-quality plain paper Epson Bright White Premium Paper Epson Multipurpose Plus Paper	High Quality Plain Paper
Thick paper	Card Stock
Envelopes	Envelope
Epson Ultra Premium Photo Paper Glossy	Ultra Premium Photo Paper Glossy
Epson Premium Photo Paper Glossy	Premium Photo Paper Glossy
Epson Photo Paper Glossy	Photo Paper Glossy
Epson Premium Photo Paper Semi-gloss	Premium Photo Paper Semi-Gloss
Epson Premium Presentation Paper Matte Epson Premium Presentation Paper Matte Double-sided Epson Brochure & Flyer Paper Matte Double-sided	Premium Presentation Paper Matte
Epson Presentation Paper Matte	Presentation Paper Matte

Note: The settings listed here are available only when printing from your computer; they do not apply to your product's control panel settings.

Parent topic: [Loading Paper](#)

Selecting the Paper Settings for Each Source - Control Panel

You can change the default paper size and paper type for each source using the control panel on the product.

1. Press the  home button, if necessary.
2. Select **Settings > General Settings > Printer Settings > Paper Source Settings > Paper Setting**.
3. If necessary, select the paper source you want to change.
4. Select **Paper Size**.
5. Select the paper size you loaded.

6. Select **Paper Type**.
7. Select the paper type you loaded.
8. Select **Favorite Paper Settings** to choose from a list of commonly used paper settings.
9. Select  to choose another paper source or exit.

[Paper Type Settings - Control Panel](#)

Parent topic: [Loading Paper](#)

Paper Type Settings - Control Panel

Select a **Paper Type** setting that matches the paper you loaded.

Paper type loaded	Paper Type setting
Plain paper Epson Bright White Pro Paper	Plain Paper
Letterhead paper	Letterhead
Recycled paper	Recycled
Colored paper	Color
Pre-printed paper	Preprinted
High-quality plain paper Epson Bright White Premium Paper Epson Multipurpose Plus Paper	High Quality Plain Paper
Envelopes	Envelope
Thick paper	Card Stock
Epson Ultra Premium Photo Paper Glossy	Ultra Glossy
Epson Premium Photo Paper Glossy	Prem. Glossy
Epson Photo Paper Glossy	Glossy
Epson Premium Photo Paper Semi-gloss	Prem. Semi-Gloss

Paper type loaded	Paper Type setting
Epson Premium Presentation Paper Matte Epson Premium Presentation Paper Matte Double-sided Epson Brochure & Flyer Paper Matte Double-sided	Prem. Matte
Epson Presentation Paper Matte	Presentation Matte

Parent topic: [Selecting the Paper Settings for Each Source - Control Panel](#)

Selecting the Default Paper Source Settings

You can change default paper source settings using the control panel on the product.

1. Press the  home button, if necessary.
2. Select **Settings** > **General Settings** > **Printer Settings**.

You see a screen like this:



3. Select one of these **Auto Error Solver** options:
 - Turn on this setting to display a warning and print single-sided when a 2-sided printing error occurs, or to print only what the printer could process when a memory full error occurs.
 - Turn off this setting to display an error message and stop printing if an error occurs.
4. Select the **Paper Source Settings** options you want to use.

5. When you are finished, press the  home button to exit.

[Paper Source Settings Options](#)

Parent topic: [Loading Paper](#)

Paper Source Settings Options

Select the paper source options you want to use for your print jobs.

Paper Source Settings option	Available settings	Description
Paper Setting	Various	Select the paper size and type for each paper source
A4/Letter Auto Switching	On	Select On to switch the selected paper size to match the loaded paper (Letter or A4) if the wrong size is selected
	Off	
Auto Select Settings	Copy	Select On for any of these settings to automatically print on paper from any source containing paper that matches your paper settings
	Fax	
	Other	
Error Notice	Paper Size Notice	Select On for either of these settings to display an error message when the selected paper type or size does not match the loaded paper
	Paper Type Notice	
Paper Setup Auto Display	On	Select On to automatically display a menu that lets you select the paper size and type when you load paper in the product Note: If this setting is disabled, you cannot print over AirPrint.
	Off	

Parent topic: [Selecting the Default Paper Source Settings](#)

Selecting the Universal Print Settings

You can change the default universal print settings using the control panel on the product.

1. Press the , if necessary.
2. Select **Settings** > **General Settings** > **Printer Settings** > **Universal Print Settings**.

You see this screen:



3. Adjust the settings as necessary.
4. When you are finished, press the  home button to exit.

[Universal Print Settings Options](#)

Parent topic: [Loading Paper](#)

Universal Print Settings Options

Select the universal print setting options you want to use for your print jobs.

Universal Print Settings option	Available settings	Description
Top Offset	—	Adjust the top or left margin
Left Offset		
Top Offset in Back	—	Adjust the top or left margin of the back page when printing double-sided.
Left Offset in Back		
Check Paper Width	On	Select On to check the paper width before printing. This prevents printing beyond the edges of the paper when the paper size settings are incorrect, but may reduce the printing speed.
	Off	

Universal Print Settings option	Available settings	Description
Skip Blank Page	On	Select On to skip printing of blank pages automatically
	Off	

Parent topic: [Selecting the Universal Print Settings](#)

Placing Originals on the Product

Follow the instructions here to place your original documents or photos on the product.

Caution: Do not place anything on top of your product or use its cover as a writing surface to avoid damaging it.

[Placing Originals on the Scanner Glass](#)

[Placing Originals in the Automatic Document Feeder](#)

Placing Originals on the Scanner Glass

You can place originals up to this size on the scanner glass: Letter (8.5 × 11 inches [216 × 279 mm]) or A4 (8.3 × 11.7 inches [210 × 297 mm]).

Note: To view animated instructions on how to place originals on the scanner glass, press the  help button and select **How To > Place Originals > Scanner Glass**.

Note: When originals are placed in the ADF and on the scanner glass, priority is given to the originals in the ADF.

1. Open the document cover.

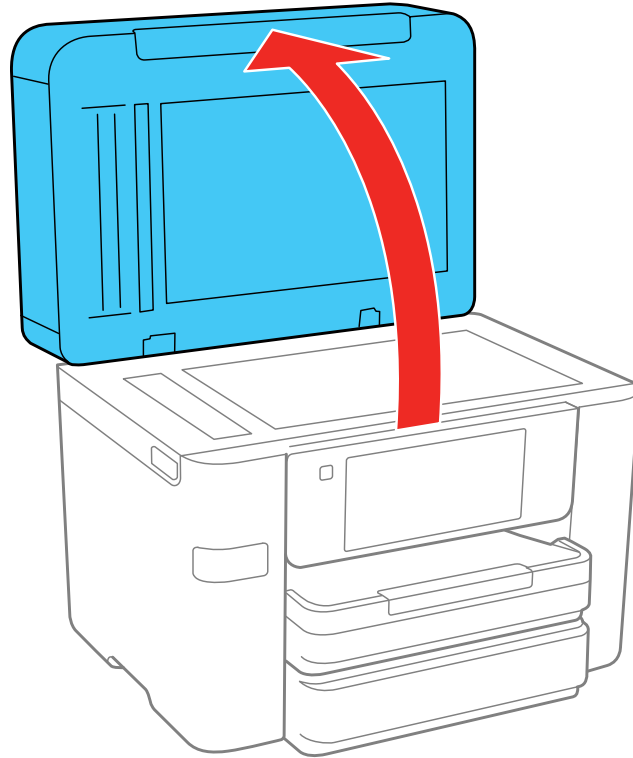

2. Place your original facedown on the scanner glass with the top facing into the corner. Slide the original to the edges of the indicated corner.

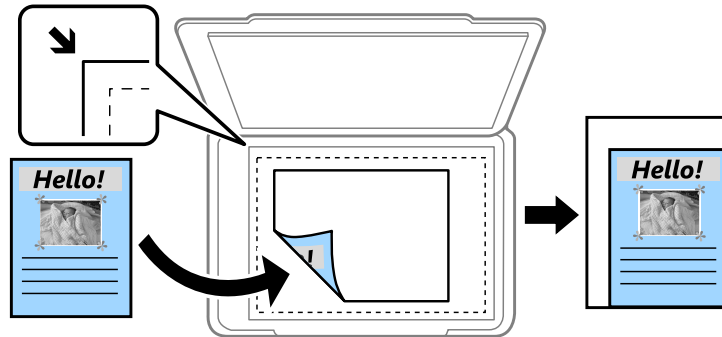

Note: The edges of your original may be cropped by 0.06 inch (1.5 mm) from the edge of the scanner glass. Manually position your original away from the edges to prevent cropping.

3. Close the document cover gently to keep your original in place.

Caution: Do not push down on the document cover or scanner glass or you may damage the product.

Remove your originals after scanning. If you leave the originals on the scanner glass for a long time, they may stick to the glass surface.

Parent topic: [Placing Originals on the Product](#)

Related topics

[Copying](#)

[Scanning](#)

[Faxing](#)

Placing Originals in the Automatic Document Feeder

You can place single- or multi-page original documents in the Automatic Document Feeder (ADF). You can also use the ADF to scan both sides of a 2-sided document. Make sure the originals meet the Automatic Document Feeder specifications before loading them.

Caution: Make sure your originals are not creased or folded, and do not contain holes, staples, tape, or other materials that could obstruct the feeder.

Caution: Do not place photographs or valuable artwork in the ADF. Place fragile or valuable originals on the scanner glass to avoid wrinkling or damaging them.

Note: To view animated instructions on how to place originals in the ADF, press the  help button and select **How To > Place Originals > ADF**.

Note: When originals are placed in the ADF and on the scanner glass, priority is given to the originals in the ADF.

1. Open the ADF document support.

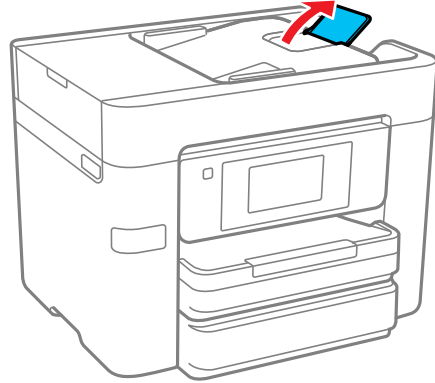

2. Slide the ADF edge guide outward.

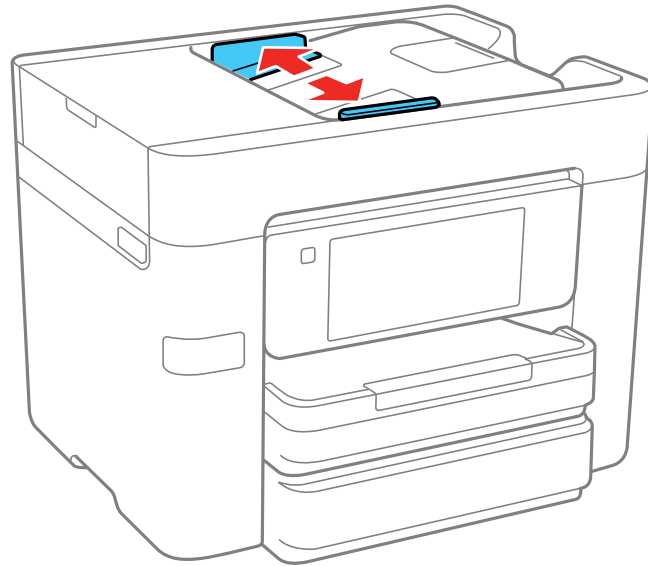

3. Fan your stack of originals and tap them gently on a flat surface to even the edges.

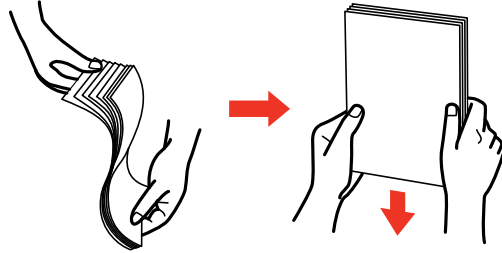

4. Insert the originals into the ADF faceup and short edge first.

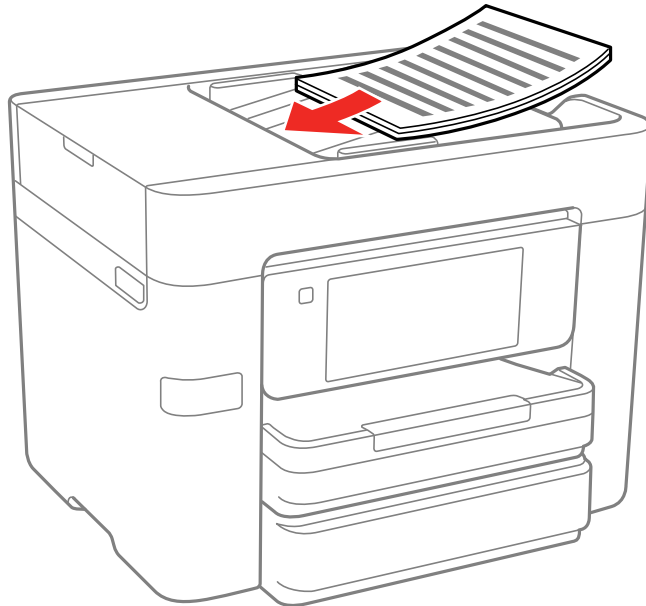

Note: Do not load originals above the arrow mark on the ADF edge guide.

The **ADF** icon on the Copy, Scan, and Fax screens lights up.

5. Slide the ADF edge guides against the originals, but not too tightly.

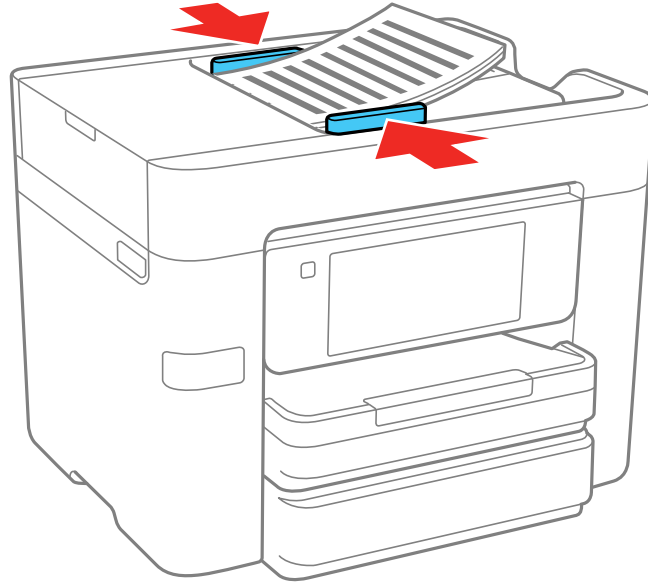

[ADF Original Document Specifications](#)

Parent topic: [Placing Originals on the Product](#)

Related topics

[Copying](#)

[Scanning](#)

[Faxing](#)

ADF Original Document Specifications

You can load original documents that meet these specifications in the ADF.

Paper type	Paper size	Paper weight	Loading capacity
Plain paper	Letter (8.5 × 11 inches [216 × 279 mm])	17 to 24 lb (64 to 90 g/m ²)	Approximately 50 sheets
	A4 (8.3 × 11.7 inches [210 × 297 mm])		
	Executive (7.25 × 10.5 inches [184 × 267 mm])		
	Half Letter (5.5 × 8.5 inches [140 × 216 mm])		
	Legal (8.5 × 14 inches [216 × 356 mm])		
	8.5 × 13 inches (216 × 330 mm)		Approximately 10 sheets

Caution: Do not load the following types of originals in the ADF, or they may be damaged or may damage the scanner. Use the scanner glass for these types:

- Ripped, curled, folded, deteriorated, or wrinkled originals
- Photos or valuable original artwork
- Originals with binding holes
- Originals containing staples or paper clips
- Originals with labels, stickers, or sticky notes
- Thermal paper
- Originals with carbon paper backing
- Originals that are bound
- Transparencies
- Irregularly-cut or angled originals

Parent topic: [Placing Originals in the Automatic Document Feeder](#)

Copying

See the information here to copy documents or photos using your product.

Note: Copies may not be exactly the same size as your originals.

[Copying Documents or Photos](#)

[Copying Options](#)

Copying Documents or Photos

You can copy documents or photos onto various sizes and types of paper, including Epson special papers.

1. Place your original document or photo on the scanner glass, or place multi-page documents in the ADF.
2. Load the paper you want to print on.
3. Press the  home button, if necessary.
4. Select **Copy**.

You see a screen like this:

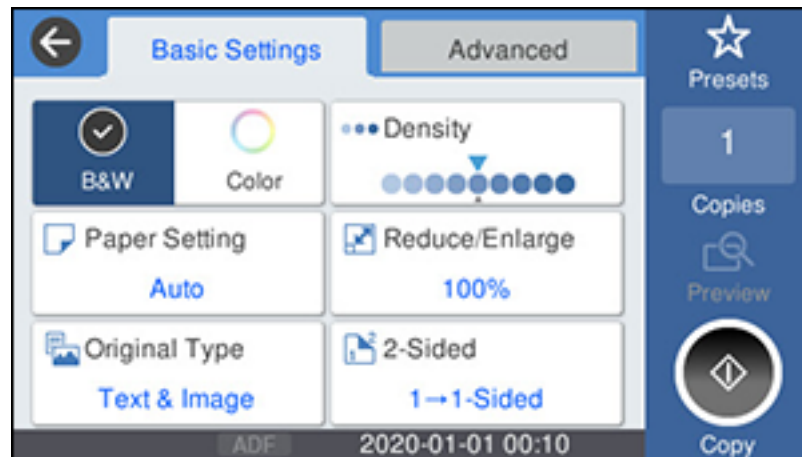

5. To print more than one copy, press a number key on the product's control panel, or select **Copies** and use the displayed keypad to enter the number of copies.
6. Change any of the displayed settings as necessary.
7. Select **Advanced** to view and change additional copy settings, if necessary.
8. Select **Preview** to preview your copy on the LCD screen.
9. Select **Preset** to save your copy settings.
10. When you are ready to copy, press the **Copy** icon.

Note: To cancel printing, select **Cancel**.

Parent topic: [Copying](#)

Related references

[Copying Options](#)

[Compatible Epson Papers](#)

Related tasks

[Using Presets](#)

[Loading Paper in the Cassette](#)

Related topics

[Placing Originals on the Product](#)

Copying Options

Select the copying options you want to use for your copies.

Note: Not all options or settings may be available, depending on other copying settings.

Basic Settings

Copying option	Available settings	Description
B&W	—	Copies the document in black and white
Color	—	Copies the document in color
Paper Setting	Various sources	Select the paper source that you want to use. If you select Auto , paper is fed automatically depending on the paper settings you selected for the paper sources.

Copying option	Available settings	Description
Original Type	Text	Specifies the document type of your originals and adjusts the quality of your copies
	Text & Image	
	Photo	
	Text & Image(Best)	
Density	Varying levels	Adjusts the lightness or darkness of copies
Reduce/Enlarge	100%	Select the value and enter a value between 25% and 400% to reduce or enlarge the original. For example, 25% would create a copy one-quarter of the size, while 400% creates a copy four times larger.
	Auto	Automatically sizes the image to fit the paper size you selected
	Actual Size	Copies the original at its full size
	Reduce to Fit Paper	Copies the original at a smaller size than the Reduce/Enlarge value to fit within the paper size.
	Various conversion options	Automatically converts from one size to another
2-Sided	1>1-Sided	Select to make 2-sided copies. When you select 1>2-Sided or 2>1-Sided , also select the Advanced tab to select the orientation and binding edge for your originals or copies.
	2>2-Sided	
	1>2-Sided	
	2>1-Sided	

Advanced settings

Copying option	Available settings	Description
Multi-Page	Single Page	Copies each page of the original onto an individual sheet
	2-up	Copies multiple page documents onto one sheet. Scroll down and select the document orientation and layout order settings as necessary.
	4-up	
Original Size	Various sizes	Select the document size of your original

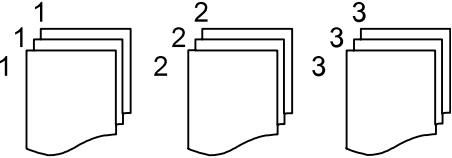
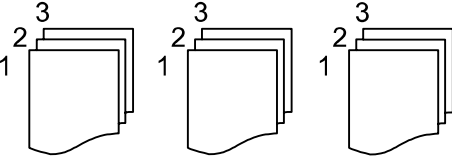
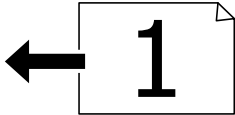
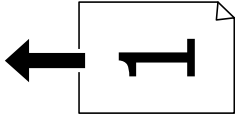
Copying option	Available settings	Description
Finishing	Group (Same Pages)	Select to print multiple copies of a multi-page document in unordered groups 
	Collate (Page Order)	Select to print multiple copies of a multi-page document in ordered sets 
Orientation (Original)	Readable Direction	Specifies the orientation of your originals
	Left Direction	Readable Direction:  Left Direction: 

Copying option	Available settings	Description
Image Quality	Contrast :	Adjusts the difference between the light and dark sections of the original:
	Saturation	Adjusts the vividness of the colors
	Red Balance Green Balance Blue Balance	Adjusts the density of each color
	Sharpness	Adjusts the outline of the image
	Hue Regulation	Adjusts the color tone of skin. Select + to increase the green hue (cool), or - to increase the red hue (warm).
	Remove Background	Adjusts the density of the background color. Select + to make the background lighter, or - to make the background darker.
	Binding Margin	Off
On		
Reduce to Fit Paper	Off	Copies the original at a smaller size than the Reduce/Enlarge value to fit within the paper size.
	On	
Remove Shadow	Off	Select On to erase the shadows that appear in the center of a document when copying a book or that appear around a document when copying thick paper
	On	
Remove Punch Holes	Off	Select On to erase the binding holes on a document
	On	
ID Card Copy	Off	Select On to copy both sides of an ID card onto one side of a sheet of paper
	On	

Parent topic: [Copying](#)

Printing from a Computer

Before printing from your computer, make sure you have set up your product and installed its software as described on the *Start Here* sheet.

Note: If you have an Internet connection, it is a good idea to check for updates to your product software on Epson's support website. If you see a Software Update screen, select **Enable automatic checking** and click **OK**. The update scans your system to see if you have the latest product software. Follow the on-screen instructions.

[Printing with Windows](#)

[Printing with the Built-in Epson Driver - Windows 10 S](#)

[Printing on a Mac](#)

[Printing from a Smartphone or Tablet](#)

[Cancelling Printing Using the Product](#)

Printing with Windows

You can print with your product using any Windows application, as described in these sections.

Note: If you are using your Epson product with the Windows 10 S operating system, you cannot use the software described in this section. You also cannot download and install any Epson product software from the Epson website for use with Windows 10 S; you must obtain software only from the Windows Store.

[Selecting Basic Print Settings - Windows](#)

[Selecting Double-sided Printing Settings - Windows](#)

[Selecting Additional Layout and Print Options - Windows](#)

[Selecting a Printing Preset - Windows](#)

[Selecting Extended Settings - Windows](#)

[Printing Your Document - Windows](#)

[Locking Printer Settings - Windows](#)

[Selecting Default Print Settings - Windows](#)

[Changing Automatic Update Options](#)

Parent topic: [Printing from a Computer](#)

Selecting Basic Print Settings - Windows

Select the basic settings for the document or photo you want to print.

1. Open a photo or document for printing.
2. Select the print command in your application.

Note: You may need to select a print icon on your screen, the **Print** option in the File menu, or another command. See your application's help utility for details.

3. If necessary, select your product name as the printer you want to use.

Note: You may also need to select **Properties** or **Preferences** to view your print settings.

You see the Main tab of your printer settings window:

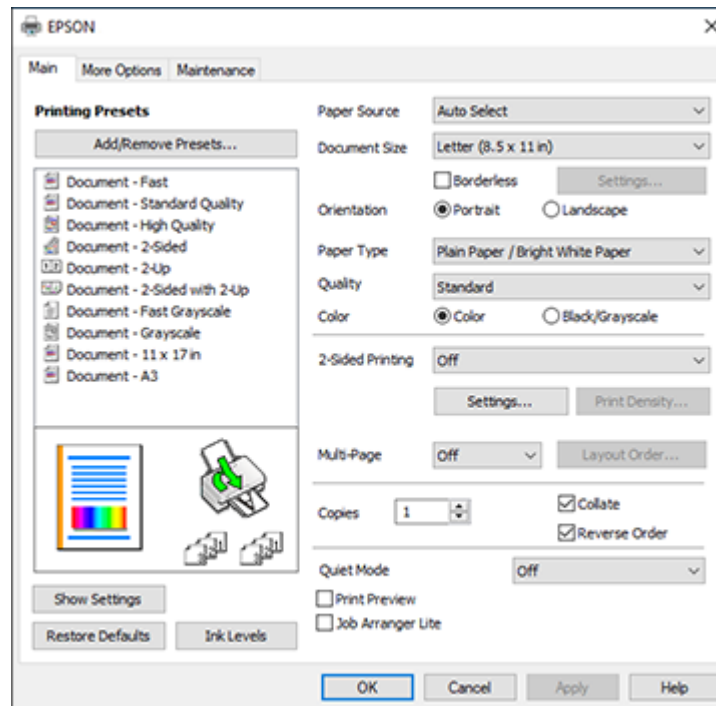

4. Select the size of the paper you loaded as the Document Size setting.

Note: You can also select the **User-Defined** setting to create a custom paper size.

5. If you are printing a borderless photo, select **Borderless**. You can click **Settings** to access additional options for borderless printing.

Note: You must select a compatible borderless paper type and size to print without borders. Check the borderless paper compatibility list for details.

6. Select the orientation of your document.

Note: If you are printing an envelope, select **Landscape**.

7. Select the type of paper you loaded as the Paper Type setting.

Note: The setting may not exactly match the name of your paper. Check the paper type settings list for details.

8. Select the **Quality** setting that matches the print quality you want to use.

9. Select a Color option:

- To print a color document or photo, select the **Color** setting.
- To print text and graphics in black or shades of gray, select the **Black/Grayscale** setting.

10. To print on both sides of the paper, select the **2-Sided Printing** setting and select the options you want.

11. To print multiple pages on one sheet of paper, or print one image on multiple sheets of paper, select one of the settings in the Multi-Page menu and select the printing options you want.

12. To print multiple copies and arrange their print order, select the **Copies** options.

13. To preview your job before printing, select **Print Preview**.

14. To save your print job as a project that can be modified and combined with other print jobs, select **Job Arranger Lite**.

15. To reduce noise during printing when you select **Plain Paper/Bright White Paper**, select **On** in the Quiet Mode menu.

Note: Enabling **Quiet Mode** may reduce printing speed.

[Paper Source Options - Windows](#)
[Print Quality Options - Windows](#)
[Multi-Page Printing Options - Windows](#)

Parent topic: [Printing with Windows](#)

Related references

[Borderless Paper Type Compatibility](#)

Related tasks

[Selecting Double-sided Printing Settings - Windows](#)

[Printing Your Document - Windows](#)

Paper Source Options - Windows

You can select any of the available options in the Paper Source menu to print on the paper loaded in that source.

Auto Select

Automatically selects the paper source based on the selected paper size.

Paper Cassette 1

Selects the paper in cassette 1 as the paper source.

Paper Cassette 2

Selects the paper in cassette 2 as the paper source.

Parent topic: [Selecting Basic Print Settings - Windows](#)

Print Quality Options - Windows

You can select any of the available Quality options to fine-tune the quality of your print. Some settings may be unavailable, depending on the paper type and border setting you have chosen.

Draft

For draft printing on plain paper.

Standard

For everyday text and image printing.

High

For photos and graphics with high print quality.

Parent topic: [Selecting Basic Print Settings - Windows](#)

Multi-Page Printing Options - Windows

You can select any of the available options in the Multi-Page menu to set up your multi-page print job.

2-Up, 4-Up, 6-Up, 8-Up, 9-Up, and 16-Up

Prints several pages on one sheet of paper. Click the **Layout Order** button to select page layout and border options.

2×1 Poster, 2×2 Poster, 3×3 Poster, 4×4 Poster

Prints one image on multiple sheets of paper to create a larger poster. Click the **Settings** button to select image layout and guideline options.

Parent topic: [Selecting Basic Print Settings - Windows](#)

Selecting Double-sided Printing Settings - Windows

You can print on both sides of the paper by selecting one of the 2-Sided Printing options on the Main tab.

Note: Some options may be pre-selected or unavailable, depending on other settings you have chosen or if you are accessing the product over a network.

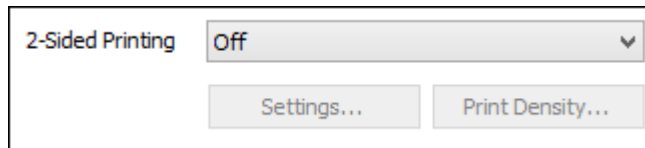

1. Select one of the following options for **2-Sided Printing**:
 - **Auto (Long-edge binding)** to print your double-sided print job by automatically flipping the paper on the long edge.
 - **Auto (Short-edge binding)** to print your double-sided print job by automatically flipping the paper on the short edge.
 - **Manual (Long-edge binding)** to print your double-sided print job by printing one side and prompting you to flip the paper over on the long edge to print the other side (recommended for paper types that do not support automatic duplexing).
 - **Manual (Short-edge binding)** to print your double-sided print job by printing one side and prompting you to flip the paper over on the short edge to print the other side (recommended for paper types that do not support automatic duplexing).
2. Click the **Settings** button.

You see this window:

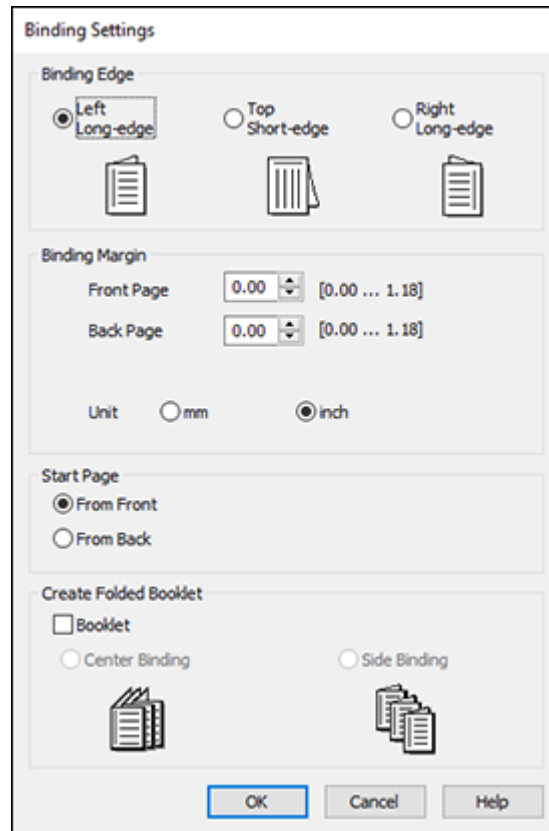

3. Select the double-sided printing options you want to use.
4. Click **OK** to return to the Main tab.
5. Click the **Print Density** button.

You see this window:

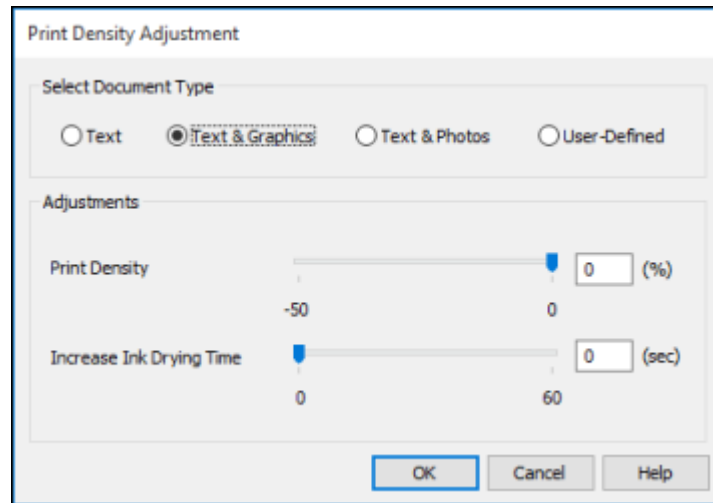

6. Select the type of document you are printing as the Document Type setting. The software automatically sets the Adjustments options for that document type.
7. If necessary, select the Adjustments options you want to use.
8. Click **OK** to return to the Main tab.
9. Print a test copy of your double-sided document to test the selected settings.
10. Follow any instructions displayed on the screen during printing.

[Double-sided Printing Options - Windows](#)

[Print Density Adjustments - Windows](#)

Parent topic: [Printing with Windows](#)

Double-sided Printing Options - Windows

You can select any of the available options on the Binding Settings window to set up your double-sided print job.

Binding Edge Options

Select a setting that orients double-sided print binding in the desired direction.

Binding Margin Options

Select options that define a wider margin to allow for binding.

Start Page

Selects whether printing starts on the front or back page.

Create Folded Booklet Options

Select the **Booklet** checkbox and a binding option to print double-sided pages as a booklet.

Parent topic: [Selecting Double-sided Printing Settings - Windows](#)

Related references

[Double-sided Printing Capacity](#)

Related tasks

[Selecting Basic Print Settings - Windows](#)

Print Density Adjustments - Windows

You can select any of the available options on the Print Density Adjustment window to adjust the print quality of your double-sided print job.

Print Density

Sets the level of ink coverage for double-sided printing.

Increase Ink Drying Time

Sets the amount of time required for drying ink after printing on one side of the paper before printing the other side in double-sided printing to prevent ink smearing.

Parent topic: [Selecting Double-sided Printing Settings - Windows](#)

Selecting Additional Layout and Print Options - Windows

You can select a variety of additional layout and printing options for your document or photo on the **More Options** tab.

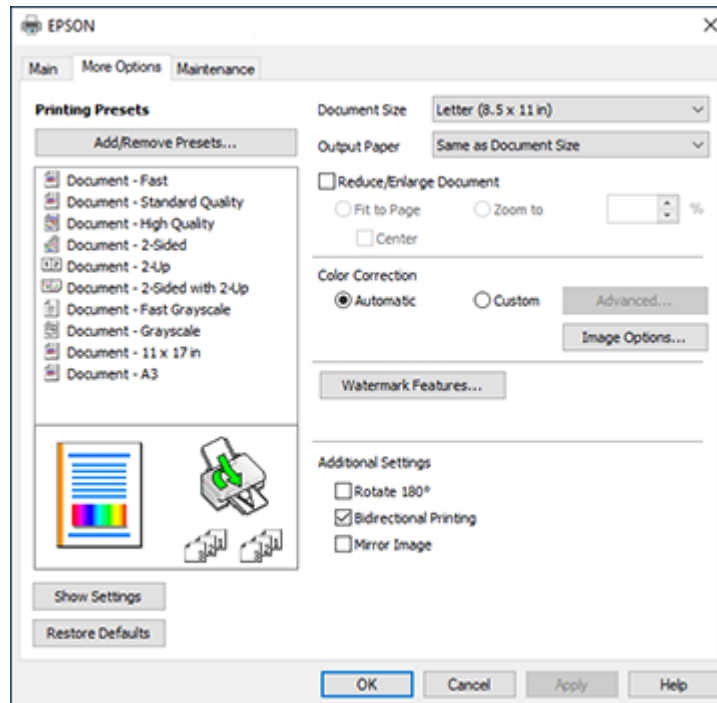

1. To change the size of your printed document or photo, select the **Reduce/Enlarge Document** checkbox and select one of these sizing options:
 - Select the **Fit to Page** option to size your image to fit the paper you loaded. Select the size of your document or photo as the Document Size setting, and the size of your paper as the Output Paper setting. If you want to center your image on the paper, select the **Center** option.
 - Select the **Zoom to** option to reduce or enlarge your document or photo by a specific percentage. Select the percentage in the % menu.
2. Select one of the following Color Correction options:
 - Select **Automatic** to automatically adjust the sharpness, brightness, contrast, and color saturation for your image.

- Select **Custom** and click the **Advanced** button to manually adjust the color correction settings or turn off color management in your printer software.
- Select **Image Options** to access additional settings for improving printed images.

Note: You can also select **Color Universal Print** settings.

3. To add the following features, click the **Watermark Features** button:

- **Anti-Copy Pattern:** adds a watermark that only appears when your printout is copied
- **Watermark:** adds a visible watermark to your printout

Note: Click the **Add/Delete** button to create your own watermark, and click the **Settings** button to customize the watermark.

- **Header/Footer:** adds information such as the date and time to the top or bottom of your printout

Note: Click the **Settings** button to customize the text and location of the header or footer.

4. Select any of the Additional Settings options to customize your print.

[Custom Color Correction Options - Windows](#)

[Image Options and Additional Settings - Windows](#)

[Header/Footer Settings - Windows](#)

Parent topic: [Printing with Windows](#)

Related tasks

[Printing Your Document - Windows](#)

Custom Color Correction Options - Windows

You can select any of the available options in the Color Correction window to customize the image colors for your print job.

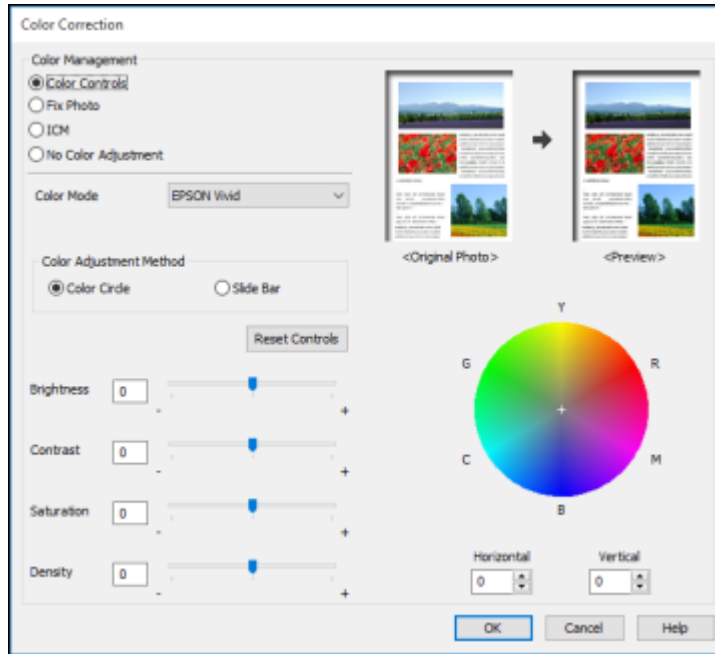

Color Controls

Lets you select a **Color Mode** setting, individual settings for **Brightness**, **Contrast**, **Saturation**, and **Density**, and individual color tones. Depending on the selected color mode, you can also adjust the midtone density using the **Gamma** setting.

Fix Photo

Improves the color, contrast, and sharpness of flawed photos.

Note: Fix Photo uses a sophisticated face recognition technology to optimize photos that include faces. For this to work, both eyes and the nose must be visible in the subject's face. If your photo includes a face with an intentional color cast, such as a statue, you may want to turn off **Fix Photo** to retain the special color effects.

ICM

Lets you manage color using installed color printing profiles.

No Color Adjustment

Turns off color management in your printer software so you can manage color using only your application software.

Parent topic: [Selecting Additional Layout and Print Options - Windows](#)

Image Options and Additional Settings - Windows

You can select any of the Image Options and Additional Settings to customize your print. Some options may be pre-selected or unavailable, depending on other settings you have chosen.

Image Options**Emphasize Text**

Adjusts the weight of printed text to increase readability.

Emphasize Thin Lines

Adjusts the weight of printed lines to increase visibility.

Edge Smoothing

Smooths jagged edges in low-resolution images such as screen captures or images from the Web.

Fix Red-Eye

Reduces or removes red-eye in photos.

Print Text in Black

Prints colored text in black.

For Color Text

Prints colored text on a background pattern or underlined.

For Color Graphs and Images

Prints colored graphics and images with overlay patterns.

For Color Text, Graphs, and Images

Prints colored text, graphics, and images with overlay patterns.

Enhancement Options

Specifies Color Universal Print enhancement settings for text, graphics, and images.

Additional Settings Options**Rotate 180°**

Prints the image rotated 180° from its original orientation.

Bidirectional Printing

Prints in both directions (right-to-left and left-to-right), speeding up printing, but may reduce print quality.

Mirror Image

Flips the printed image left to right.

Parent topic: [Selecting Additional Layout and Print Options - Windows](#)

Header/Footer Settings - Windows

You can select any of the Header/Footer Settings options to add headers or footers when you print. The items are available to print at the top or bottom of your pages, in either the left, right, or center of the page.

Note: These settings are not saved with your document.

The screenshot shows the 'Header/Footer Settings' dialog box. It is organized into several sections:

- Positional Settings:** A grid of six dropdown menus for selecting header/footer content. The top row includes 'Top Left' (User Name), 'Top Center' (None), and 'Top Right' (Date/Time). The bottom row includes 'Bottom Left' (None), 'Bottom Center' (None), and 'Bottom Right' (None).
- Page Settings:** Two spinners for 'Starting number' and 'Start printing on page', both set to 1.
- Text Input:** A text field labeled 'Text' which is currently empty.
- Appearance Settings:** A section for styling the header/footer text, including:
 - Color:** A dropdown menu set to 'Black'.
 - Font:** A dropdown menu set to 'Arial'.
 - Size:** A spinner set to '11 pt' with a range of '[6 ... 72]'.
 - Style:** A text box containing 'Bold' and 'Italic' options.
- Buttons:** Four buttons at the bottom: 'Reset Defaults', 'OK', 'Cancel', and 'Help'.

You can select to print the following information:

- User Name
- Computer Name
- Date
- Date/Time
- Document Name
- Collate Number
- Page Number
- Text

You can also adjust the text settings for the printed information.

Note: The user name, computer name, date, and time come from the Windows Control Panel on your computer.

Parent topic: [Selecting Additional Layout and Print Options - Windows](#)

Selecting a Printing Preset - Windows

For quick access to common groups of print settings, you can select a printing preset on the **Main** or **More Options** tab.



Note: You can create your own preset by clicking the **Add/Remove Presets** button.

1. Click the **Main** or **More Options** tab.
You see the available **Printing Presets** on the left:
2. Place your cursor over one of the **Printing Presets** to view its list of settings.
3. Click on a preset to change its settings or delete it, or use any of the available options on the screen to control your printing presets.
4. To choose a preset for printing, select it.
5. Click **OK**.

Parent topic: [Printing with Windows](#)

Selecting Extended Settings - Windows

You can select additional settings that apply to all the print jobs you send to your product.

1. Access the Windows Desktop and right-click the  icon for your product in the right side of the Windows taskbar, or click the up arrow and right-click .
2. Select **Printer Settings**.
3. Click the **Maintenance** tab.

You see the maintenance options:

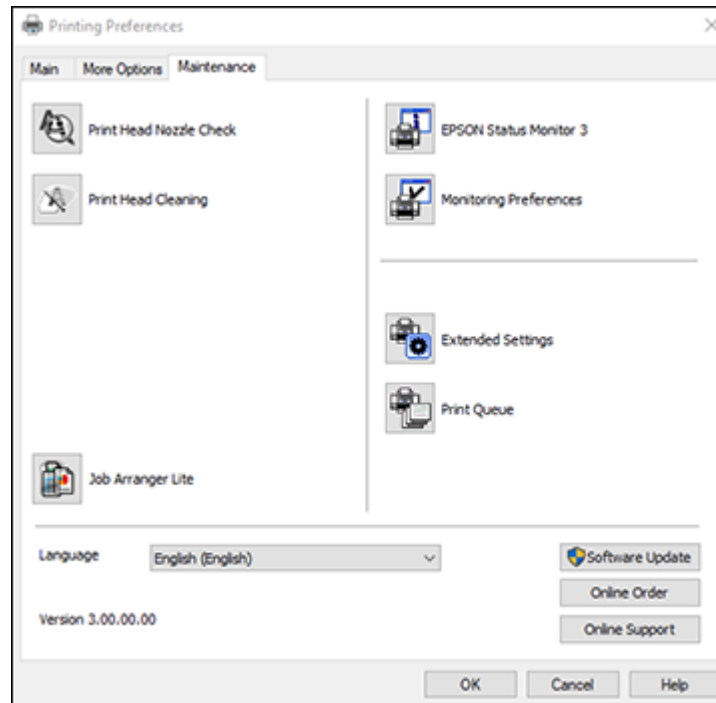

4. Click the **Extended Settings** button.

You see this window:

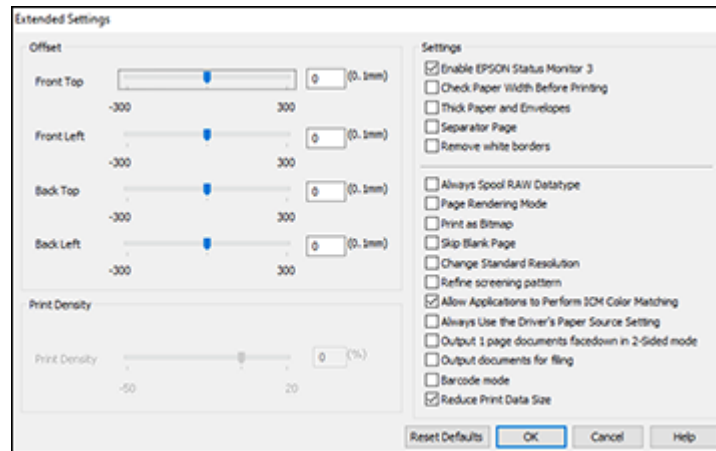

5. Select any of the extended settings to customize your print.
6. Click **OK** to close the Extended Settings window.
7. Click **OK** to close the printer software window.

[Extended Settings - Windows](#)

Parent topic: [Printing with Windows](#)

Extended Settings - Windows

You can select these settings on the Extended Settings window.

Enable EPSON Status Monitor 3

Enables product monitoring for ink and paper supplies and other issues.

Check Paper Width Before Printing

Prevents printing beyond the edges of the paper if the paper size setting is incorrect; may reduce print speed.

Thick Paper and Envelopes

Prevents ink from smearing when you print on envelopes or other thick paper.

Separator Page

Before each document, prints a separator page containing the title, user, date, and time.

Remove white borders

Removes white margins that may appear when you print borderless photos.

Always Spool RAW Datatype

Increases print speed and may solve other printing problems.

Page Rendering Mode

Increases print speed when printing is extremely slow or the print head stops during printing.

Print as Bitmap

Increases print speed when printing is extremely slow or the print head stops during printing, and other settings do not help.

Skip Blank Page

Ensures that your product does not print pages that contain no text or images.

Change Standard Resolution

Reduces the resolution of print data to correct printing problems.

Refine screening pattern

Prints graphics with a finer screening pattern.

Allow Applications to Perform ICM Color Matching

Allows applications to perform ICM color matching.

Always Use the Driver's Paper Source Setting

Prints using the paper source setting in the printer driver, rather than the setting in your application.

Output 1 page documents facedown in 2-Sided mode

Outputs single-sided pages in a 2-sided print job facedown instead of faceup.

Output documents for filing

Outputs all landscape, portrait, 1-sided, and 2-sided documents in the same orientation for easier filing.

Barcode mode

Reduces bleeding when printing barcodes on plain paper, letterhead paper, recycled paper, preprinted paper, envelopes, and thick paper.

Reduce Print Data Size

Increases print data compression to improve print speed. Not recommended when printing fine patterns.

Parent topic: [Selecting Extended Settings - Windows](#)

Printing Your Document - Windows

Once you have selected your print settings, you are ready to save your settings and print.

1. Click **OK** to save your settings.

You see your application's Print window, such as this one:

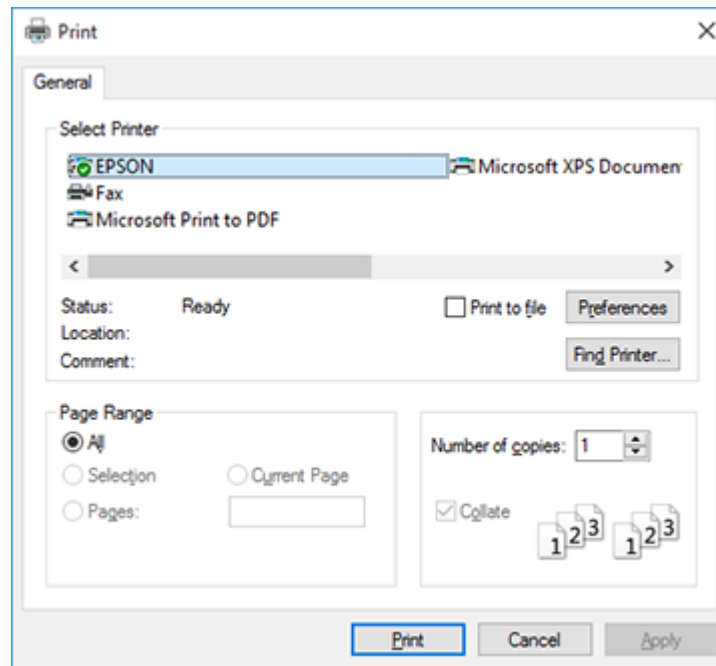



2. Click **OK** or **Print** to start printing.

Parent topic: [Printing with Windows](#)

Locking Printer Settings - Windows

Windows administrators can lock access to some printer settings to prevent unauthorized changes.

1. Do one of the following:

- **Windows 10:** Click  and select  (Settings) > **Devices** > **Printers & scanners**. Select your product name and select **Manage** > **Printer properties**.
- **Windows 8.x:** Navigate to the **Apps** screen and select **Control Panel** > **Hardware and Sound** > **Devices and Printers**. Right-click your product and select **Printer properties**.
- **Windows 7:** Click  and select **Devices and Printers**. Right-click your product and select **Printer properties**.

- **Windows Vista:** Click  and select **Control Panel**. Click **Printer** under **Hardware and Sound**, then right-click your product and select **Properties**.
2. Click the **Optional Settings** tab.

Note: You can prevent access to the **Optional Settings** tab by changing the user or group permissions in the **Security** tab.

3. Click **Driver Settings**.

You see this window:

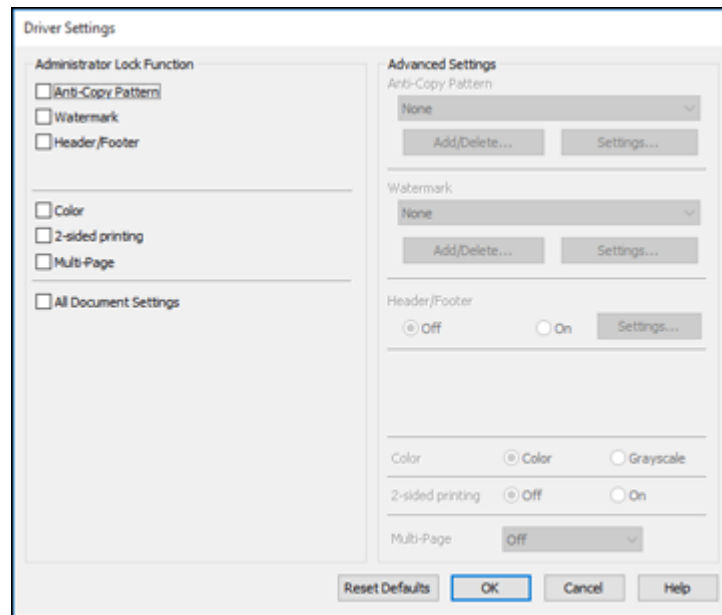

4. Select the checkbox for each setting you want to lock. To lock all print settings, select **All Document Settings**.
5. Under **Advanced Settings**, select the setting option you want to use for each locked setting.
6. Click **OK**.

[Locked Setting Options](#)

Parent topic: [Printing with Windows](#)

Locked Setting Options

Select the options you want to use for any locked print settings.



Setting	Options	Description
Anti-Copy Pattern	Various data items	Lets you select the data to use for the pattern or prohibit anti-copy patterns
	Add/Delete	Lets you add or delete a customized anti-copy pattern
	Settings	Lets you select the arrangement, size, and other settings for the custom anti-copy pattern
Watermark	Various text watermarks	Lets you select the text for the watermark or prohibit watermarks
	Add/Delete	Lets you add or delete a customized text or image-based watermark
	Settings	Lets you select the size, position, and other watermark settings
Header/Footer	Off	Prohibits headers or footers
	On	Allows headers and footers
	Settings	Lets you select the text and position for printing headers and footers
Color	Color	Allows color printing
	Grayscale	Allows printing in black or shades of gray only
2-sided printing	Off	Allows printing on one side of the paper only
	On	Allows printing on both sides of the paper
Multi-Page	Off	Prohibits multi-page settings
	2-Up	Allows printing of 2 pages on one sheet of paper
	4-Up	Allows printing of 4 pages on one sheet of paper
	6-Up	Allows printing of 6 pages on one sheet of paper
	8-Up	Allows printing of 8 pages on one sheet of paper
	9-Up	Allows printing of 9 pages on one sheet of paper
	16-Up	Allows printing of 16 pages on one sheet of paper

Setting	Options	Description
All Document Settings	—	Lets you lock all print settings

Parent topic: [Locking Printer Settings - Windows](#)

Selecting Default Print Settings - Windows

When you change your print settings in a program, the changes apply only while you are printing in that program session. If you want to change the print settings you use in all your Windows programs, you can select new default print settings.

1. Access the Windows Desktop and right-click the  icon for your product in the right side of the Windows taskbar, or click the up arrow and right-click .
2. Select **Printer Settings**.

You see the printer settings window:

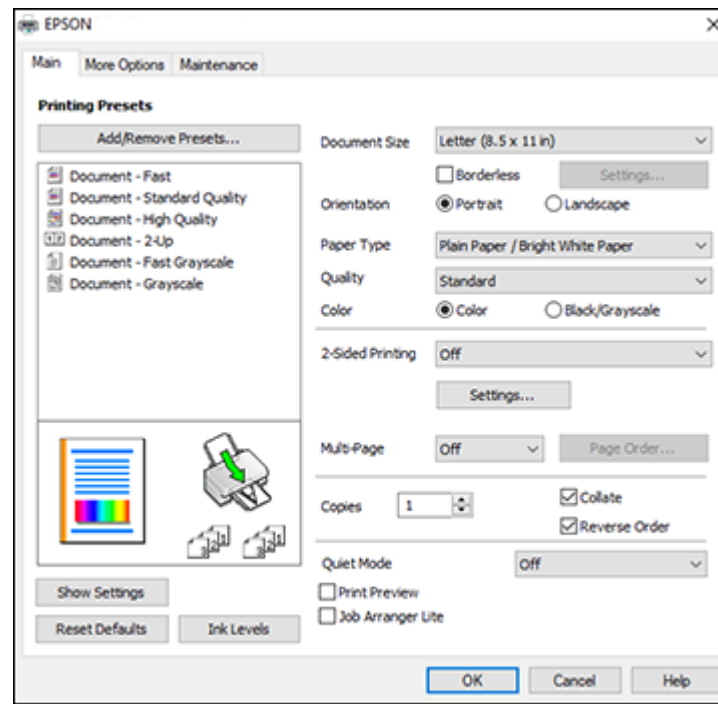

3. Select the print settings you want to use as defaults in all your Windows programs.
4. Click **OK**.



These settings are now the defaults selected for printing. You can still change them as needed for printing in any program session.

[Changing the Language of the Printer Software Screens](#)

Parent topic: [Printing with Windows](#)

Changing the Language of the Printer Software Screens

You can change the language used on the Windows printer software screens.

1. Access the Windows Desktop and right-click the  icon for your product in the right side of the Windows taskbar, or click the up arrow and right-click .
2. Select **Printer Settings**.
You see the printer settings window.
3. Click the **Maintenance** tab.

You see the maintenance options:

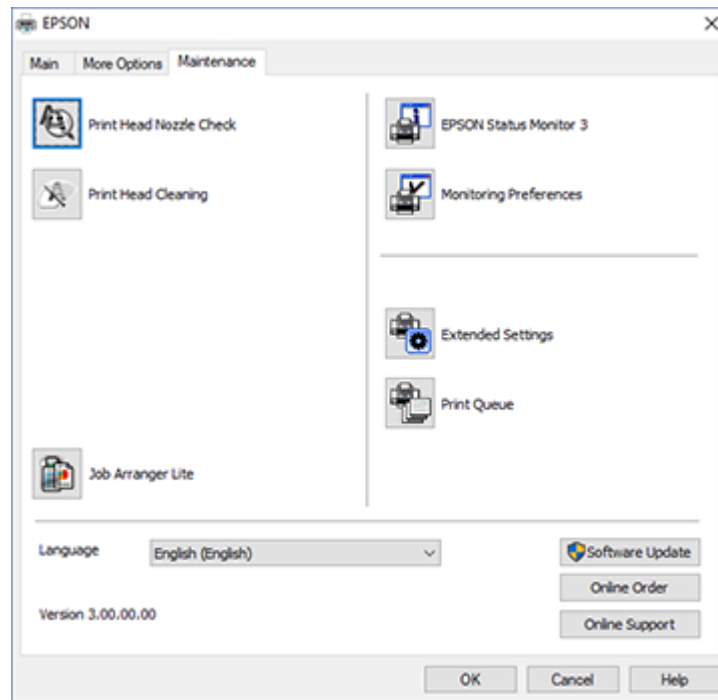



4. Select the language you want to use as the **Language** setting.
5. Click **OK** to close the printer software window.

The printer software screens appear in the language you selected the next time you access them.

Parent topic: [Selecting Default Print Settings - Windows](#)

Changing Automatic Update Options

Your printer software for Windows automatically checks for updates to the product software. You can change how often the software checks for updates or disable this feature.

1. Access the Windows Desktop and right-click the  icon for your product in the right side of the Windows taskbar, or click the up arrow and right-click .
2. Select **Software Update Settings**.

You see this window:

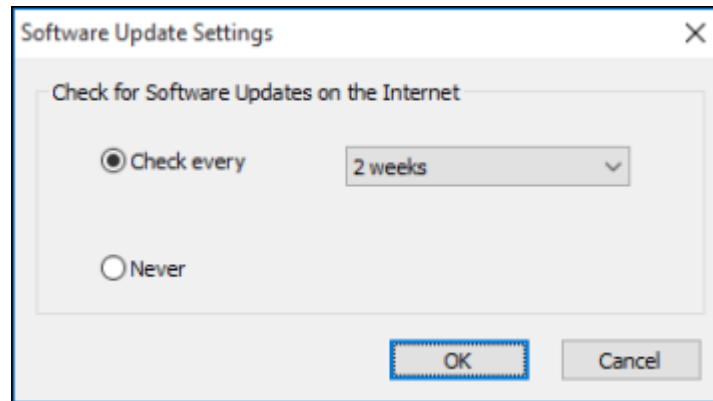

3. Do one of the following:
 - To change how often the software checks for updates, select a setting in the **Check every** menu.
 - To disable the automatic update feature, select the **Never** option.
4. Click **OK** to exit.

Note: If you choose to disable the automatic update feature, you can check for updates manually.

Parent topic: [Printing with Windows](#)

Printing with the Built-in Epson Driver - Windows 10 S

You can print with the built-in Epson printer driver using any printing program on Windows 10 S, as described in these sections.

Note: The built-in Epson driver in Windows 10 S does not include all the available print settings for your product. To print with additional settings, download and install the Epson Print and Scan utility from the Windows Store. You cannot download and install any Epson product software from the Epson website for use with Windows 10 S; you must obtain software only from the Windows Store.

[Selecting Print Settings - Windows 10 S](#)

Parent topic: [Printing from a Computer](#)

Selecting Print Settings - Windows 10 S

Select the settings for your print job in your Windows 10 S application.

1. Select the print command in your application.

Note: You may need to select a print icon on your screen, the **Print** option in the **File** menu, or another command. See your application's help utility for details.

2. If necessary, select your product name as the printer you want to use.

Note: You may also need to select **Properties** or **Preferences** to view your print settings.

You see a window like this:

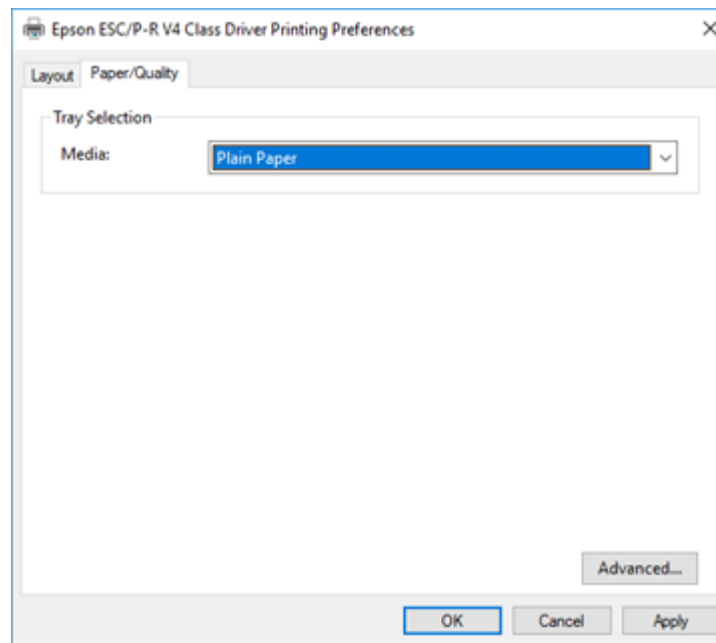

3. Select the type of paper you loaded as the **Media** setting.

Note: The setting may not exactly match the name of your paper. Check the paper type settings list for details.

4. Click the **Advanced** button.

You see a window like this:

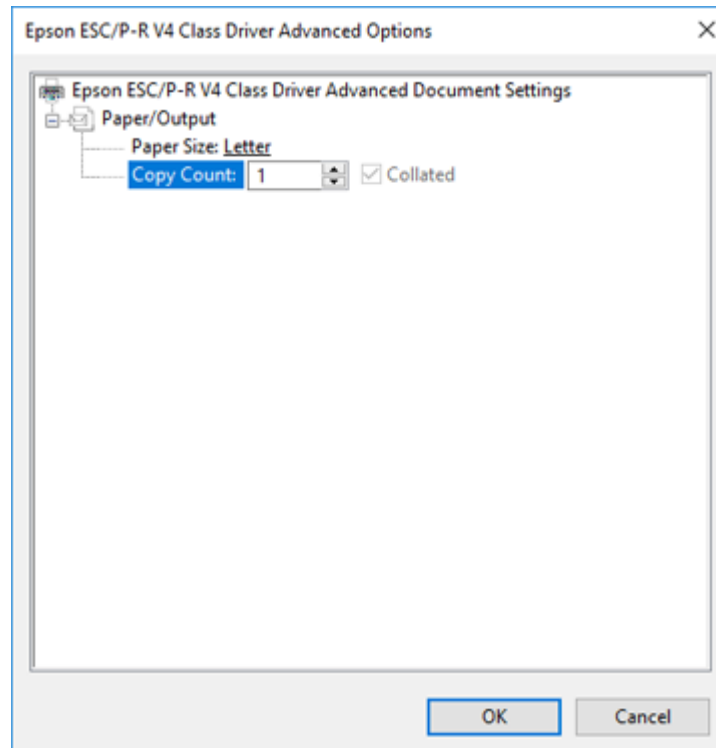

5. Select the size of the paper you loaded as the **Paper Size** setting.
6. To print multiple copies, select or enter the number as the **Copy Count** setting.
7. To print multiple copies of multi-page documents in sets, select the **Collated** checkbox.
8. Click **OK**.

You return to the printing preferences window.

9. Select the **Layout** tab.

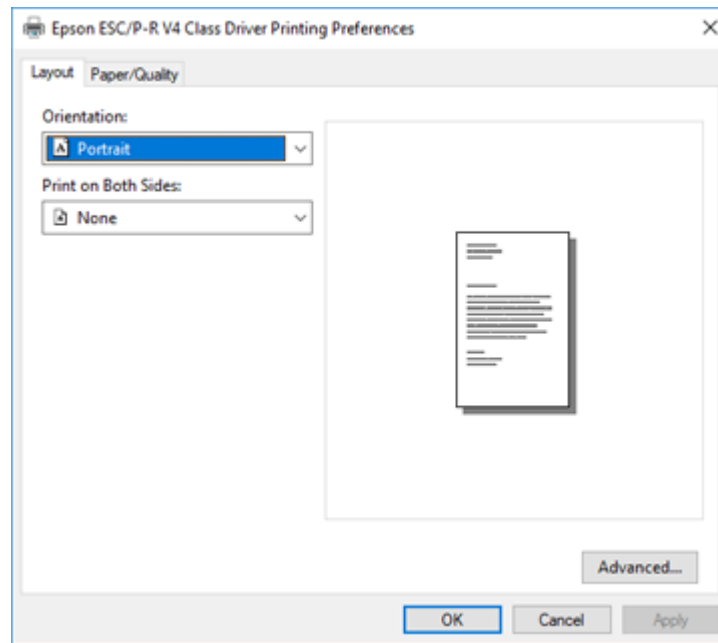

10. Select the orientation of your document as the **Orientation** setting.

11. To print double-sided, select one of the **Print on Both Sides** options, depending on how you want to orient the page layout. The icon next to each option shows the layout.

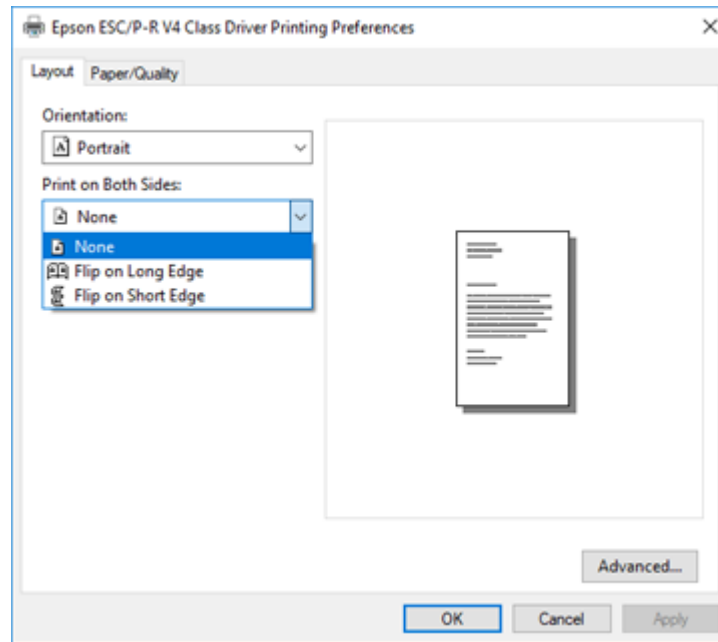

12. Click **OK** to save your settings.

You see your application's **Print** window.

13. Click **OK** or **Print** to start printing.

Parent topic: [Printing with the Built-in Epson Driver - Windows 10 S](#)

Printing on a Mac

You can print with your product using any Mac printing program, as described in these sections.

Note: If you have an Internet connection, it is a good idea to check for updates to your product software on Epson's support website.

[Selecting Basic Print Settings - Mac](#)

[Selecting Page Setup Settings - Mac](#)

- [Selecting Print Layout Options - Mac](#)
 - [Selecting Double-sided Printing Settings - Mac](#)
 - [Managing Color - Mac](#)
 - [Selecting Printing Preferences - Mac](#)
 - [Printing Your Document or Photo - Mac](#)
- Parent topic:** [Printing from a Computer](#)

Selecting Basic Print Settings - Mac

Select the basic settings for the document or photo you want to print.

1. Open a photo or document for printing.
2. Select the print command in your application.

Note: You may need to select a print icon on your screen, the **Print** option in the File menu, or another command. See your application's help utility for details.

3. Select your product as the **Printer** setting.

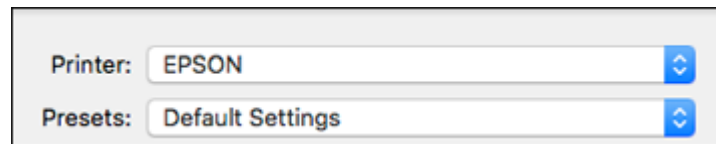

4. If necessary, click the arrow next to the Printer setting or the **Show Details** button to expand the print window.

You see the expanded printer settings window for your product:

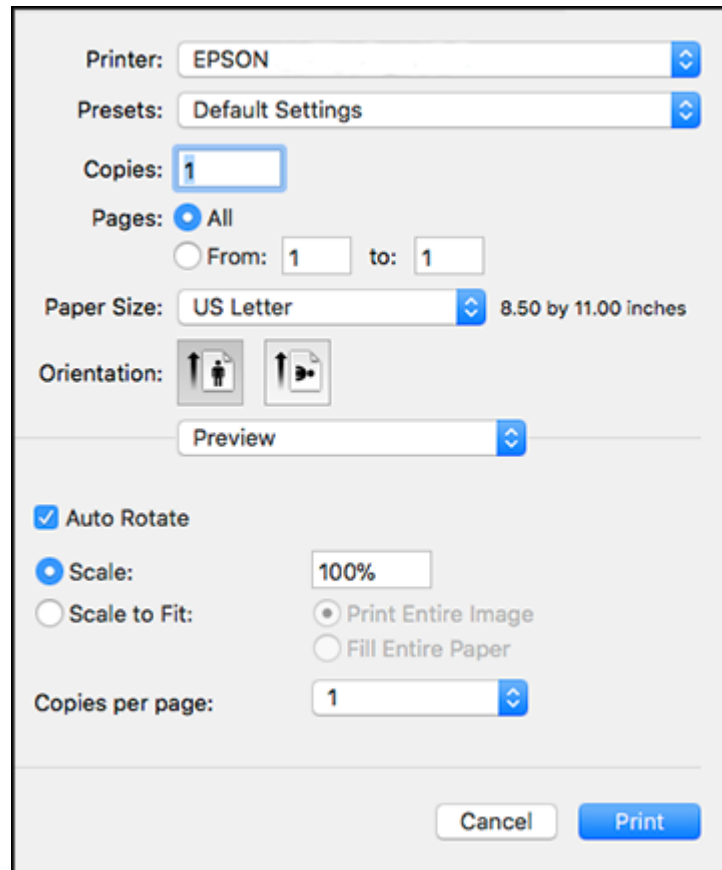

Note: The print window may look different, depending on the Mac OS version and the application you are using.

5. To use an existing set of print settings, select **Presets** and choose a preset from the list.
6. Select the **Copies** and **Pages** settings as necessary.

Note: If you do not see these settings in the print window, check for them in your application before printing.

7. Select the page setup options: **Paper Size** and **Orientation**.

Note: If you do not see these settings in the print window, check for them in your application before printing. They may be accessible by selecting **Page Setup** from the File menu.

8. Select any application-specific settings that appear on the screen, such as those shown in the image above for the Preview application.
9. Select **Print Settings** or **Printer Features** from the pop-up menu.

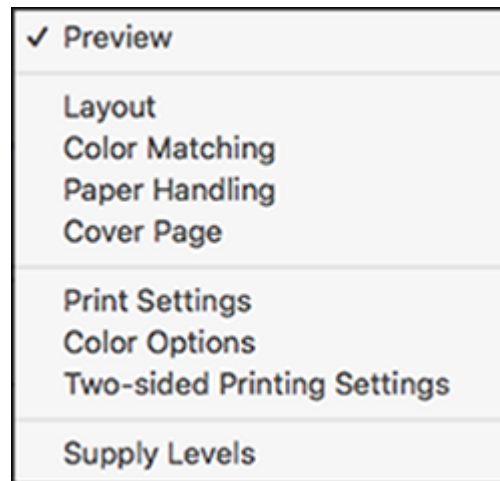

You see these settings:

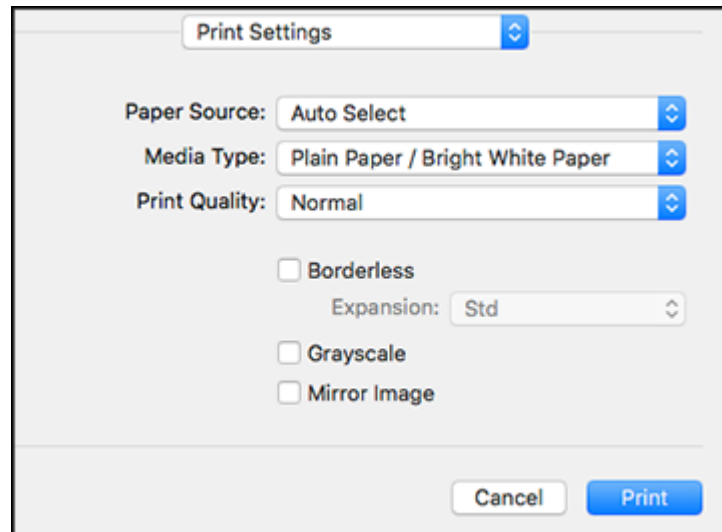

Note: The available print settings and appearance of the print window may be different than those covered here, depending on the Mac OS version and the application you are using.

10. Select the **Paper Source** you wish to print from.
11. Select the type of paper you loaded as the **Media Type** setting.

Note: The setting may not exactly match the name of your paper. Check the paper type settings list for details.

12. Select the **Print Quality** setting you want to use.
13. Select the **Borderless** checkbox if you want to print a borderless photo. If the option is grayed out, change the **Media Type** setting to a paper type that supports borderless printing.
14. Select any of the available print options.

15. If you want to save your settings as a new printing preset, select **Presets** and then select **Save current settings as Preset**.

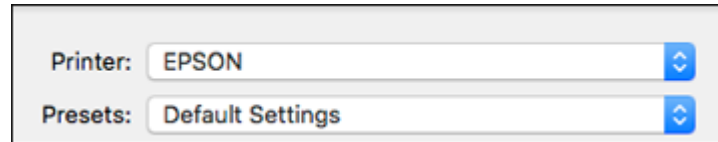

[Paper Source Options - Mac](#)

[Print Quality Options - Mac](#)

[Print Options - Mac](#)

Parent topic: [Printing on a Mac](#)

Related references

[Paper or Media Type Settings - Printing Software](#)

Related tasks

[Selecting Page Setup Settings - Mac](#)

[Printing Your Document or Photo - Mac](#)

Paper Source Options - Mac

You can select any of the available options in the Paper Source menu to print on the paper loaded in that source.

Auto Select

Automatically selects the paper source based on the selected paper size.

Cassette 1

Selects the paper in cassette 1 as the paper source.

Cassette 2

Selects the paper in cassette 2 as the paper source.

Parent topic: [Selecting Basic Print Settings - Mac](#)

Print Quality Options - Mac

You can select any of the available Print Quality options to fine-tune the quality of your print. Some settings may be unavailable, depending on the paper type setting you have chosen.

Draft

For draft printing on plain paper.

Normal

For everyday text and image printing.

Fine

For text and graphics with good quality and print speed.

Parent topic: [Selecting Basic Print Settings - Mac](#)

Print Options - Mac

You can select any of the print options to customize your print. Some options may be unavailable, depending on other settings you have chosen.

Expansion

If you selected a borderless paper size setting, this option adjusts the image expansion settings to control printing at the edges of borderless prints.

Grayscale

Prints text and graphics in black or shades of gray.

Mirror Image

Lets you flip the printed image horizontally.

Note: If you select the **Min** option for the Expansion setting, you may see white borders on your printed photo.

Parent topic: [Selecting Basic Print Settings - Mac](#)

Selecting Page Setup Settings - Mac

Depending on your application, you may be able to select the paper size and orientation settings from the print window.

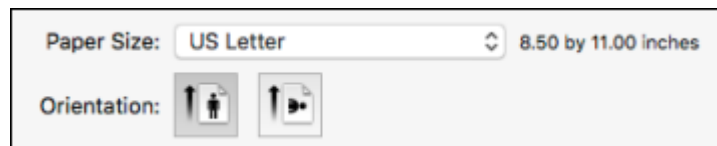

Note: If you do not see these settings in the print window, check for them in your application before printing. They may be accessible by selecting **Page Setup** from the File menu.

1. Select the size of the paper you loaded as the **Paper Size** setting. If you are printing a borderless photo, select the **Borderless** checkbox or a paper size with a **Borderless** option. You can also select a custom setting to create a custom paper size.

Note: You must select a compatible borderless paper type and size to print without borders. Check the borderless paper compatibility list for details.

2. Select the orientation of your document or photo as shown in the print window.

Note: If you are printing an envelope, select the  icon.

Note: You can reduce or enlarge the size of the printed image by selecting **Paper Handling** from the pop-up menu and selecting a scaling option.

Parent topic: [Printing on a Mac](#)

Related references

[Borderless Paper Type Compatibility](#)

Selecting Print Layout Options - Mac

You can select a variety of layout options for your document or photo by selecting **Layout** from the pop-up menu on the print window.

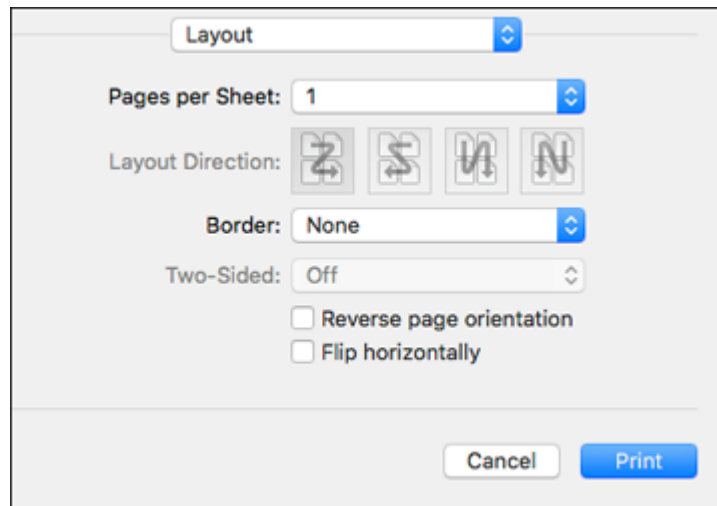

- To print multiple pages on one sheet of paper, select the number of pages in the **Pages per Sheet** pop-up menu. To arrange the print order of the pages, select a **Layout Direction** setting.
- To print borders around each page on the sheet, select a line setting from the **Border** pop-up menu.
- To print on both sides of each page, select a setting from the **Two-Sided** pop-up menu.
- To invert or flip the printed image, select the **Reverse page orientation** or **Flip horizontally** settings.

Parent topic: [Printing on a Mac](#)

Selecting Double-sided Printing Settings - Mac

You can print on both sides of the paper by selecting **Two-sided Printing Settings** from the pop-up menu on the print window.

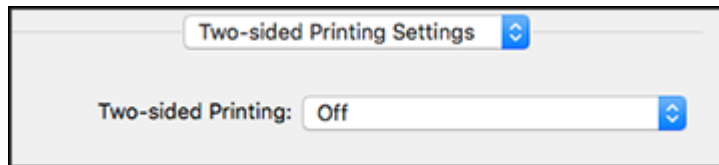

Note: Some options may be pre-selected or unavailable, depending on other settings you have chosen or if you are accessing the product over a network. This screen may be different, depending on the Mac OS version you are using.

1. Select one of the **Two-sided Printing** options.

2. Select the type of document you are printing as the **Document Type** setting. The software automatically sets the Adjustments options for that document type.

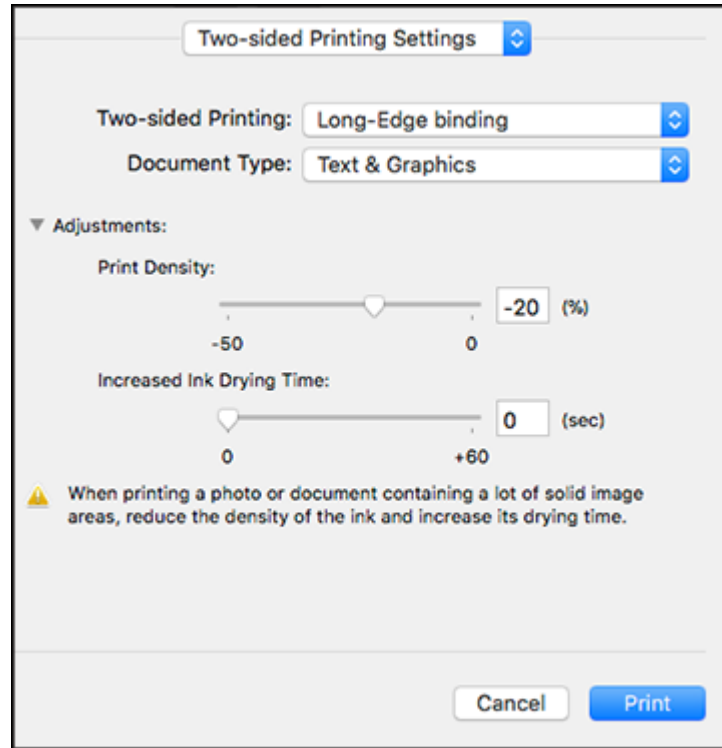

3. If necessary, customize the Adjustments settings as instructed on the screen.
4. Print a test copy of your double-sided document to test the selected settings.
5. Follow any instructions displayed on the screen during printing.

[Double-sided Printing Options and Adjustments - Mac](#)

Parent topic: [Printing on a Mac](#)

Double-sided Printing Options and Adjustments - Mac

You can select any of the available options in the **Two-sided Printing Settings** or **Output Settings** pop-up menu to set up your double-sided print job.

Long-Edge binding

Orients double-sided printed pages to be bound on the long edge of the paper.

Short-Edge binding

Orients double-sided printed pages to be bound on the short edge of the paper.

Print Density

Sets the level of ink coverage for double-sided printing.

Increased Ink Drying Time

Sets the amount of time required for drying ink after printing on one side of the paper before printing the other side in double-sided printing.

Parent topic: [Selecting Double-sided Printing Settings - Mac](#)

Managing Color - Mac

You can adjust the Color Matching and Color Options settings to fine-tune the colors in your printout or turn off color management in your printer software.

1. Select **Color Matching** from the pop-up menu in the print window.

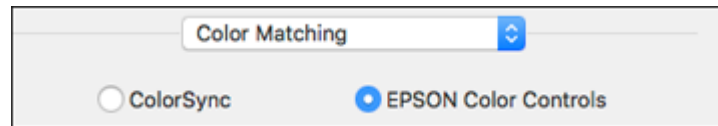

2. Select one of the available options.

3. Select **Color Options** from the pop-up menu in the print window.

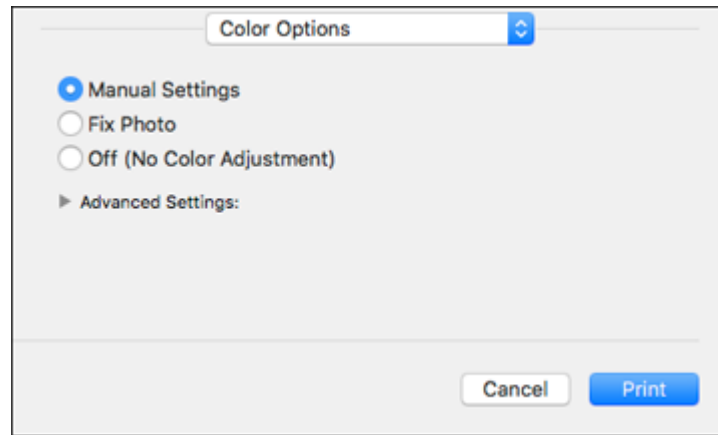

Note: The available settings on the Color Options menu depend on the option you selected on the Color Matching menu.

4. Select one of the available options.

[Color Matching and Color Options - Mac](#)

Parent topic: [Printing on a Mac](#)

Color Matching and Color Options - Mac

You can select these settings on the **Color Matching** and **Color Options** menus.

Color Matching Settings

EPSON Color Controls

Lets you manage color using controls in your printer driver or turn off color management.

ColorSync

Prints using standard color profiles for your product and paper to help match image colors. You can customize the conversion method and filter settings on the ColorSync pop-up menu in the print window.

Color Options Settings

Manual Settings

Lets you select manual color adjustments. Click the arrow next to **Advanced Settings** and select settings for **Brightness**, **Contrast**, **Saturation**, and individual color tones. You can also select a color **Mode** setting for printing photos and graphics and the **Fix Red-Eye** setting to reduce or remove red-eye in photos. Depending on the selected color mode, you can also adjust the midtone density using the **Gamma** setting.

Fix Photo

Improves the color, contrast, and sharpness of flawed photos.

Note: Fix Photo uses a sophisticated face recognition technology to optimize photos that include faces. For this to work, both eyes and the nose must be visible in the subject's face. If your photo includes a face with an intentional color cast, such as a statue, you may want to turn off **Fix Photo** to retain the special color effects.

Off (No Color Adjustment)

Turns off color management in your printer software so you can manage color using only your application software.

Note: An ICC profile is required if color management is turned off.

Parent topic: [Managing Color - Mac](#)

Selecting Printing Preferences - Mac

You can select printing preferences that apply to all the print jobs you send to your product.

1. In the Apple menu or the Dock, select **System Preferences**.
2. Select **Print & Fax**, **Print & Scan**, or **Printers & Scanners**, select your product, and select **Options & Supplies**.
3. Select **Driver** or **Options**.

You see a screen like this:

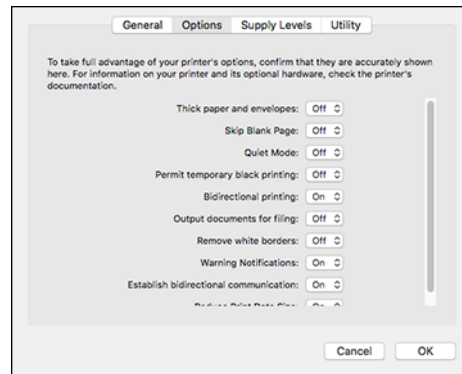

4. Select any of the available printing preferences.
5. Click **OK**.

[Printing Preferences - Mac](#)

Parent topic: [Printing on a Mac](#)

Printing Preferences - Mac

You can select these settings on the **Options** or **Driver** tab.

Thick Paper and Envelopes

Prevents ink from smearing when you print on envelopes or other thick paper.

Skip Blank Page

Ensures that your product does not print pages that contain no text or images.

Quiet Mode

Lessens noise during printing but may decrease print speed.

Permit temporary black printing

Allows you to print using black ink when color ink is expended.

Automatic Cassette Switching

Automatically switches to the other cassette when one of the cassettes runs out of paper.

Bidirectional printing

Prints in both directions (right-to-left and left-to-right), speeding up printing, but may reduce print quality.

Output documents for filing

Outputs all landscape, portrait, 1-sided, and 2-sided documents in the same orientation for easier filing.

Remove white borders

Removes white margins that may appear when you print borderless photos.

Warning Notifications

Lets you choose whether or not to receive warning notifications from the printer software for various operating conditions.

Establish bidirectional communication

Allows the product to communicate with the computer. Do not change the default setting unless you experience issues when using a shared printing pool.

Reduce Print Data Size

Increases print data compression to improve print speed. Not recommended when printing fine patterns.

Parent topic: [Selecting Printing Preferences - Mac](#)

Printing Your Document or Photo - Mac

Once you have selected your print settings, you are ready to print.

Click **Print** at the bottom of the print window.

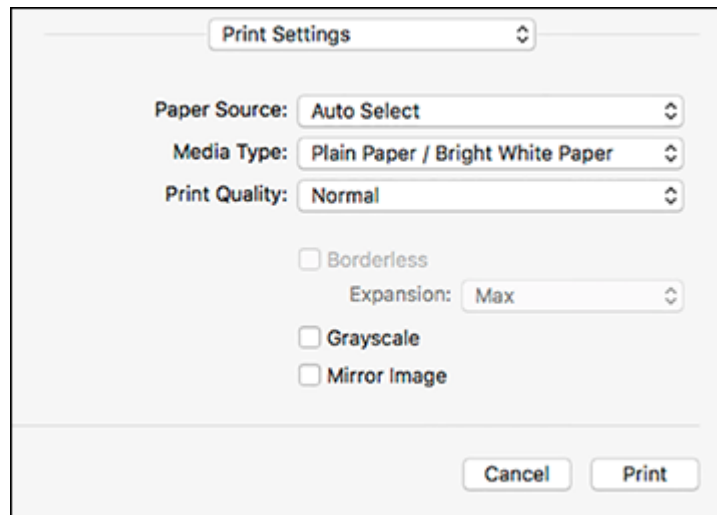

Checking Print Status - Mac

Parent topic: [Printing on a Mac](#)

Checking Print Status - Mac



During printing, you can view the progress of your print job, control printing, and check ink status.

1. Click the printer icon when it appears in the Dock.

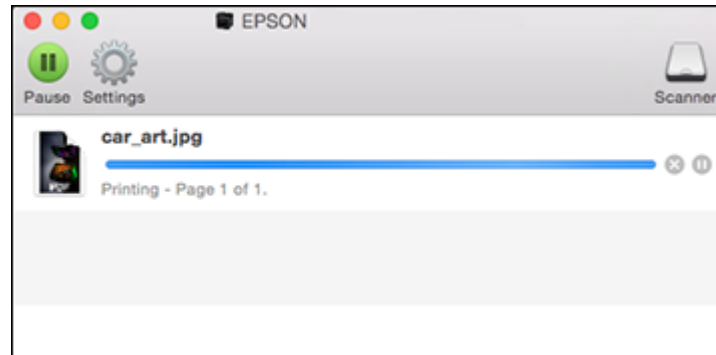
You see the print status window:



2. Select the following options as necessary for your Mac OS version:

- To cancel printing, click the print job and click  or **Delete**.
- To pause a print job, click the print job and click  or **Hold**. To resume a print job, click the paused print job and click  or **Resume**.
- To pause printing for all queued print jobs, click **Pause** or **Pause Printer**.
- To display other printer information, click **Settings** or **Supply Levels**.

Parent topic: [Printing Your Document or Photo - Mac](#)

Printing from a Smartphone or Tablet

You can print from a smartphone or tablet running iOS or Android using the Epson Smart Panel app.

Note: Your device must be connected to the same wireless network as your Epson product, and Epson Smart Panel must be configured for use with your product.

1. Download the Epson Smart Panel app from your device's app store or from Epson's website. See the link below.
2. Open the Epson Smart Panel app and select a print menu on the home screen.
3. Follow the on-screen instructions to begin printing.

Parent topic: [Printing from a Computer](#)

Related tasks

[Using the Epson Smart Panel Mobile App](#)

[Setting Up Wireless Printing from a Smart Device Using Epson Smart Panel](#)

Cancelling Printing Using the Product

If you need to cancel printing, select **Cancel**, then select **Cancel** again to confirm.

Parent topic: [Printing from a Computer](#)

Scanning

You can scan your originals and save them as digital files.

[Starting a Scan](#)

[Scanning a Document in Epson ScanSmart](#)

[Selecting Epson ScanSmart Settings](#)

[Scanning in Epson Scan 2](#)

Starting a Scan

After placing your originals on your product for scanning, start scanning using one of these methods.

[Starting a Scan Using the Product Control Panel](#)

[Setting Up and Scanning to a Network Folder or FTP Server](#)

[Starting a Scan Using the Epson Scan 2 Icon](#)

[Starting a Scan from a Scanning Program](#)

[Starting a Scan from a Smartphone or Tablet](#)

Parent topic: [Scanning](#)

Starting a Scan Using the Product Control Panel

You can scan an image to a variety of destinations using your product's control panel.

1. Make sure you installed the product software and connected the product to your computer or network.

Note: Restart your computer after installing the product software to enable scanning from the control panel.

2. Place your original on the product for scanning.

Note: To scan a double-sided or multi-page document, place your originals in the ADF.

3. Press the  home button, if necessary.
4. Select **Scan**.

You see a screen like this:

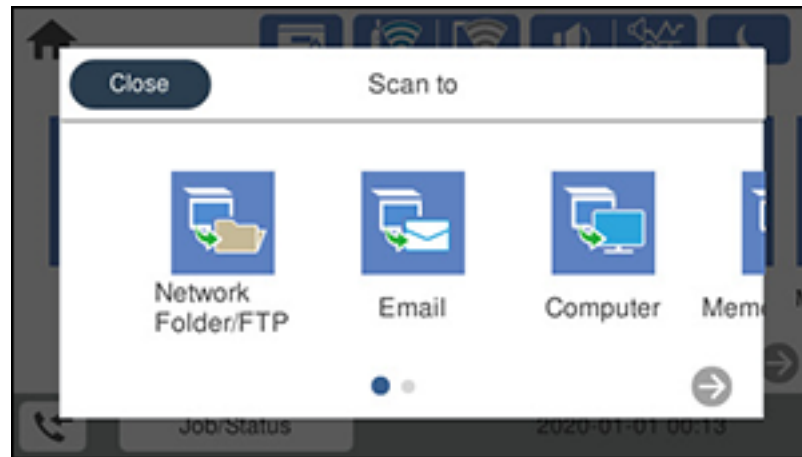

5. Select one of the following **Scan to** options:
 - **Network Folder/FTP** saves your scan file to a pre-defined folder on a network computer or FTP server. To use this feature, you must first create a shared network folder or obtain the FTP site address, and optionally register the location to your product's contact list.
 - **Email** lets you send scanned files through a pre-configured email server.
 - **Computer** lets you scan to a connected computer using your saved scan settings.
 - **Memory Device** saves your scan file on a USB device and lets you select the file format, quality, and other settings.
 - **Cloud** sends your scanned files to a destination that you have registered with Epson Connect.
 - **WSD** lets you manage network scanning in Windows 10, Windows 8.x, Windows 7, or Windows Vista (English only). To use this feature, you must first set up a WSD (Web Services for Devices) port on your Windows 7 or Windows Vista computer (the port is set up automatically on Windows 10 and Windows 8.x).
6. Follow the instructions in the links below to complete your scan.

[Scanning to Email](#)

[Scanning to a Connected Computer](#)

[Setting Up a WSD Port \(Windows 7/Windows Vista\)](#)

[Scanning to the Cloud](#)

[Scanning to a Memory Device](#)
[Control Panel Scanning Options](#)

Parent topic: [Starting a Scan](#)

Related tasks

[Using Epson Scan to Cloud](#)
[Entering Characters on the LCD Screen](#)
[Using Presets](#)

Related topics

[Setting Up and Scanning to a Network Folder or FTP Server](#)
[Placing Originals on the Product](#)

Scanning to Email

You can scan an original and email the scanned file using your product's control panel. You need to have a preconfigured email server before you can scan to email. You can either enter the email address directly on the product's control panel or select an address from the **Contacts** list. Make sure the date and time are set correctly so the time stamps on your emails are accurate.

1. Place your original on the product for scanning.

Note: To scan a double-sided or multi-page document, place all of the pages in the ADF.

2. Press the  home button, if necessary.
3. Select **Scan**.

You see a screen like this:

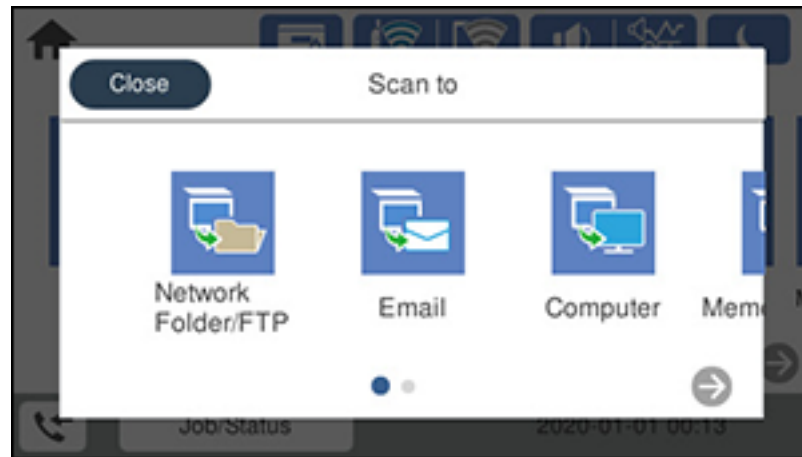

4. Select **Email**.

You see a screen like this:

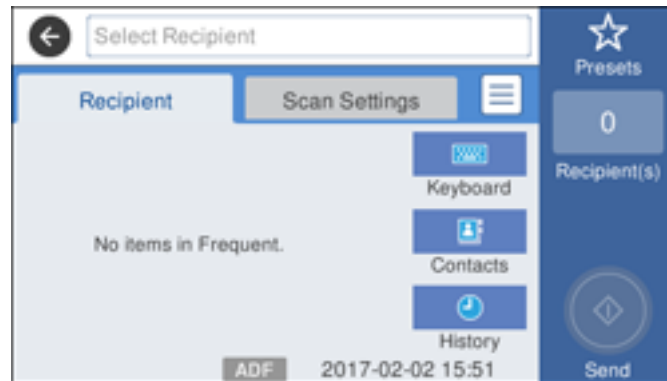

5. Do one of the following:

- Select **Contacts** and choose an email address from the **Contacts** list.
- Select **Keyboard** to use the displayed keyboard to enter the address for the recipient and press **OK**.

- Select **History** to choose an email address from your recent scan history.
 - Select an email address from any displayed frequent contacts.
6. Select **Scan Settings**.
 7. Select **File Format** to choose the file format for your scan.
 8. Scroll down and change the **Subject** and **File Name** settings if necessary.
 9. Select any additional scan settings as necessary.
 10. Select **Presets** to save your scan settings.
 11. Press the **Send** icon.

Your product scans your original and emails the scanned file.

Parent topic: [Starting a Scan Using the Product Control Panel](#)

Related references

[Control Panel Scanning Options](#)

Related tasks

[Configuring Email Server Settings](#)

[Entering Characters on the LCD Screen](#)

Related topics

[Placing Originals on the Product](#)

Scanning to a Connected Computer

You can scan an original and save it to a connected computer using your product's control panel. The computer must be connected using a USB cable or connected to the same network as your product.

You can save the scanned file as a JPEG or PDF file, or attach it to an email.

Note: Be sure you have installed Epson Scan 2 and ScanSmart on your computer before scanning to your computer.

1. Place your original on the product for scanning.

Note: To scan a multi-page document, place all of the pages in the ADF.

2. Press the  home button, if necessary.
3. Select **Scan**.

You see a screen like this:

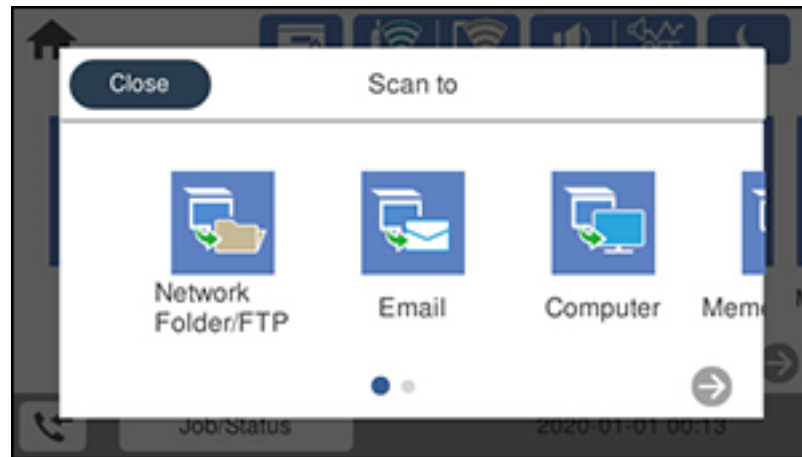

4. Select **Computer**.

You see a screen like this:

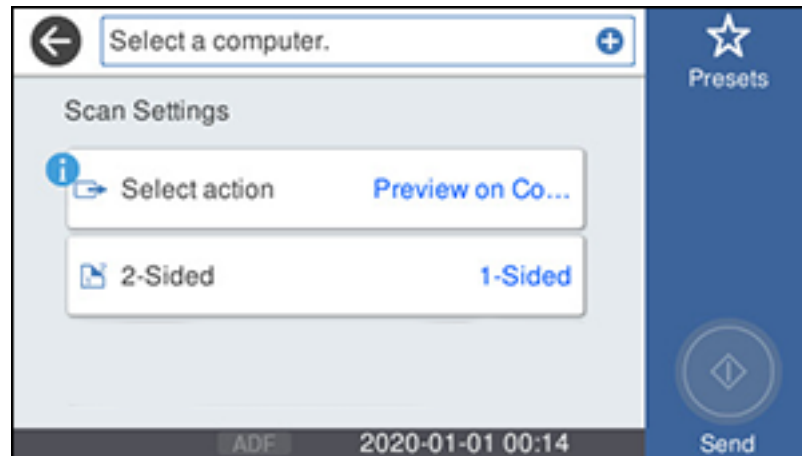

5. Select **Select action** and choose one of the following options:
 - **Preview on Computer** to preview the scan and select file save settings in ScanSmart.

- **Save as JPEG** to save the scanned image as a JPEG file.
 - **Save as PDF** to save the scanned document or image as a PDF file.
6. Change any of the displayed settings as necessary.
 7. Select **Save**.

Your product scans the original and sends the file to the connected computer.

Parent topic: [Starting a Scan Using the Product Control Panel](#)

Related references

[Control Panel Scanning Options](#)

Related topics

[Placing Originals on the Product](#)

Setting Up a WSD Port (Windows 7/Windows Vista)

You can scan to a networked Windows computer using WSD (Web Services for Devices). You must first set up a WSD port on your Windows 7 or Windows Vista system (the port is set up automatically on Windows 10 and Windows 8.x).

Before you set up a WSD port, make sure you installed your product software, and connected your product and computer to the same network.

1. Turn on your product.
2. Print a network status sheet so you can identify the network name and model name for your product on the network.
3. Click  or **Start** and select **Computer**.
4. On the left side of the window, select **Network**.
5. Locate your product on the Network screen, right-click it, and select **Install**.
6. When you see the User Account Control screen, click **Continue**.

Note: If you see an Uninstall screen, click **Uninstall** and repeat these steps as necessary.

7. When you see the message **Your device is ready to use** in the Windows taskbar, click the message.
8. On the Driver Software Installation screen, make sure your product is listed as **Ready to use**. Then click **Close**.

9. Do one of the following:

- **Windows 7:** Click  and select **Devices and Printers**.
- **Windows Vista:** Click **Start** and select **Control Panel > Hardware and Sound > Printers**.

10. Make sure that an icon appears for your product's name on the network.

When you use WSD, select your product name to scan over the network.

Parent topic: [Starting a Scan Using the Product Control Panel](#)

Related references

[Control Panel Scanning Options](#)

Related topics

[Placing Originals on the Product](#)

Scanning to the Cloud

You can use the control panel to send your scanned files to a destination that you have registered with Epson Connect.

Note: Make sure to set up your product using Epson Connect before using this feature.

1. Place your original on the product for scanning.
2. Press the  home icon, if necessary.
3. Select **Scan**.

You see a screen like this:

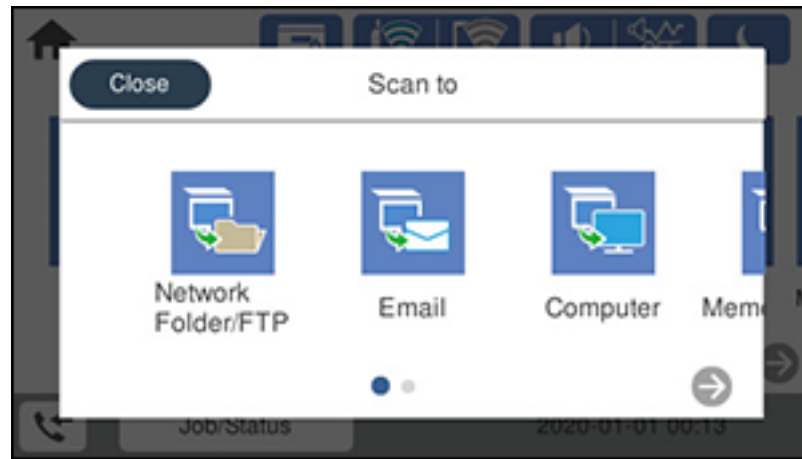

4. Select **Cloud**.

You see a screen like this:

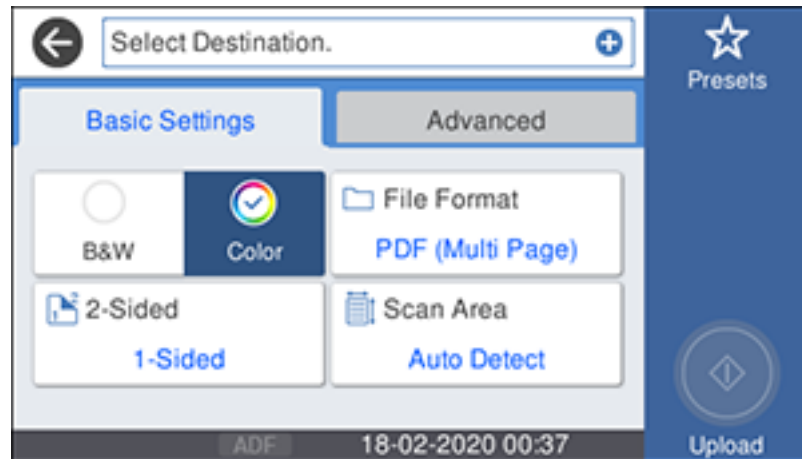

Note: You must register your product with Epson Connect to select a destination.

5. Select **Select Destination** to select a destination.
6. Change any of the displayed settings on the **Scan** tab as necessary.
7. Select the **Advanced Settings** tab to view and change additional scan settings, if necessary.
8. On the **Scan** tab, press the **Upload** icon to start scanning.

Your product scans your original and saves the scanned file to the selected destination.

Parent topic: [Starting a Scan Using the Product Control Panel](#)

Related references

[Control Panel Scanning Options](#)

Related topics

[Placing Originals on the Product](#)

Scanning to a Memory Device

You can scan an original and save the scanned image to a memory card or external USB device.

1. Insert a memory card into your product's memory card slot or connect an external USB device to the port on the front of the product.
2. Place your original on the product for scanning.
3. Press the  home icon, if necessary.
4. Select **Scan**.

You see a screen like this:

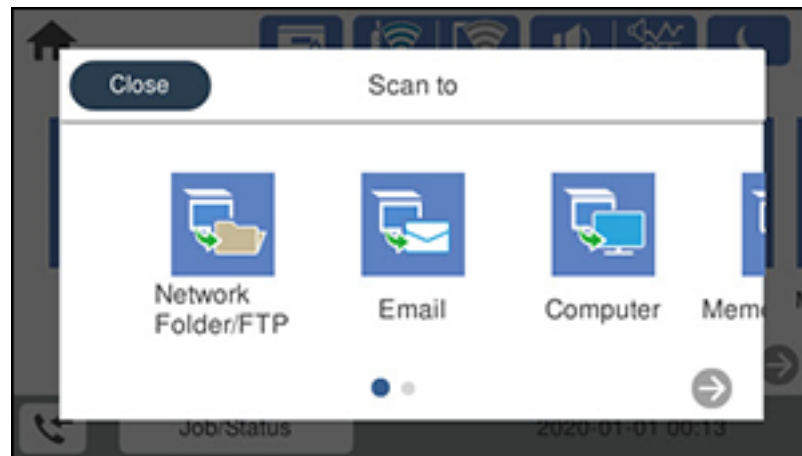

5. Select **Memory Device**.
You see a screen like this:

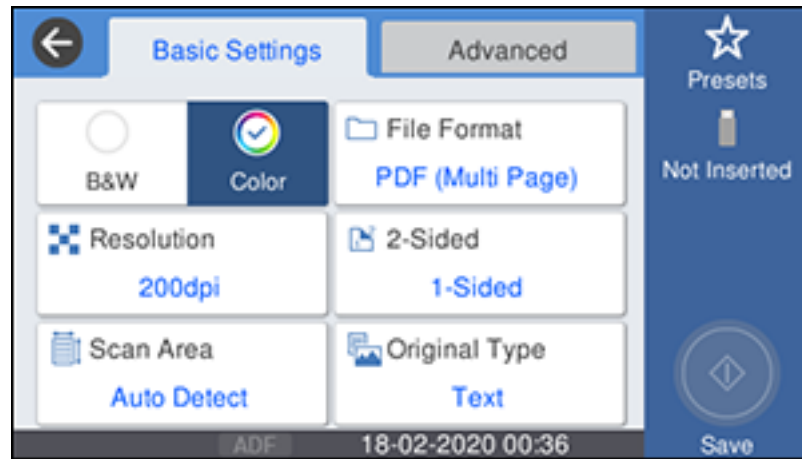

6. If prompted, select a device.
7. Change any of the displayed settings on the **Scan** tab as necessary.
8. Select the **Advanced** tab to view and change additional scan settings, if necessary.
9. On the **Basic Settings** tab, press the **Save** icon to start scanning.

Your product scans your original and saves the scanned file to the memory card or USB device.

Parent topic: [Starting a Scan Using the Product Control Panel](#)

Related references

[Control Panel Scanning Options](#)

Related topics

[Placing Originals on the Product](#)

Control Panel Scanning Options

Select the options you want to use for scanning.

Note: Not all options or settings may be available, depending on the **Scan to** option selected.

Scan to setting	Available options	Description
Edit Location	Communication Mode	Lets you select Network Folder (SMB) or FTP
	Location (Required)	Lets you enter a folder path in which to save scanned images
	User Name	Lets you enter a user name for the selected folder path
	Password	Lets you enter a password for the selected folder path
	Connection Mode	Lets you select the connection mode
	Port Number	Lets you enter a port number
Contacts	—	Select an email address or folder path to send or save scanned images
Color Mode	Color	Select whether to scan images in color or black and white
	B&W	
File Format	JPEG	Select for photos. You can also select the Compression Ratio .
	PDF (Single Page) PDF (Multi-Page) PDF/A (Single Page) PDF/A (Multi-Page)	Select for documents. You can also select the Compression Ratio and PDF Settings .
	TIFF (Single Page)	Select for scanned files that you can print from a device. Multi Page TIFF documents are scanned in black and white.
	TIFF (Multi Page)	
	Resolution	200dpi
300dpi		Select for photos
600dpi		Select for highest quality printing
2-Sided	Off	Lets you scan 2-sided originals placed in the ADF. If you select On , you can also select the Binding Direction .
	On	

Scan to setting	Available options	Description
Scan Area	Letter	Select the page size for documents, then select the orientation of the original
	A4	
	Legal	
	Half Letter	
	Envelope #10	
	5 × 7	
	4 × 6	
	8 × 10	
	Auto Cropping	Select for photos with dark edges
Max Area	Select for most photos	
Original Type	Text	Specifies the type of original you are scanning
	Text & Image	
	Photo	
Density	-4 to +4	Adjusts the lightness or darkness of scanned images.
Remove Shadow	On	Erases the shadows that appear in the center of a document when copying a book or the shadows that appear around a document when copying thick paper
	Off	
Remove Punch Holes	On	Erases the binding holes on a document
	Off	
Subject	—	Lets you enter a subject for your email
Attached File Max Size	Various sizes	Lets you select the maximum file size that can be attached to an email
File Name	—	Lets you enter a prefix, the date, and the time to the file name for your scanned file

Note: When you turn on password settings, you can use the LCD screen keyboard to set the password.

Parent topic: [Starting a Scan Using the Product Control Panel](#)

Setting Up and Scanning to a Network Folder or FTP Server

Before you can scan to a network folder on your computer or on an FTP server, you need to create a shared folder and optionally register its location to your product's contact list. Select the links below as necessary to create and register the folder, and to scan to it over the network.

[Creating a Shared Network Folder](#)

[Registering Contacts for Email, Network, or FTP Scanning - Control Panel](#)

[Registering Contacts for Network Folder or FTP Scanning - Web Config](#)

[Scanning to a Network Folder or FTP Server](#)

Parent topic: [Starting a Scan](#)

Creating a Shared Network Folder

You can create a shared network folder on your computer or an FTP site and register its location to your product's **Contacts** list.

Note: If you are creating a shared network folder on a Mac, see your Mac documentation for instructions on creating the folder. The instructions here are for Windows.

First make sure you connected your product and computer to the same network.

Note: If you are running a Home version of the Windows operating system, you cannot create a shared folder on your Windows desktop or in the Documents or Pictures folder unless you have created a Home Group Configuration for sharing. You can, however, create a shared folder in the root of the C: drive on your system.

If you want to scan to a folder on an FTP server, contact the FTP server administrator for the server address and authentication access to a shared folder on the server.

1. If you are scanning to a network folder on your computer, do one of the following to check the format of your computer name:
 - **Windows 10 or Windows 8.x:** Hold down the Windows key on your keyboard and press the **X** key. Select **System** from the list that appears. Check the Computer Name or Device Name listed for your computer on the System window.

- **Windows 7:** Click , right-click **Computer**, and select **Properties**. Check the Computer Name listed for your computer on the System window.

Note: The settings in these steps may vary, depending on your version of Windows. See Windows Help for details on your operating system.

2. If the computer's name uses any characters that are not alphanumeric (letters or numbers), do one of the following to change the computer's name:
 - **Windows 10 or 8.x:** Select **Rename this PC** and follow the on-screen prompts.
 - **Windows 7:** Select **Change Settings**, change the computer's name, and click **OK**. (See Windows Help for instructions, if necessary.)

Note: You need to be logged into Windows as an administrator to change the computer's name. After changing the name, restart your computer.

3. Start File Explorer or Windows Explorer.
4. Create a folder on the Windows desktop with a folder name of 12 characters or less; otherwise, your product may not be able to access the folder.

Note: You need to be logged into Windows as an administrator to access the desktop folder and the document folder under each User folder.

5. Right-click the folder you created and select **Properties**.
6. On the **General** tab, deselect the **Read-only** checkbox to allow users to access the folder over the network.
7. Select the **Sharing** tab and click the **Advanced Sharing** button.

Note: You need to be logged into Windows as an administrator to select the **Advanced Sharing** button.

8. On the Advanced Sharing screen, select the **Share this folder** checkbox.
9. Click the **Permissions** button and select the following on the Share Permissions tab:
 - Select **Everyone** under Group or user names.
 - Select the checkbox in the **Allow** column for the **Change** setting.
10. Click **OK** to save the settings, then click **OK** again to close the Advanced Sharing window.

11. Select the **Security** tab and check that the Group or user names list at the top includes the current computer user and the administrators who can now access the folder.
12. Select the **Sharing** tab again and write down the **Network Path** listed under Network File and Folder Sharing at the top. This is the path you will register to your product contacts list so you can select it for network scanning.
13. Click **OK** or **Close**.

Now you can register the folder path to your product contacts list.

Parent topic: [Setting Up and Scanning to a Network Folder or FTP Server](#)

Related tasks

[Registering Contacts for Email, Network, or FTP Scanning - Control Panel](#)

[Registering Contacts for Network Folder or FTP Scanning - Web Config](#)

[Scanning to a Network Folder or FTP Server](#)

Registering Contacts for Email, Network, or FTP Scanning - Control Panel

You can register a list of contacts for scanning to email or to a network folder or FTP server.

1. Press the  home button, if necessary.
2. Select **Settings**.
3. Select **Contacts Manager**. Enter the administrator password, if necessary.
4. Select **Register/Delete**.

You see a screen like this:

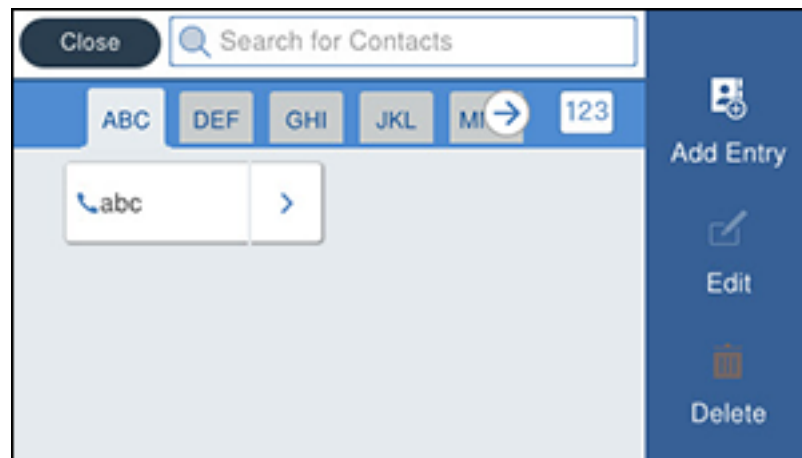

5. Select **Add Entry**.
6. Select **Add Contact**.
7. Do one of the following:
 - To create a contact for scanning to email, select **Email**.
 - To create a location for scanning to a network folder or FTP, select **Network Folder/FTP**.
8. Select the number you want to use for the contact you are adding.
9. Select the **Name** field, use the displayed keyboard to enter the contact name (up to 30 characters), and press **OK**.
10. Select the **Index Word** field, use the displayed keyboard to enter a word to use when searching for an entry (up to 30 characters), and press **OK**. (This field is optional.)
11. Do the following as necessary for your contact:
 - If you want to identify the contact as a frequently used address, select the **Assign to Frequent Use** field and select **On**. This makes it quicker to select the contact when you scan.
 - For an email contact, select the **Email Address** field, use the displayed keyboard to enter the address, and press **OK**.
 - For a network folder or FTP location, select the **Communication Mode** field and select **Network Folder (SMB)** or **FTP**. Then select the **Location** field, use the displayed keyboard to enter the network path to the shared folder, and select **OK**.

Enter the folder path name for the **Location** setting in one of the following formats depending on the **Communication Mode** setting you selected:
 - **SMB**: \\host_name\folder
 - **FTP**: ftp://host_name/folder_name
 - For a network folder or FTP location with a password, select the **User Name** field and use the displayed keyboard to enter the user name. Then select the **Password** field and enter the password.
 - For an FTP location, enter the FTP server port number in the **Port Number** field. If there is a firewall between the product and FTP server, select the **Connection Mode** field and select **Passive Mode**.
12. Select **OK**.

Note: If you need to edit or delete scanning contacts, the procedures are the same as for fax contacts.

Parent topic: [Setting Up and Scanning to a Network Folder or FTP Server](#)

Related tasks

[Scanning to a Network Folder or FTP Server](#)

[Entering Characters on the LCD Screen](#)

Registering Contacts for Network Folder or FTP Scanning - Web Config

You can register a list of contacts for scanning to a network folder or FTP server using Web Config and your computer's internet browser.

Before you begin, print a network status sheet and locate the IP address for your product on the sheet.

Note: These instructions use Internet Explorer as an example browser.

1. Start Internet Explorer on a computer that is using the same network as your product.
2. Type your product's IP address into the address bar and press **Enter**.
3. Click **Continue to this website (not recommended)**.
4. Click **Contacts**.
5. Select the number you want to use for the contact you are adding and click **Edit**.
6. Select **Network Folder (SMB)** or **FTP** as the **Type** setting.
7. Enter the following information for the contact:
 - **Name:** The name to display in your product's contact list.
 - **Index Word:** Enter a word to identify this entry when searching for it (up to 30 characters). This field is optional.
 - **Assign to Frequent Use:** If you want to identify the contact as a frequently used address, select **On**. This makes it quicker to select the contact when you scan.
 - **Save to:** The network path to the shared folder.
Enter the folder path name in one of the following formats depending on the **Type** setting you selected:
 - **SMB:** host_name\folder
 - **FTP:** host_name/folder_name
 - **User Name and Password:** Enter only if you have set up a password on your computer.
 - **Connection Mode:** For FTP locations, select **Passive Mode** if there is a firewall between the product and FTP server.
 - **Port Number:** For FTP locations, enter the port number.

8. Click **Apply**.

After a moment, you see a message telling you that contact registration is complete.

9. Close your web browser.

Parent topic: [Setting Up and Scanning to a Network Folder or FTP Server](#)

Related tasks

[Scanning to a Network Folder or FTP Server](#)

[Printing a Network Status Sheet](#)

Scanning to a Network Folder or FTP Server

You can scan an image and save it to a network folder on your computer or on an FTP server using your product's control panel. You can either enter the folder path directly on the product's control panel or select a folder from the **Contacts** list.

Note: Make sure the date and time are set correctly before using this feature.

1. Place your original on the product for scanning.

Note: To scan a double-sided or multi-page document, place your originals in the ADF.

2. Press the  home button, if necessary.
3. Select **Scan**.

You see a screen like this:

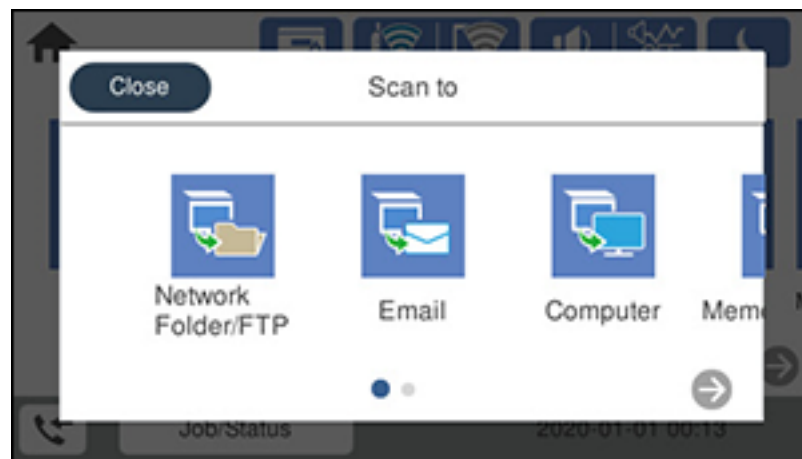

4. Select **Network Folder/FTP**.

You see a screen like this:

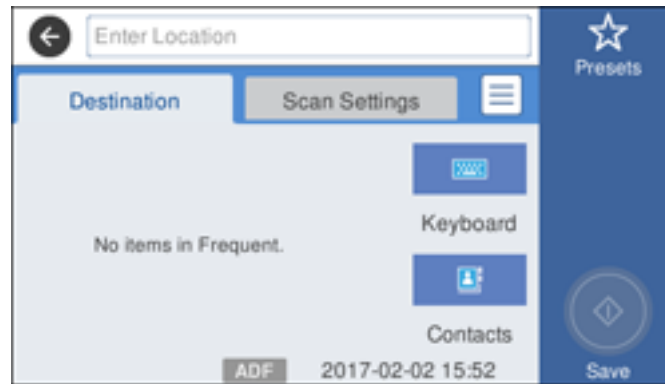

5. Do one of the following:

- Select a frequently used location displayed on the **Destination** tab, if you created any.
- Select **Contacts** and choose a saved location from the **Contacts** list.
- Select **Keyboard**, then select the **Communication Mode** field and select **Network Folder (SMB)** or **FTP**. Then select the **Location** field and enter the folder location, and press **OK**.

Enter the folder path name for the **Location** setting in one of the following formats depending on the **Communication Mode** setting you selected:

- **SMB:** \\host_name\folder
- **FTP:** ftp://host_name/folder_name
- For a network folder or FTP location with a password, select the **User Name** field and use the displayed keyboard to enter the user name. Then select the **Password** field and enter the password.
- For an FTP location, enter the FTP server port number in the **Port Number** field. If there is a firewall between the product and FTP server, select the **Connection Mode** field and select **Passive Mode**.

6. Select **Scan Settings**.

7. Select **File Format** to choose the file format for your scan.

8. If necessary, scroll down and change the **File Name** setting listed under the File Settings heading.

9. Select any additional scan settings as necessary.
10. Select **Presets** to save your scan settings.
11. Select **Save**.

Your product scans your original and saves it in the selected location.

Parent topic: [Setting Up and Scanning to a Network Folder or FTP Server](#)

Related references

[Control Panel Scanning Options](#)

Related tasks

[Selecting the Date and Time](#)

[Entering Characters on the LCD Screen](#)

[Registering Contacts for Email, Network, or FTP Scanning - Control Panel](#)

[Registering Contacts for Network Folder or FTP Scanning - Web Config](#)



Related topics

[Placing Originals on the Product](#)

Starting a Scan Using the Epson Scan 2 Icon

You can start the Epson Scan 2 program to select scan settings, scan, and save the scanned image to a file.

Note: If you are using your Epson product with the Windows 10 S operating system, you cannot use the software described in this section. You also cannot download and install any Epson product software from the Epson website for use with Windows 10 S; you must obtain software only from the Windows Store.

- **Windows 10:** Click  and select **EPSON > Epson Scan 2**.
- **Windows 8.x:** Navigate to the **Apps** screen and select **Epson Scan 2**.
- **Windows (other versions):** Click  or **Start**, and select **All Programs** or **Programs**. Select **EPSON > Epson Scan 2 > Epson Scan 2**.
- **Mac:** Open the **Applications** folder, open the **Epson Software** folder, and select **Epson Scan 2**.

You see an Epson Scan 2 window like this:

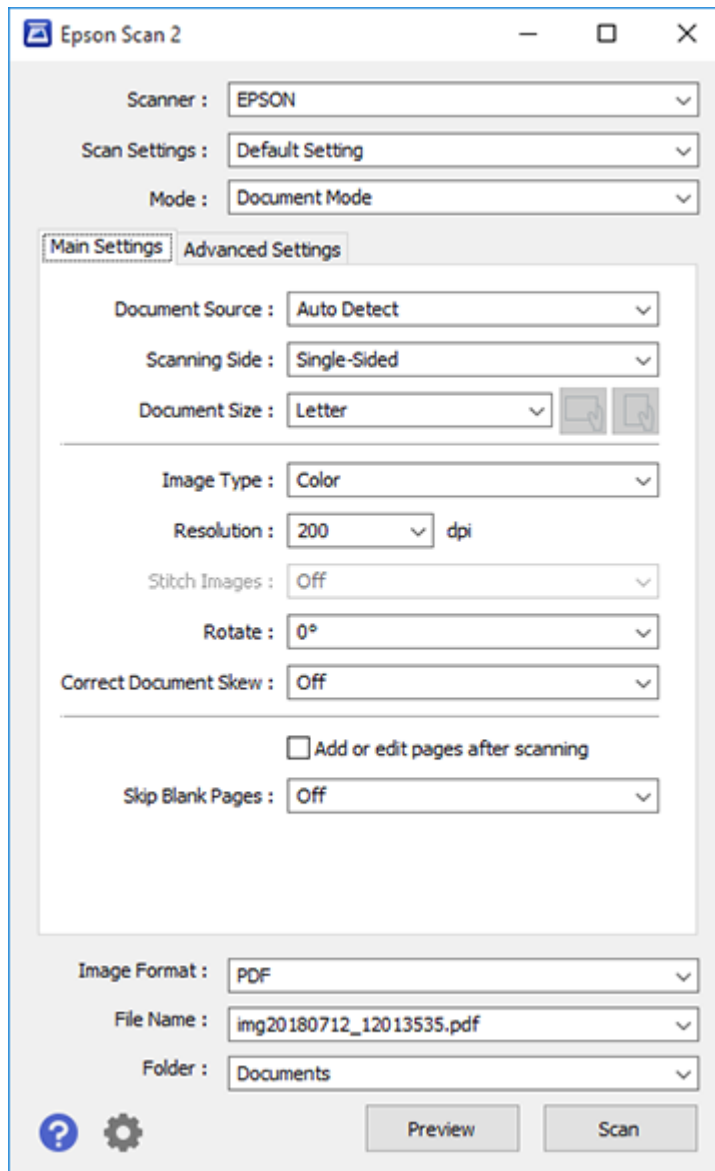

Parent topic: [Starting a Scan](#)

Starting a Scan from a Scanning Program

You can start Epson Scan 2 from a TWAIN-compliant scanning program to select scan settings, scan, and open the scanned image in the program.

Note: If you are using your Epson product with the Windows 10 S operating system, you cannot use the software described in this section. You also cannot download and install any Epson product software from the Epson website for use with Windows 10 S; you must obtain software only from the Windows Store.

1. Open your scanning program and select its scanning option. (See your scanning program help for instructions.)
2. Select your product.

Note: In certain programs, you may need to select your product as the "source" first. If you see a **Select Source** option, choose it and select your product. With Windows, do not select a **WIA** option for your product; not all scan functions will be available.

You see an Epson Scan 2 window like this:

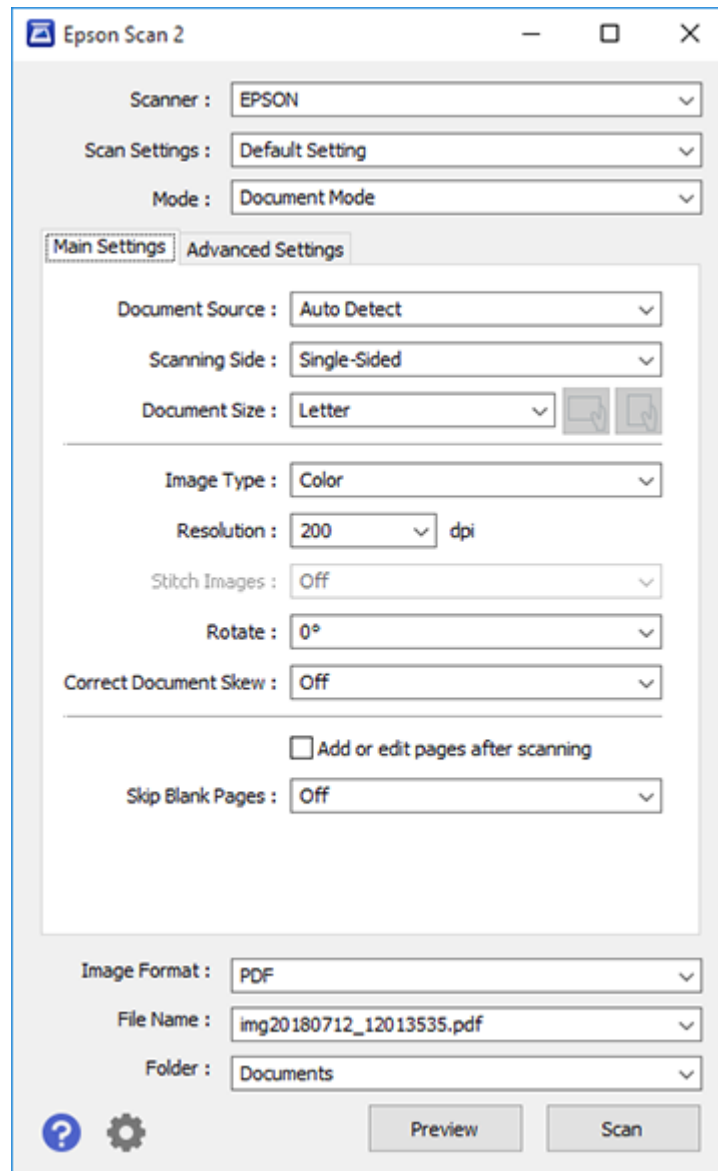

Parent topic: [Starting a Scan](#)

Starting a Scan from a Smartphone or Tablet

You can use the Epson Smart Panel app to scan from a network scanner to an iOS or Android device over a direct Wi-Fi connection.

1. Download the Epson Smart Panel app from your device's app store or from Epson's website. See the link below.
2. Place your original on the product for scanning.
3. Open the Epson Smart Panel app and select a scan menu on the home screen.
4. Follow the on-screen instructions to scan and save your original.

Parent topic: [Starting a Scan](#)

Related tasks



[Using the Epson Smart Panel Mobile App](#)

[Setting Up Wireless Printing from a Smart Device Using Epson Smart Panel](#)

Scanning a Document in Epson ScanSmart

You can scan and review documents and photos in Epson ScanSmart.

Note: The images in this guide show Windows screens. Mac screens may be slightly different. Depending on your product model and software version, not all options may be available.

1. Load your original into the product.
2. Open Epson ScanSmart on your computer. Do one of the following:
 - **Windows 10:** Click  > **Epson Software** > **Epson ScanSmart**.
 - **Windows 8.x:** Navigate to the **Apps** screen and select **Epson ScanSmart**.
 - **Windows (other versions):** Click  or **Start**, and select **All Programs** or **Programs**. Select **Epson Software** > **Epson ScanSmart**.
 - **Mac:** Open the **Applications** folder, open the **Epson Software** folder, and select **Epson ScanSmart**.

You see a screen like this:

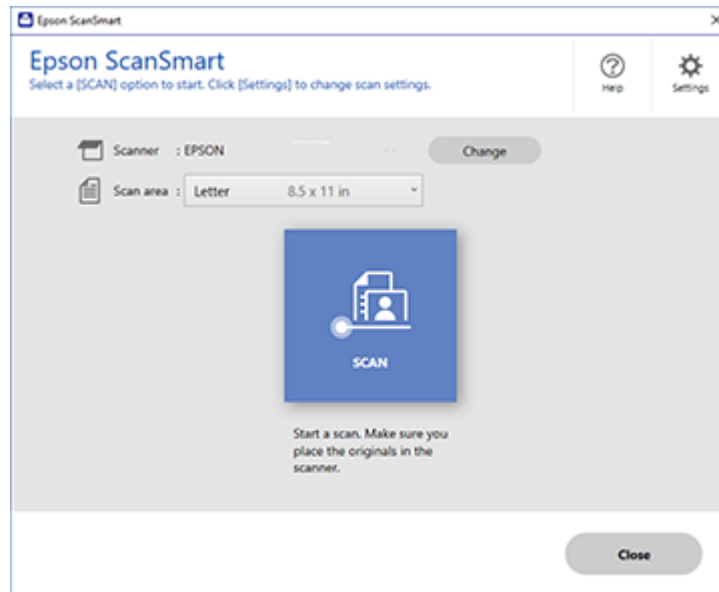

3. Select an option for the **Scan area** setting, if necessary.

Note: The **Scan area** setting limits the scan area to a selected size starting at the placement arrow on the scanner bed. It does not scale the image to the selected size.

4. Select **SCAN**.

The original is scanned. When scanning is complete, you see a screen like this:

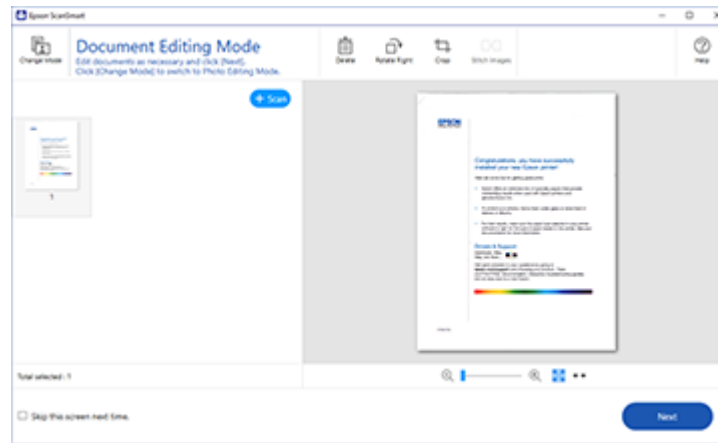

5. You can review, edit, or reorder the scanned images as follows:
 - Select **+ Scan** to scan more originals.
 - Select **Delete** to delete selected scanned images.
 - Select **Rotate Right** to rotate each scanned image.
 - Select **Crop** to crop the selected image.
 - Control-click two images, select **Stitch Images**, and follow the on-screen instructions to combine them into a single image.
6. If Photo Mode is automatically detected, the following enhancement options are available:
 - **Auto Color Enhancement**: automatically adjusts the brightness, contrast, and saturation of your photos
 - **Restore Faded Colors**: restores the colors in faded photos automatically
 - **Remove Red Eye**: automatically removes the red-eye effect from your photos
 - **Auto Cropping**: automatically crops the scanned image edges
7. When you finish reviewing and editing the scanned images, click **Next**.

You see a screen like this:

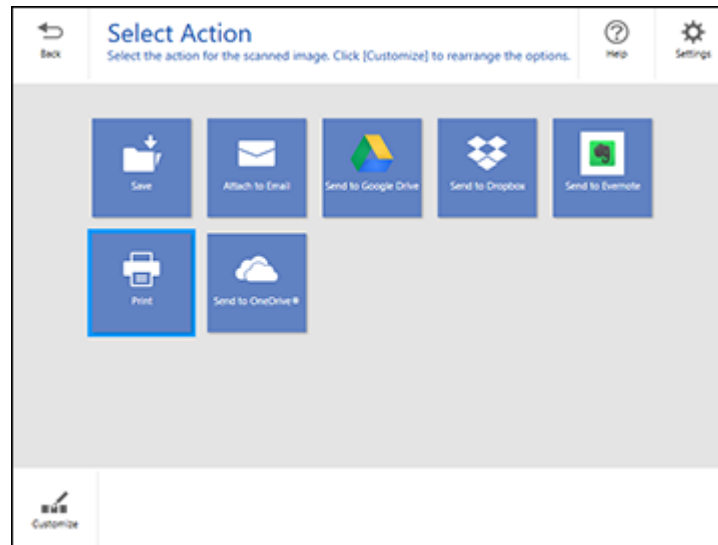

8. Select an option to save, send, or print the scanned images. See the links below.

[Saving a Scan](#)

[Attaching a Scan to Email](#)

[Sending a Scan to a Cloud Service](#)

[Printing a Scan](#)

Parent topic: [Scanning](#)

Saving a Scan

You can save a scanned image to your computer in a variety of formats.

1. Make sure your originals are scanned and reviewed. See the link below.
2. In the **Select Action** window, click **Save**.

You see a screen like this:

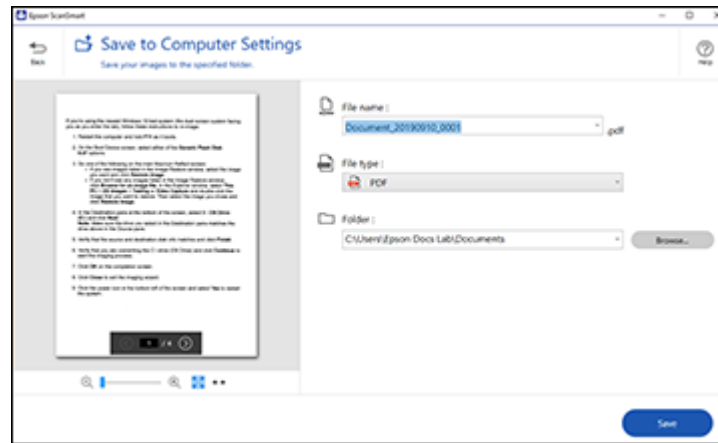

3. Change the settings as follows:
 - The document type and scan date for the file name are automatically detected. You can change them as necessary.
 - You can save the scanned image in a variety of formats. If you select Searchable PDF as the **File type** setting, you can select the OCR (Optical Character Recognition) language.
 - Select the folder on your computer in which to save the file.
4. Click **Save**.

Parent topic: [Scanning a Document in Epson ScanSmart](#)

Attaching a Scan to Email

You can attach a scanned image to an email as a file attachment.

Note: Your email app and account settings should be configured before scanning. You must install a MAPI-type email program such as Outlook Express, Windows Live Mail, Entourage, or Mac Mail. Attach to Email only supports 32-bit MAPI-compatible mail apps. Web-based email services such as Gmail are not supported. If you see an error message, your email app may not be compatible and you will need to save the scans and manually attach the file to an email.

1. Make sure your originals are scanned and reviewed. See the link below.

2. In the **Select Action** window, click **Attach to Email**.

You see a screen like this:

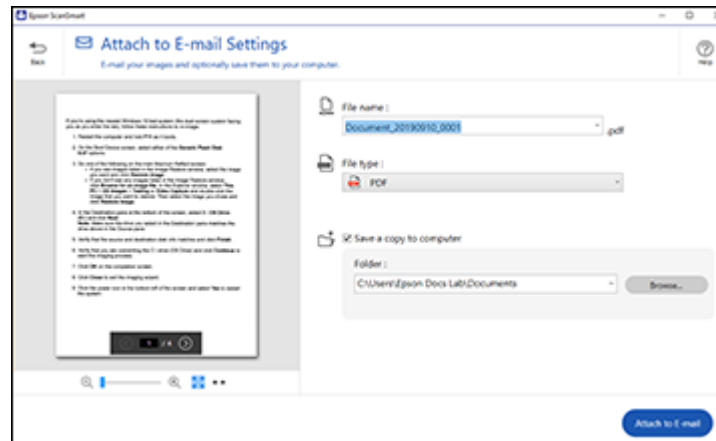

3. Change the settings as follows:
 - The document type and scan date for the file name are automatically detected. You can change them as necessary.
 - You can save the scanned image in a variety of formats. If you select Searchable PDF as the **File type** setting, you can select the OCR (Optical Character Recognition) language.
 - If you also want to save a copy of the scanned image to your computer, make sure the checkbox is selected and select the folder on your computer in which to save the file.
4. Click **Attach to E-mail**.

Your email program opens with the file attached to a new email.

Parent topic: [Scanning a Document in Epson ScanSmart](#)

Sending a Scan to a Cloud Service

You can upload scanned images to a cloud service.

1. Make sure your originals are scanned and reviewed. See the link below.
2. In the **Select Action** window, click one of the cloud service send options.

You see a screen like this:

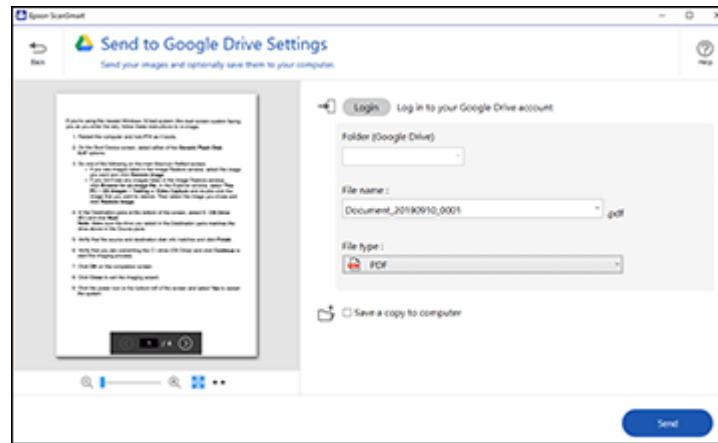

3. Log in to your account.

Note: You may need to allow Epson ScanSmart access to your account. The first time you log in, you may be prompted to enter an authentication code.

4. Change the settings as follows:
 - Select the folder in your account where you want to send the document.
 - The document type and scan date for the file name are automatically detected. You can change them as necessary.
 - You can save the scanned image in a variety of formats. If you select Searchable PDF as the **File type** setting, you can select the OCR (Optical Character Recognition) language.
 - If you also want to save a copy of the scanned image to your computer, click the checkbox.
5. Click **Send**.

Parent topic: [Scanning a Document in Epson ScanSmart](#)

Printing a Scan

You can print your scanned image and save the scanned file to your computer.

Note: Printing scanned images is available only with Epson printers. If you do not have an Epson printer, save the file and print it from an application that can open the file.

1. Make sure your originals are scanned and reviewed. See the link below.
2. In the **Select Action** window, click **Print**.

You see a screen like this:

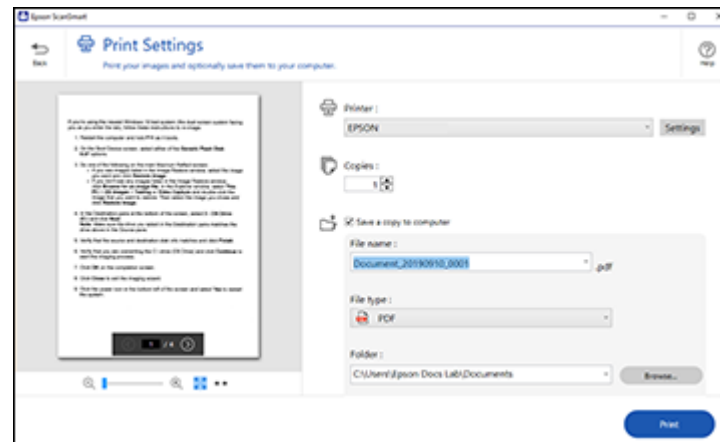

3. Change the settings as follows:
 - Select the Epson printer and change the print settings, if necessary.
 - Select the number of copies you want to print.
 - If you also want to save a copy of the scanned image to your computer, click the checkbox.
 - The document type and scan date for the file name are automatically detected. You can change them as necessary.
 - You can save the scanned image in a variety of formats. If you select Searchable PDF as the **File type** setting, you can select the OCR (Optical Character Recognition) language.
 - Select the folder on your computer in which to save the file.
4. Click **Print**.

Parent topic: [Scanning a Document in Epson ScanSmart](#)

Selecting Epson ScanSmart Settings

After starting Epson ScanSmart, you can change various scanning settings.

[Changing the Epson Product](#)

[Changing the Scan Settings](#)

[Changing the File Name Settings](#)

[Changing the Save Settings](#)

[Customizing Action Icons](#)

Parent topic: [Scanning](#)

Changing the Epson Product

If you are using more than one Epson product with Epson ScanSmart, you can change the product that you are using with your computer.

Note: A product connected to your computer via USB takes priority over a product with a Wi-Fi connection.

1. On the main screen, click **Change**.

You see a screen like this:

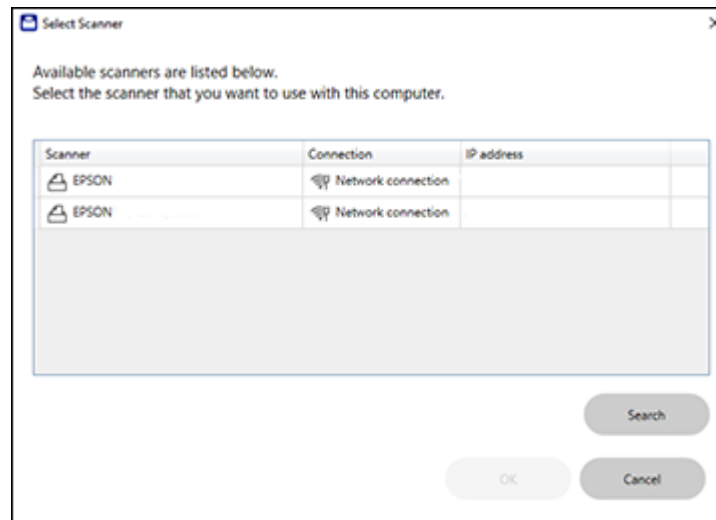

2. Select the Epson product you want to use with your computer and click **OK**.

Parent topic: [Selecting Epson ScanSmart Settings](#)

Changing the Scan Settings

You can change detailed scan settings such as the resolution, document size, and more.

Note: If you select **Auto Mode**, you cannot change the scan settings.

1. Click the  **Settings** button.

You see a screen like this:

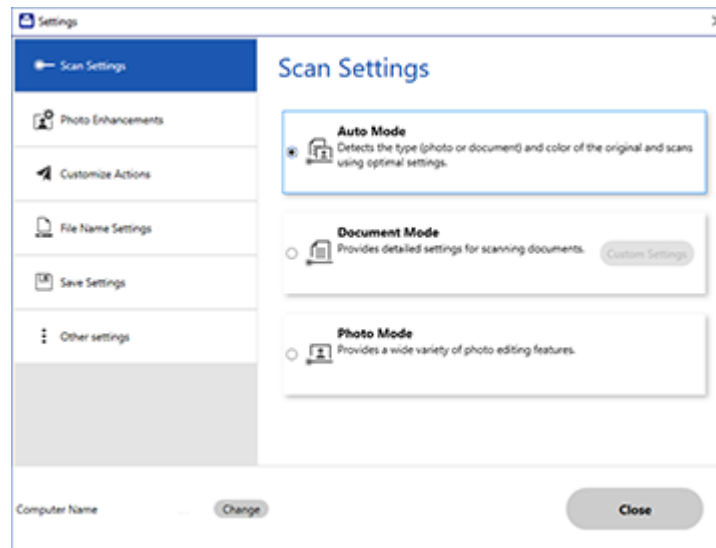

2. Do one of the following:

- To change Document Mode settings, select **Document Mode > Custom Settings**.
- To change Photo Mode settings, select **Photo Mode** and click **Close**. When you start a scan, you will be prompted to select scan settings.

You see a screen like this:

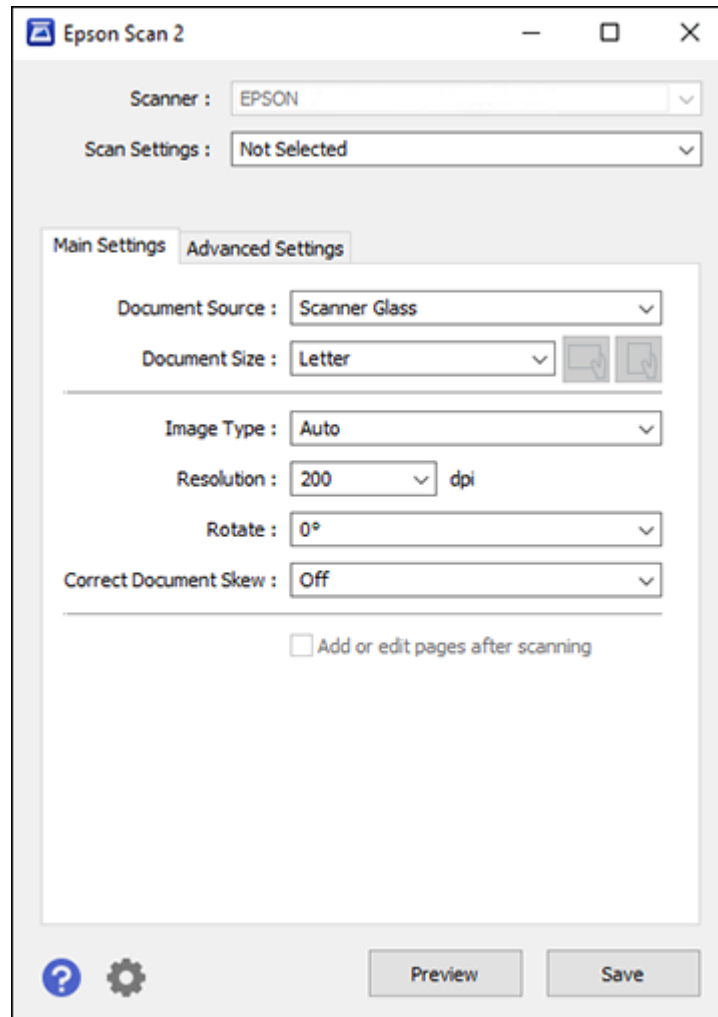

3. Change the settings as necessary and click **Save**.

Parent topic: [Selecting Epson ScanSmart Settings](#)

Related references

[Additional Scanning Settings - Main Settings Tab](#)

Changing the File Name Settings

You can change the default file naming method for your scans.

1. Click the  **Settings** button.

You see a screen like this:

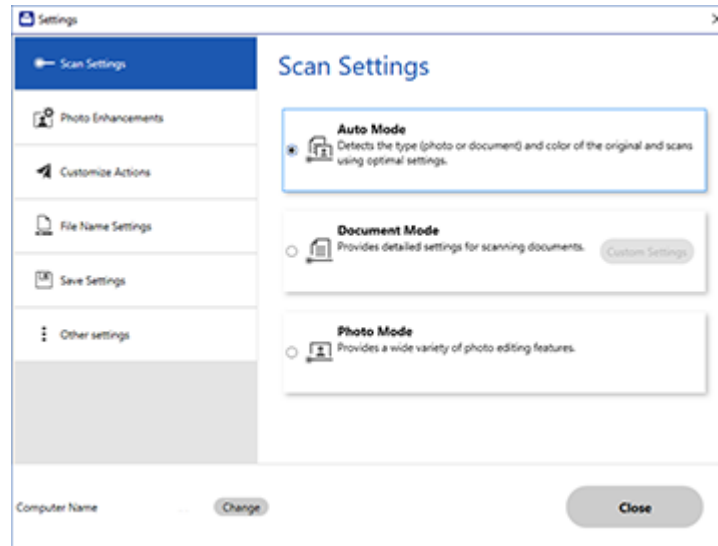

2. Click the **File Name Settings** tab.

You see a screen like this:

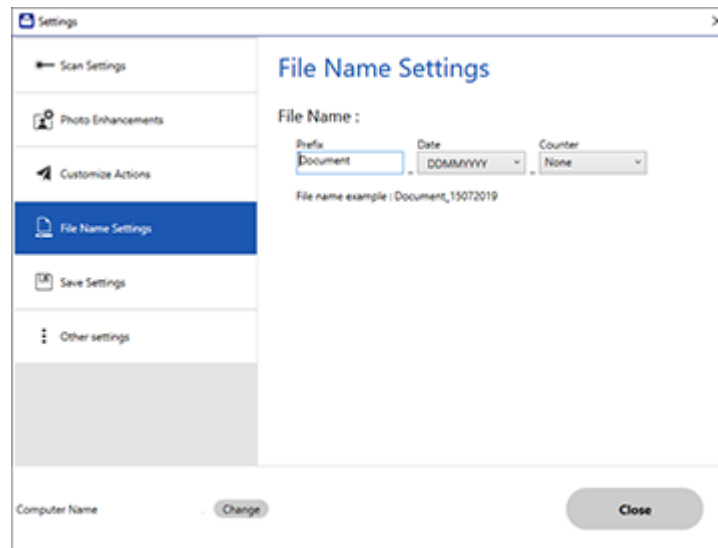

3. Change the settings as necessary:
 - Enter a prefix for the file name.
 - Select the date format.
 - Select a numbering format as the counter format.

4. Click **Close**.

Parent topic: [Selecting Epson ScanSmart Settings](#)

Changing the Save Settings

You can change the file type options for saving your scans.

1. Click the  **Settings** button.

You see a screen like this:

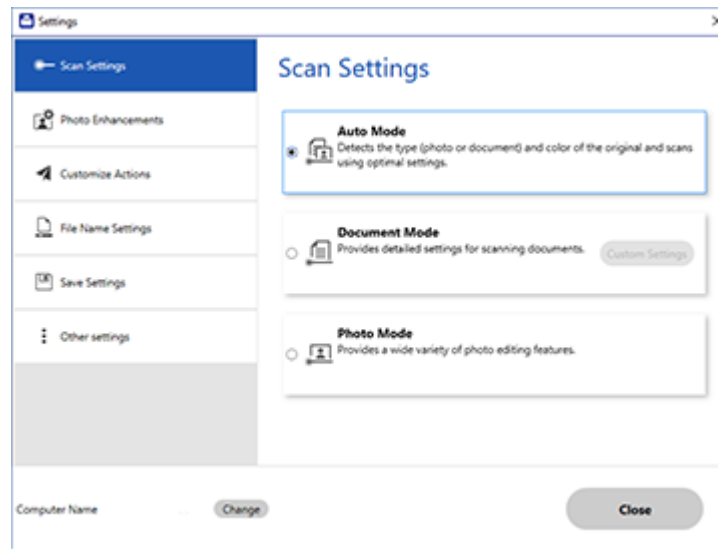

2. Click the **Save Settings** tab.

You see a screen like this:

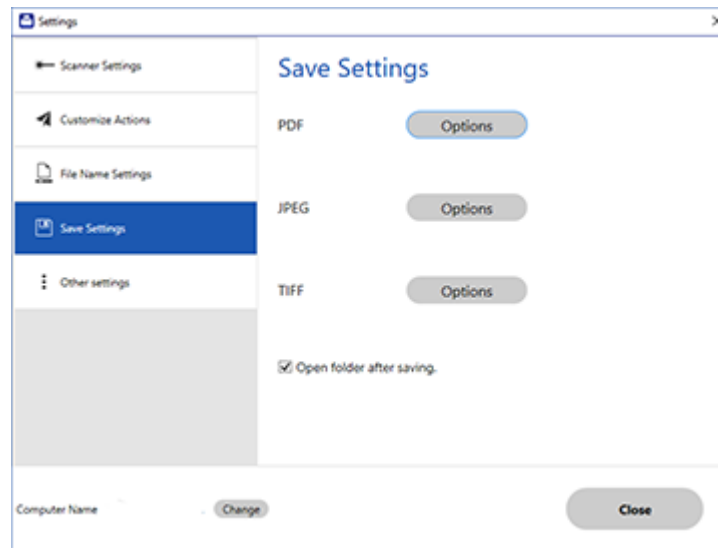

3. Click **Options** for a file format and change the settings as necessary.
4. Click **Open folder after saving** to open the file folder after a file is saved.
5. Click **Close**.

[Save Settings](#)

Parent topic: [Selecting Epson ScanSmart Settings](#)

Save Settings

You can change the settings for how scanned images are saved.

PDF Options

Setting	Options	Description
General	Generate PDF/A File	Creates a PDF that conforms to PDF/A-1 standards
	Create file with all pages	Saves all pages as one file
	Compression Level	Selects the compression level for color or grayscale images

JPEG Options

Setting	Options	Description
Image Quality Options	—	Sets a compression level by moving a slider or entering a value. File size increases the higher the resolution is.
Encoding (Windows only)	Standard	Images load from top to bottom in a web browser. It takes longer to load the entire image.
	Progressive	Images first load completely at low resolution and then adjust to high resolution in a web browser
Embed ICC Profile (Windows only)	—	Allows you to add ICC profiles to the image

TIFF Options

Setting	Options	Description
Byte Order	Windows Macintosh	Specifies the operating system where the scanned image will be used
Compression (Windows only)	—	Specifies the compression format and level for Color/Grayscale and B&W images. File size increases with higher quality.
Embed ICC Profile (Windows only)	—	Allows you to add ICC profiles to the image

Parent topic: [Changing the Save Settings](#)

Customizing Action Icons

You can customize which scan action icons appear on the **Select Action** screen.

Note: You can also customize them by clicking the **Customize** icon on the **Select Action** screen.

1. Click the  **Settings** button.

You see a screen like this:

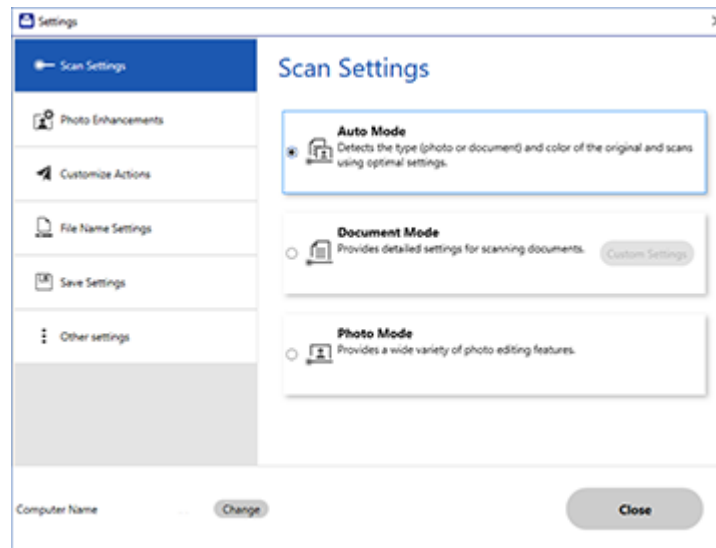

2. Click the **Customize Actions** tab.

You see a screen like this:

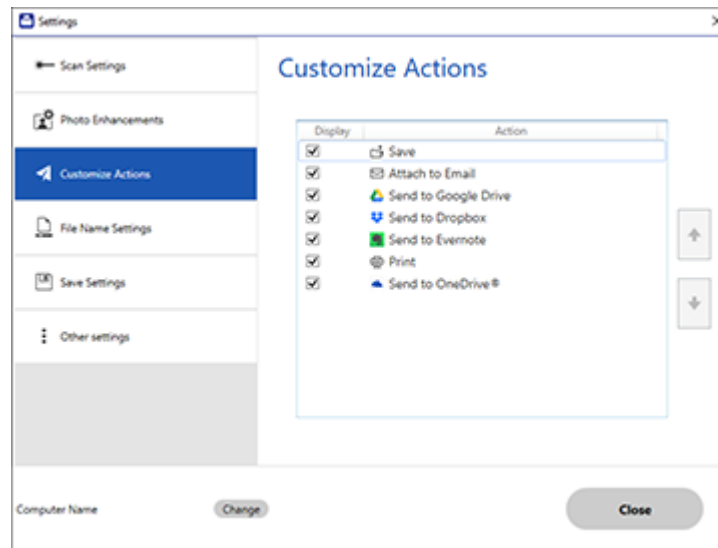

3. Choose which action icons to display by selecting or deselecting each checkbox. Click the arrow icons to move the icons up or down in the display order you want.
4. Click **Close**.

Parent topic: [Selecting Epson ScanSmart Settings](#)

Scanning in Epson Scan 2

Epson Scan 2 gives you access to basic and advanced scanning features. You can scan your document and save the scanned image in various file formats in your operating system's Documents or My Documents folder, or open it in your scanning program. You can preview the scanned image and select or change settings as necessary.

Note: If you are using your Epson product with the Windows 10 S operating system, you cannot use the software described in this section. You also cannot download and install any Epson product software from the Epson website for use with Windows 10 S; you must obtain software only from the Windows Store.

1. Start Epson Scan 2.

You see this window:

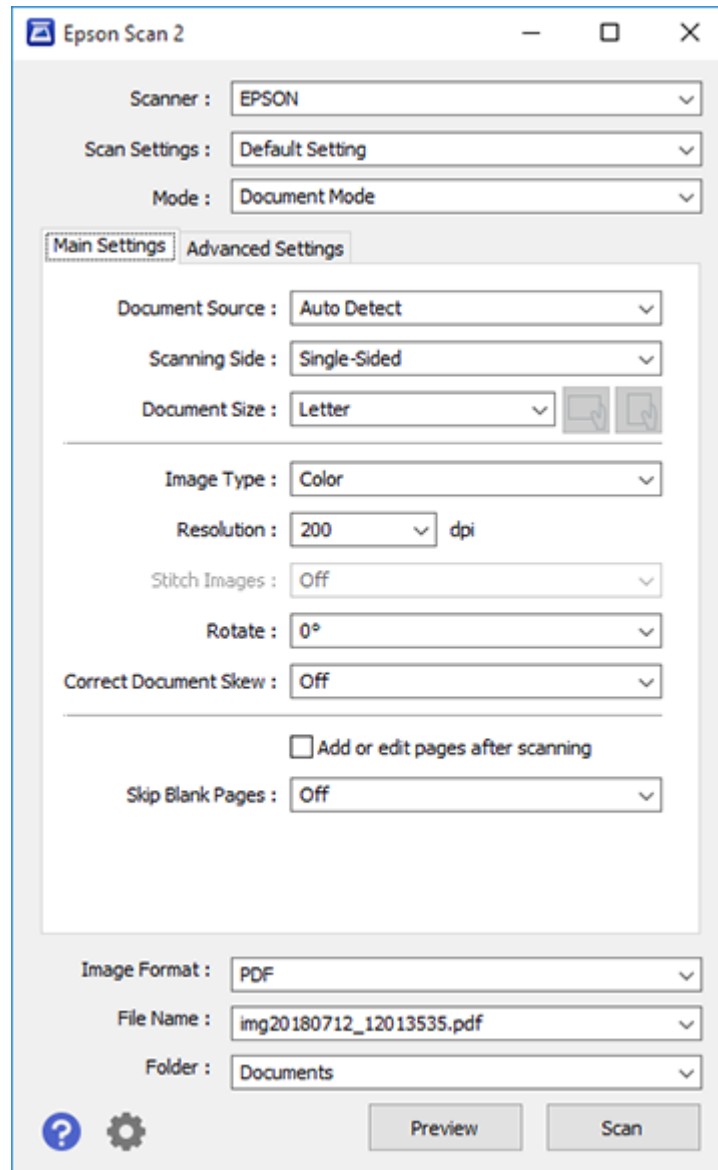

2. Select the **Mode** setting that matches the type of original you are scanning.
3. Select the **Document Source** setting that matches where you placed your original, or select **Auto Detect** to have Epson Scan 2 automatically detect the source.
4. Select the **Scanning Side** setting if you are scanning from the ADF.
5. Select the **Document Size** setting that matches the size of your original. You can select **Customize** to enter a custom size, if necessary.
6. Select the image type of your original and how you want it scanned as the **Image Type** setting.
7. Select the **Resolution** setting you want to use for your scan.
8. Select the **Rotate** setting to rotate the scanned image.
9. Select the **Correct Document Skew** setting to correct skewed originals, image contents, or both.
10. Click the **Preview** button.

Epson Scan 2 previews your original and displays the results in the Epson Scan 2 window.

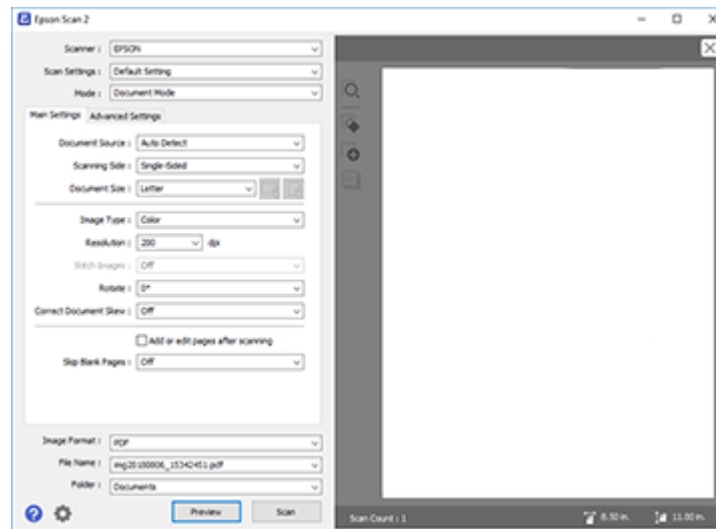

11. Reinsert your original into the ADF, if necessary.
12. Do one of the following:
 - If you're scanning in Document Mode, select any of the additional settings that you want to use on the Main Settings tab.

- If you're scanning in Photo Mode, select the **Color Management** and **Thumbnail Options** settings as necessary.
13. Click the **Advanced Settings** tab and select any settings that you want to use.
 14. Select the format in which you want to save your scanned file as the **Image Format** setting. If necessary, select **Options** and select any desired format options.
 15. Enter the file name for your scanned file in the **File Name** field. If necessary, select **Settings** to modify the file name settings.
 16. Select the location in which you want to save your scanned file as the **Folder** setting. If necessary, select **Select** to create a new folder.
 17. Click **Scan**.

The product scans your original and saves the scanned file in the location you specified.

[Additional Scanning Settings - Main Settings Tab](#)

[Additional Scanning Settings - Advanced Settings Tab](#)

[Saving Scanned Documents as a Searchable PDF Using Epson Scan 2](#)

[Image Format Options](#)

[Scan Resolution Guidelines](#)

Parent topic: [Scanning](#)

Additional Scanning Settings - Main Settings Tab

You can select these additional scanning settings on the Epson Scan 2 Main Settings tab. Not all adjustment settings may be available, depending on other settings you have chosen.

Stitch Images

When scanning double-sided originals, lets you lay out images from both sides of the original onto one scanned page.

Rotate

Rotates the original image clockwise to the desired angle before scanning it. Select **Auto** to allow your product to automatically rotate the image based on the orientation of the text (may take longer to scan).

Correct Document Skew

Corrects skewed originals, image contents, or both.

Add or edit pages after scanning

Lets you add, remove, or edit the pages in a scan, including rotating pages and changing the page order.

Note: To save multiple pages in a single file, you must select a file format that supports multiple pages such as **PDF** or **Multi-TIFF**. If you select another file format, each scanned image or page is saved as a separate file.

Skip Blank Pages

If the scanner detects marks from the other side of a blank page and adds the marks to the scanned image, adjust this setting to prevent this.

Parent topic: [Scanning in Epson Scan 2](#)

Additional Scanning Settings - Advanced Settings Tab

You can select these additional scanning settings on the Epson Scan 2 Advanced Settings tab. Not all adjustment settings may be available, depending on other settings you have chosen.

Remove Background

Removes the background of the originals.

Text Enhancement

Sharpens the appearance of letters in text documents.

Auto Area Segmentation

Makes black and white images clearer and text recognition more accurate by separating the text from the graphics.

Threshold

Adjusts the level at which black areas in text and line art are delineated, improving text recognition in OCR (Optical Character Recognition) programs.

Color Enhance

Enhances the shades of the color you select in the scanned image. This setting is available only if you select **Grayscale** or **Black & White** as the Image Type setting.

Brightness

Adjusts the overall lightness and darkness of the scanned image.

Contrast

Adjusts the difference between the light and dark areas of the overall scanned image.

Saturation

Adjusts the density of colors in the overall image.

Gamma

Adjusts the midtone density of the scanned image.

Unsharp Mask

Makes the edges of certain image areas clearer. Turn off this option to leave softer edges.

Descreening

Removes the ripple pattern that might appear in subtly shaded image areas, such as skin tones. This option improves results when scanning magazines or newspapers. (The results of descreening do not appear in the preview image, only in your scanned image.)

Color Restoration

Corrects color in faded images (when scanning in Photo Mode).

Backlight Correction

Lightens darkly backlit images (when scanning in Photo Mode).

Edge Fill

Corrects shadowing around the edges of the image by filling the shadows with black or white.

Correct Document Skew

Corrects skewed originals, image contents, or both.

Parent topic: [Scanning in Epson Scan 2](#)

Saving Scanned Documents as a Searchable PDF Using Epson Scan 2

You can scan a document and save the text in a searchable PDF. In a searchable PDF, text is recognized using Optical Character Recognition (OCR) and then embedded in the scanned original.

Note: The required Epson Scan 2 OCR Component Pro is installed automatically when you install your product software as instructed on the *Start Here* sheet. If you install your scanner software programs individually, be sure to also install this component using the Epson Software Updater if you want to perform OCR.

1. Load your original in the product for scanning.
2. Start Epson Scan 2.
3. Select your scan settings.
4. Click **Preview** and adjust the area you want to scan, if necessary.
5. If you are using the ADF, reload the ejected original.
6. Select **Searchable PDF** as the Image Format setting.
7. Select **Options** from the Image Format list.

You see this window:

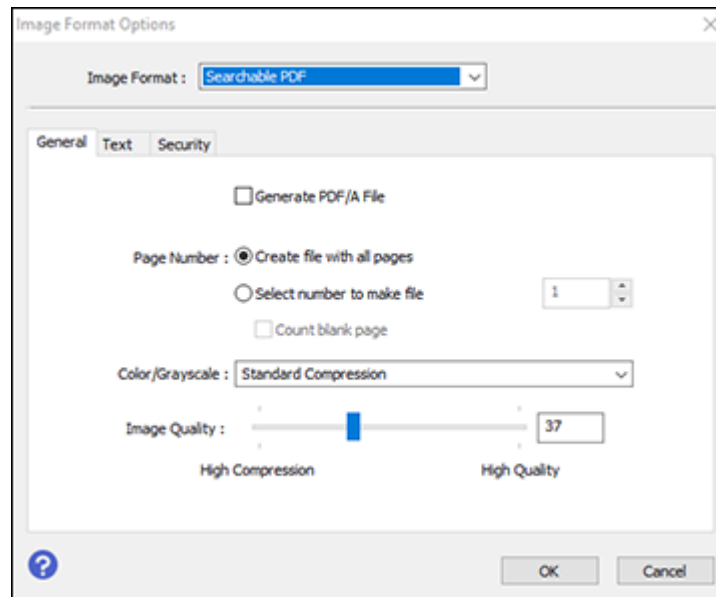

8. Select any of the options on the General tab.
9. Select the **Text** tab.
10. Make sure the language used in the document text is selected as the **Text Language** setting.
11. Select the **Security** tab if you want to add a password to the PDF or protect printing or editing properties.
12. Click **OK**.
13. Confirm the **File Name** setting and select a **Folder** setting for your document.
14. Click **Scan**.

The scanned image is saved as a searchable PDF.

Parent topic: [Scanning in Epson Scan 2](#)

Image Format Options

You can select different image formats and related options. For details on available options, click the ? icon on the Epson Scan 2 Image Format Options window. Not all image formats have options.

BITMAP (*.bmp)

A standard image file format for most Windows programs.

JPEG (*.jpg)

An image format that lets you highly compress image data. However, the higher the compression, the lower the image quality. (The TIFF format is recommended when you need to modify or retouch your scanned image.)

PNG (*.png)

An image format that does not lose quality during editing.

TIFF (*.tif)

A file format created for exchanging data between many programs, such as graphic and DTP software.

Multi-TIFF (*.tif)

A TIFF file format when multiple pages are saved to the same file, allowing you to edit the images using a compatible program.

PDF (*.pdf)

A document format that is readable by Windows and Mac systems using Adobe Reader, Acrobat, or other programs. You can save multi-page documents in one PDF file.

Searchable PDF (*.pdf)

A document format that is readable by Windows and Mac systems using Adobe Reader, Acrobat, or other programs. You can save multi-page documents in one PDF file. Recognized text in the scanned document can be searched.

Parent topic: [Scanning in Epson Scan 2](#)

Scan Resolution Guidelines

The **Resolution** setting, measured in dpi (dots per inch), controls the amount of detail captured in your scans. Increasing the resolution raises the amount of detail captured but comes with the following disadvantages:

- Larger file sizes
- It takes longer to scan your originals, send/receive your scans by email or fax, and to print your scans
- The image may become too large to fit on your display or print on paper

If you plan to enlarge a scanned image so you can print it at a larger size, you may need to increase the resolution from the default resolution set by Epson Scan 2. Follow these guidelines to determine the resolution setting you need:

- You will scan the image at its original size but enlarge it later in an image-editing program.

Increase the Epson Scan 2 Resolution setting in your scan. Increase the resolution by the same amount you will increase the image size to retain a high image quality. For example, if the resolution is 300 dpi (dots per inch) and you will double the image size later, change the Resolution setting to 600 dpi.

- You will scan the image at 100% or a smaller size.

Select the Epson Scan 2 Resolution setting based on how you will use the scanned image:

- Email/view on a computer screen/post on the web: 96 to 200 dpi
- Print/fax/convert to editable text (OCR)/create searchable PDF: 200 to 300 dpi

Parent topic: [Scanning in Epson Scan 2](#)

Faxing

See these sections to fax using your product.

Note: This product allows you to store names, telephone numbers, and fax data in its memory even when the power is turned off. Make sure you restore all of the default settings if you give away or dispose of the product. This will erase all of your network settings and fax data.

[Connecting a Telephone or Answering Machine](#)

[Setting Up Fax Features](#)

[Setting Up Contacts and Contact Groups](#)

[Sending Faxes](#)

[Receiving Faxes](#)

[Checking Fax Status](#)

[Printing Fax Reports](#)

Connecting a Telephone or Answering Machine

You must connect your product to a telephone wall jack to send or receive faxes. If you want to use the same telephone line to receive calls, you can connect a telephone or answering machine to your product using an additional phone cable.

Note: If you do not connect a telephone to your product, make sure Receive Mode is set to **Auto**. Otherwise, you cannot receive faxes.

1. Connect a phone cable to your telephone wall jack and to the **LINE** port on your product.

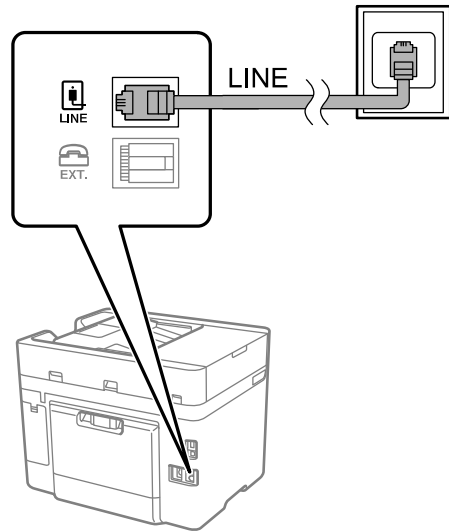

Note: If you have a DSL or ISDN connection, you must connect the appropriate DSL filter, or ISDN terminal adapter or router to the wall jack to be able to use the line for faxing or voice calls using your product. Contact your DSL or ISDN provider for the necessary equipment.

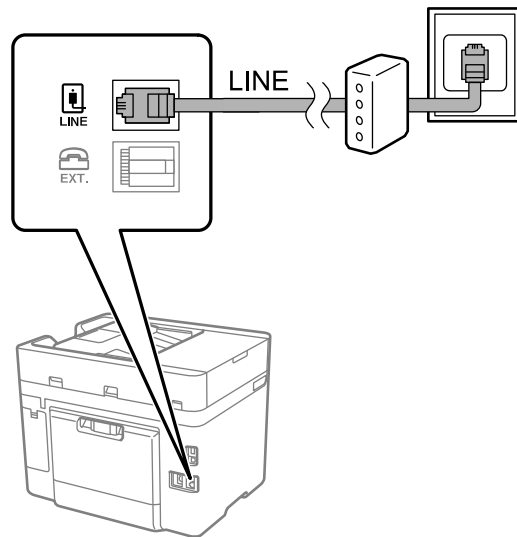

2. If you are connecting a telephone or answering machine to your product using a second phone cable, remove the cap from the **EXT** port on your product.

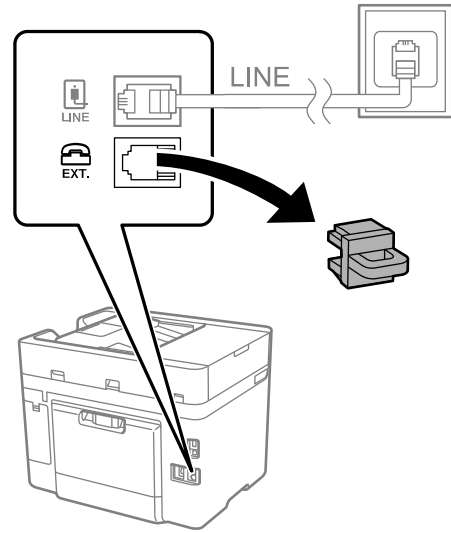

3. Connect a second phone cable to your telephone or answering machine and to the **EXT** port on your product.

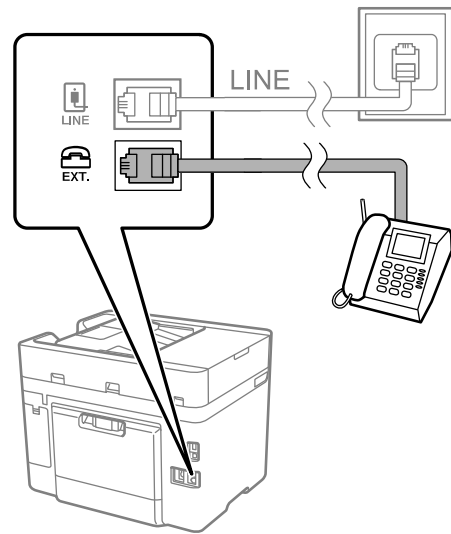

Note: If you connect an answering machine and Receive Mode is set to **Auto**, set the number of rings before your product answers a call to a number that is higher than your answering machine's setting for the number of rings.

Any phone or answering machine must be connected to the **EXT** port for your product to detect an incoming fax call when the phone is picked up. Epson cannot guarantee compatibility with VoIP, cable phone systems, or fiberoptic digital services such as FIOS.

Parent topic: [Faxing](#)

Related tasks

[Receiving Faxes Automatically](#)

Setting Up Fax Features

Before faxing with your product, set up your fax header and select the fax features you want to use.

Note: If you leave your product unplugged for a long period of time, you may need to reset the date and time settings for faxes.

[Setting Up Basic Fax Features](#)

[Selecting Advanced Fax Settings](#)

[Setting Up the Fax Utility - Windows](#)

[Setting Up Fax Features Using the Fax Utility - Mac](#)

Parent topic: [Faxing](#)

Setting Up Basic Fax Features

See these sections to select the basic settings you need to use the product's fax features.

[Using the Fax Setup Wizard](#)

[Selecting the Line Type](#)

[Setting the Number of Rings to Answer](#)

Parent topic: [Setting Up Fax Features](#)

Using the Fax Setup Wizard

You can setup the product's basic fax settings using the Fax Setting Wizard. This wizard is automatically displayed when the product is turned on for the first time. You can also change these settings individually from the Fax Settings menu.

Note: These settings can be locked by an administrator. If you cannot access or change these setting, contact your administrator for assistance.

1. Press the  home button, if necessary.
2. Select **Settings > General Settings > Fax Settings > Fax Setting Wizard.**

You see a screen like this:



3. Select **Proceed.**
4. On the Fax Header screen, use the displayed keypad to enter the sender name for your fax source, such as your name or a business name. You can enter up to 40 characters. Select **OK** when you are done.
5. On the Your Phone Number screen, use the displayed keypad to enter your fax number, up to 20 characters. Select **OK** when you are done.

Note: The name and phone number in the fax header identifies the source of the faxes you send.

6. On the Distinctive Ring Setting screen, do one of the following:
 - If you have subscribed to a distinctive ring service from your telephone company, select **Proceed.** Select the ring pattern to be used for incoming faxes or select **All.** Go to the next step.

- If you do not have a distinctive ring service, select **Skip** and go to step 9.

Note: Distinctive ring services allows you to have several phone numbers on one phone line. Each number is assigned a different ring pattern. You can use one number for voice calls and another for fax calls. Select the ring pattern assigned to fax calls in the DRD Setting. If you select a ring pattern other than **All**, Receive Mode is automatically set to **Auto**.

7. On the Proceed screen, confirm the displayed settings and select **Proceed**, or press the back arrow to change the settings.
8. On the Run Check Fax Connection screen, select **Start Checking** and follow the on-screen instructions to check the fax connection and print a report of the check result. If there are any errors reported, try the solutions on the report and run the check again.

If the Select Line Type screen appears, select the correct line type.

If the Dial Tone Detection screen appears, select **Do Not Detect**. However, disabling the dial tone detection function may drop the first digit of a fax number and send the fax to the wrong number.

Parent topic: [Setting Up Basic Fax Features](#)

Related tasks

[Entering Characters on the LCD Screen](#)

Selecting the Line Type

If you connect the product to a PBX phone system or terminal adapter, you must change the product's line type. PBX (Private Branch Exchange) is used in office environments where an external access code such as "9" must be dialed to call an outside line. The default Line Type setting is PSTN (Public Switched Telephone Network), which is a standard home phone line.

Note: This setting can be locked by an administrator. If you can't access or change this setting, contact your administrator for assistance.

1. Press the  home button, if necessary.
2. Select **Settings > General Settings > Fax Settings > Basic Settings > Line Type > PBX**.

You see a screen like this:

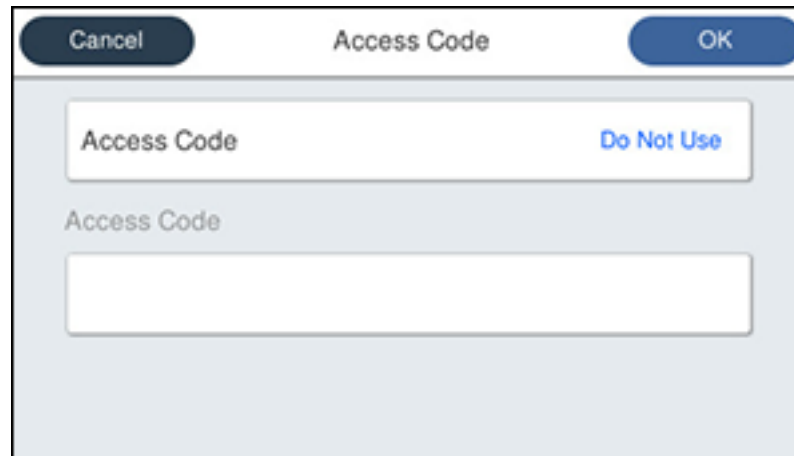

3. Select **Access Code**.
4. Select **Use**.
5. Select the Access Code field.
6. Use the displayed keypad to enter the access code, such as 9, and select **OK**.

Parent topic: [Setting Up Basic Fax Features](#)

Related tasks

[Entering Characters on the LCD Screen](#)

Setting the Number of Rings to Answer

If you connect an external answering machine and select to receive faxes automatically, make sure the Rings to Answer setting is correct. The number of rings should be higher than the number of rings your answering machine is set to for answering a call.

Note: This setting can be locked by an administrator. If you cannot access or change this setting, contact your administrator for assistance.

1. Press the  home button, if necessary.
2. Select **Settings > General Settings > Fax Settings > Basic Settings > Rings to Answer**.

You see a screen like this:



3. Select the number of rings and select **OK**. Make sure to select a number higher than the number of rings your answering machine is set to for answering a call.

Note: An answering machine picks up every call faster than the product, but the product can detect fax tones and start receiving faxes. If you answer the phone and hear a fax tone, check that the product has started receiving the fax, then hang up the phone.

Parent topic: [Setting Up Basic Fax Features](#)

Selecting Advanced Fax Settings

You can select a variety of advanced fax settings.

Note: These settings can be locked by an administrator. If you cannot access or change these setting, contact your administrator for assistance.

1. Press the  home button, if necessary.
2. Select **Settings > General Settings > Fax Settings**.

You see a screen like this:



3. If you want to create shortcuts for up to three fax operations, select **Quick Operation Button** and select a setting and a shortcut button.

Note: These shortcuts are displayed on the Fax Settings tab in the main **Fax** screen.

4. Select the group of settings you want to change.

[Basic Settings - Fax](#)

[Send Settings - Fax](#)

[Receive Settings - Fax](#)

[Report Settings - Fax](#)

[Security Settings - Fax](#)

Parent topic: [Setting Up Fax Features](#)

Basic Settings - Fax

Set the basic options you want to use for incoming and outgoing faxes.

Setting	Options	Description
Fax Speed	Fast(33,600bps)	Sets the speed at which you send and receive faxes.
	Medium(14,400bps)	
	Slow(9,600bps)	
ECM	On	Turns on Error Correction Mode (ECM) to automatically correct errors in sent or received fax data.
	Off	Turns off Error Correction Mode (ECM); color faxes cannot be sent or received.
Dial Tone Detection	On	Automatically dials the number you enter for faxing when the product detects a dial tone.
	Off	Turns off automatic dial tone detection, which may be necessary if the product is connected to a PBX (Private Branch Exchange) or a TA (Terminal Adapter). However, turning this setting off may cause the product to drop the first digit of a fax number.
Line Type	PSTN	Selects a standard phone line (Public Switched Telephone Network).
	PBX	Selects Private Branch Exchange, the type of phone line used in office environments where an access code such as 9 must be used to call an outside line.
Header	Your Phone Number	Select to enter the header information and your phone number for inclusion on outgoing faxes.
	Fax Header	
Receive Mode	Manual	Lets you confirm whether an incoming fax should be printed; a telephone must be connected to the product
	Auto	Automatically receives and prints faxes.

Setting	Options	Description
Distinctive Ring	All	If you are using a Distinctive Ring Service on your phone line, your telephone company can assign two or more phone numbers to the same line and assign different ring patterns to each. If you use this service, select the number of rings for your fax number so your product can receive faxes on the correct number of rings. Select All for phones lines that do not use this service.
	Single	
	Double	
	Triple	
	Double&Triple	
Rings to Answer	1 to 9	Sets the number of rings before your product receives a fax. If Receive Mode is set to Auto and an answering machine is connected to the product, make sure this setting is set higher than the number of rings your answering machine is set to answer a call.
Remote Receive	Off	Lets you start receiving faxes using your phone instead of operating the product (if the Receive Mode is set to Auto). When you select On , you must also set a Start Code . If you are using a cordless handset with its base connected to the product, you can start receiving the fax by entering the code using the handset.
	On	
	Start Code	
Rejection Fax	Various	Lets you automatically reject faxes from blocked numbers, with blank headers, or from unrecognized contacts.

Parent topic: [Selecting Advanced Fax Settings](#)

Send Settings - Fax

Set the send options you want to use for outgoing faxes.

Setting	Options	Description
Wait Time for Next Original	Off	Sets a time in between sending the next fax
	On	
Fax Preview Display Time	Off	Sets a time for previewing the scanned document on the LCD screen before it is sent
	On	

Parent topic: [Selecting Advanced Fax Settings](#)

Receive Settings - Fax

Set the save/forward or print options you want to use for incoming faxes.

Fax Output Settings

Setting	Options	Description
Save to Inbox	Save to Inbox	Saves received faxes in the product's inbox
	Options when memory is full	Selects an action to perform when you receive an incoming fax and the inbox is full
	Inbox Password Settings	Sets a password for the inbox. You cannot set a password if you selected Receive and print faxes for the Options when memory is full setting.
Save to Computer	No	Converts received faxes to PDFs and saves them on a computer connected to the product
	Yes	
	Yes and Print	
Save to Memory Device	No	Converts received faxes to PDFs and saves them on an external memory device connected to the printer
	Yes	
	Yes and Print	You can also create a folder on the memory device by selecting Create a folder to save fax data and following the on-screen instructions.

Print Settings

Setting	Options	Description
Auto Reduction	On	Select to reduce the size of large received faxes to fit on the paper size in the selected paper source.
	Off	Select to print large incoming faxes at their original size on multiple sheets, if necessary.
Split Page Settings	Delete Print Data After Split	Select how to split large incoming faxes across multiple sheets when using the Auto Reduction option.
	Overlap When Split	

Setting	Options	Description
Auto Rotation	On	If you have loaded A4-size paper, select On to rotate landscape-oriented incoming faxes so that they print correctly on the paper.
	Off	
Add Reception Information	On	Select On to include the date, time, the sender's information, and a page number in the header of your incoming faxes.
	Off	
2-Sided	On	Select On to print incoming faxes double sided. You can also select the Binding Margin .
	Off	
Print Start Timing	All Pages Received	Select to print incoming faxes after the product receives all of the pages of the document.
	First Page Received	Select to print incoming faxes as soon as the product receives the first page of the document.
Collation Stack	On	Select On to print incoming faxes so that the pages are stacked in the correct page order. (When the product is low on memory, this option may not be available.)
	Off	
Print Suspend Time	Off	Select On to set a time period to stop automatic printing of faxes or reports and save received faxes in the product's memory. (Make sure there is enough free memory before using this function.)
	On	
	Time to Stop	
	Time to Restart	
Quiet Mode	On	Select On to reduce noise during printing (printing speed may be reduced).
	Off	

Parent topic: [Selecting Advanced Fax Settings](#)

Report Settings - Fax

Set the options you want for fax reports.

Setting	Options	Description
Fax Log Auto Print	Off	Does not print a fax log
	On(Every 30)	Prints a fax log after every 30 fax jobs are completed
	On(Time)	Prints a fax log at a specified time. If the number of completed fax jobs exceeds 30, the fax log prints before the specified time.
Attach Fax Image to Report	Off	Does not include an image on the Transmission Report
	On(Large Image)	Prints a Transmission Report that includes the upper part of the first page of the sent document
	On(Small Image)	Prints a Transmission Report that includes a reduced size of the entire first page of the sent document
Report Format	Simple	Prints a simple fax report
	Detail	Prints a fax report that includes error codes

Parent topic: [Selecting Advanced Fax Settings](#)

Security Settings - Fax

Set the security options you want to use for fax data.

Setting	Options	Description
Direct Dialing Restrictions	Off	Does not restrict dialed fax numbers.
	On	Allows faxing only to numbers stored in the contacts list or history.
	Enter Twice	Requires you to enter fax numbers twice to prevent errors.
Broadcasting Restrictions	Off	Select On to allow only one fax number to be entered as the recipient
	On	
Confirm Address List	Off	Selects whether or not to display a recipient confirmation screen before a fax is sent.
	On	
Backup Data Auto Clear	Off	Automatically erases sent or received fax data from your product's memory.
	On	



Setting	Options	Description
Clear Backup Data	—	Deletes all sent or received fax data remaining in your product's memory; run this function if you are giving away or disposing of your product.

Parent topic: [Selecting Advanced Fax Settings](#)

Setting Up the Fax Utility - Windows

You can set up the FAX Utility for Windows for use with your product.

Note: Before using the FAX Utility for Windows, make sure you have set up the fax features on your product using the product control panel. Also first confirm that you can send and receive faxes using the control panel.

1. Do one of the following:
 - **Windows 10:** Click  and select **EPSON Software**.
 - **Windows 8.x:** Navigate to the **Apps** screen.
 - **Windows (other versions):** Click  or **Start > Programs** or **All Programs > EPSON Software**.
2. Select **FAX Utility**.

The first time you use the FAX Utility, you see this introduction window:

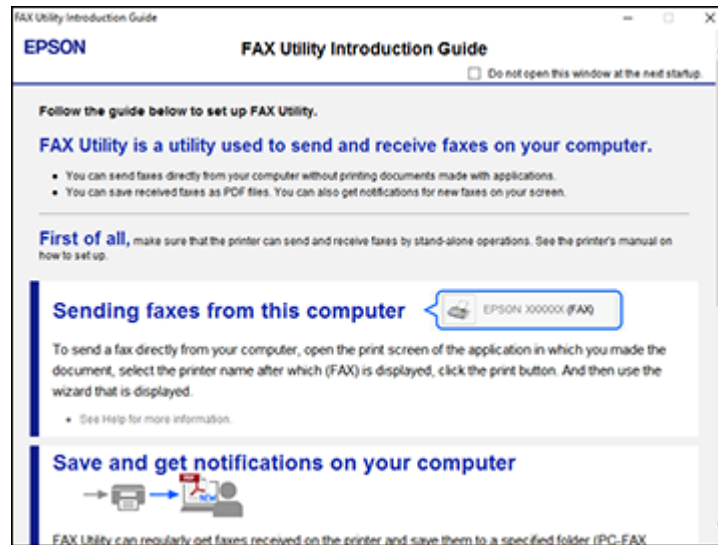

3. Read about the FAX Utility and click **Return to the main window** at the bottom of the window.

You see this window:

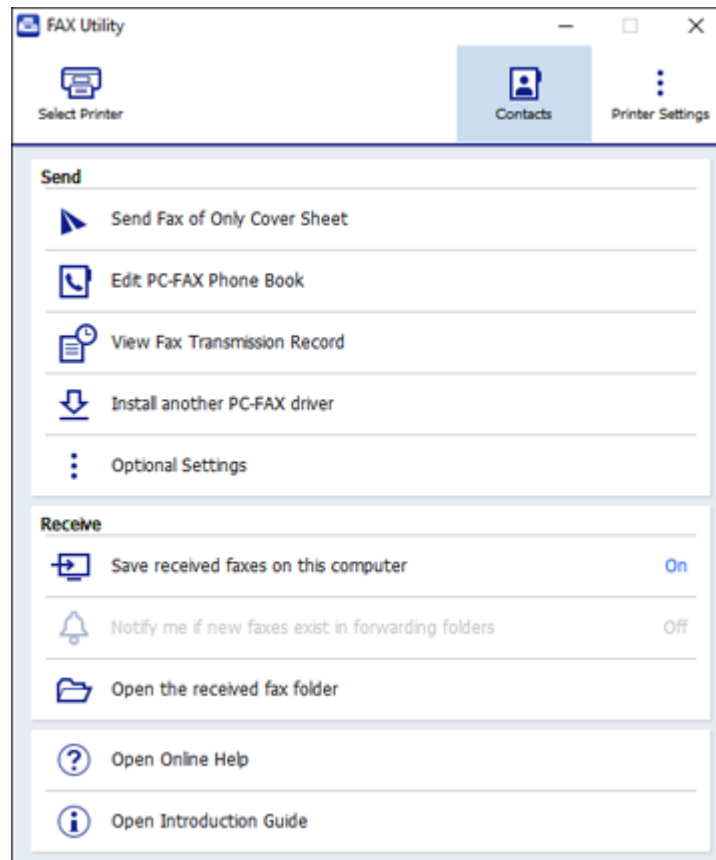

4. Click **Select Printer** and follow the on-screen instructions to transfer your product's fax settings to the FAX Utility.

Note: For detailed information, click **Help** or **Open Online Help**.

Parent topic: [Setting Up Fax Features](#)

Setting Up Fax Features Using the Fax Utility - Mac

You can set up your fax header and select your fax settings using the FAX Utility for Mac.

1. In the Apple menu or the Dock, select **System Preferences**. Select **Print & Fax**, **Print & Scan**, or **Printers & Scanners**, select the **FAX** option for your product, and select **Options & Supplies**. Select **Utility** and select **Open Printer Utility**.
2. Double-click **FAX Utility**, if necessary.

You see a window like this:

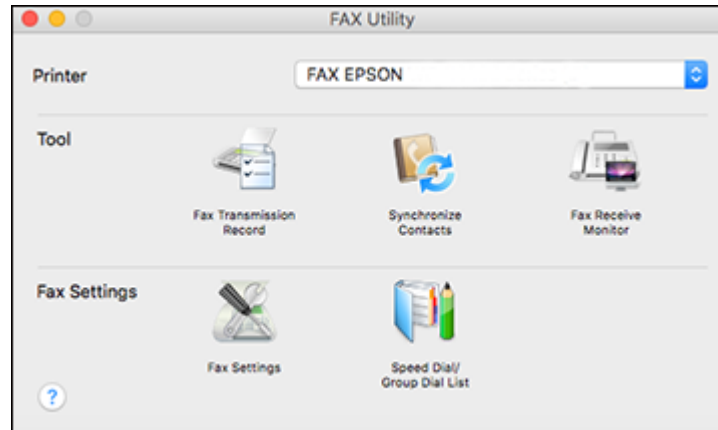

3. Select your **FAX** product in the Printer list.
4. Select **Fax Settings**.
5. Follow the prompts that appear on the screen to enter your fax header information and select your fax settings.

Note: For detailed information, select the FAX Utility ? icon.

Parent topic: [Setting Up Fax Features](#)

Setting Up Contacts and Contact Groups

You can set up a list of contacts and their fax numbers so you can quickly select them for faxing. You can also set up contact groups to send a fax message to multiple contacts.

Note: Contacts can be locked by an administrator. If you cannot access or change contacts, contact your administrator for assistance.

[Setting Up Contacts Using the Product Control Panel](#)

Parent topic: [Faxing](#)

Setting Up Contacts Using the Product Control Panel

You can set up your contacts and contact groups using the control panel on your product.

[Creating a Contact](#)

[Editing or Deleting a Contact](#)

[Creating a Contact Group](#)

[Editing or Deleting a Contact Group](#)

Parent topic: [Setting Up Contacts and Contact Groups](#)

Related tasks

[Receiving Faxes Manually](#)

Creating a Contact

You can create a list of contacts to save frequently used fax numbers.

Note: You can create up to 100 contacts and contact groups combined. You can also enter contacts and contact groups using Web Config.

1. Press the  home button, if necessary.
2. Select **Fax**.

You see a screen like this:

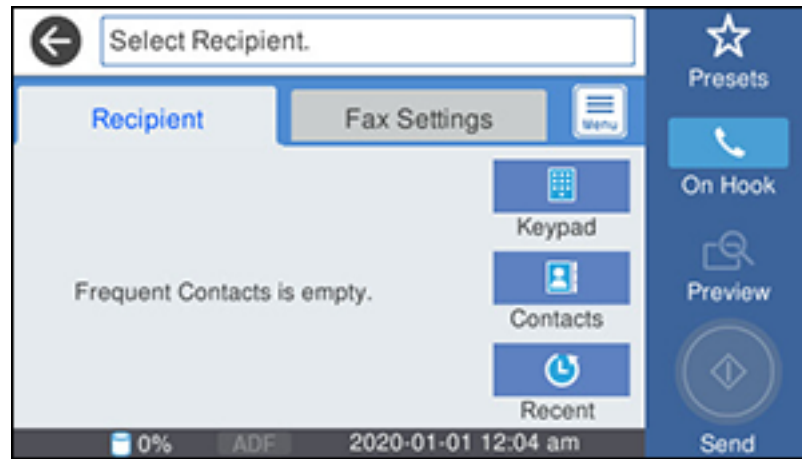

3. Select **Contacts**. Enter the administrator password, if necessary.

You see a screen like this:

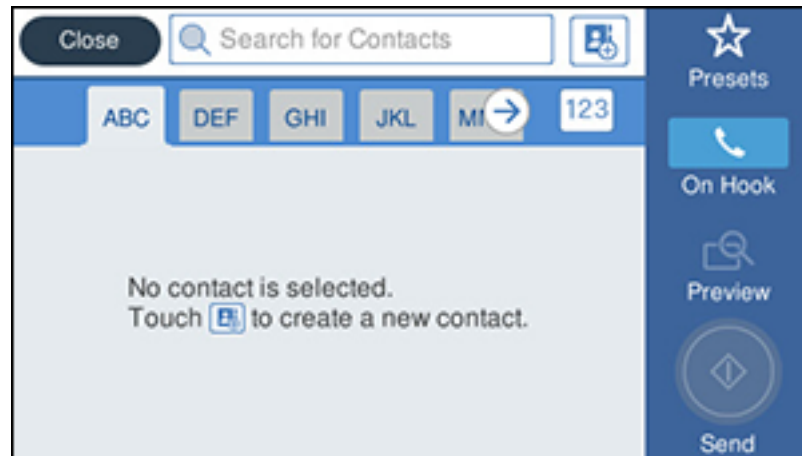

4. Select the  icon.
5. Select **Add Contact**.

You see a screen like this:

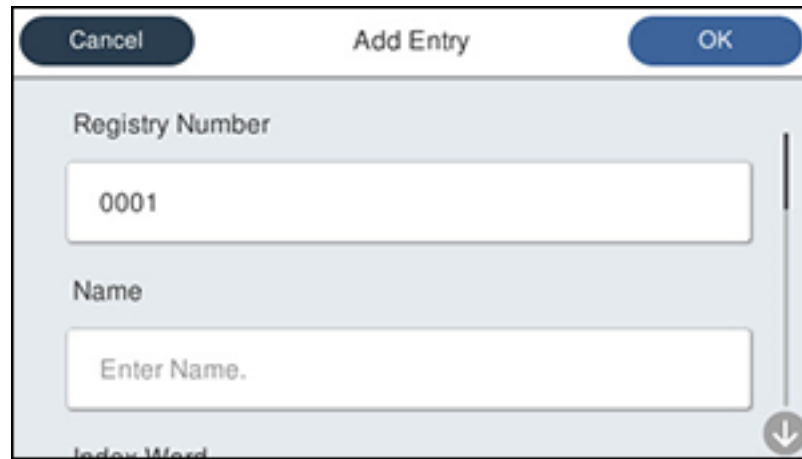
The image shows a screenshot of a mobile application interface titled "Add Entry". At the top, there are three buttons: "Cancel" on the left, "Add Entry" in the center, and "OK" on the right. Below the title bar, there are three input fields. The first field is labeled "Registry Number" and contains the text "0001". The second field is labeled "Name" and contains the placeholder text "Enter Name.". The third field is partially visible at the bottom and is labeled "Index Word". A vertical scrollbar is located on the right side of the input fields, and a downward arrow button is at the bottom right corner of the screen.

6. Select the registry number you want to use for the contact you are adding.
7. Select the **Name** field, use the displayed keyboard to enter the contact name (up to 30 characters), and select **OK**.
8. Select the **Index Word** field, use the displayed keyboard to enter a word to use when searching for an entry (up to 30 characters), and select **OK**.

Note: This field is automatically populated after you enter the name. This field is optional.

9. Select the **Fax Number** field, and use the numeric keypad on the LCD screen or the buttons on the product to enter the fax number. You can enter up to 64 characters. Select **OK** when you are done.

Note: If necessary, enter an outside line access code (such as **9**) at the beginning of the fax number. If the access code has been set up in the **Line Type** setting, enter the **#** pound sign instead of the code.

10. Set the **Fax Speed**, **Subaddress**, and **Password** settings, if necessary.
11. Select **OK**.

Parent topic: [Setting Up Contacts Using the Product Control Panel](#)

Editing or Deleting a Contact

You can edit or delete any of the contacts on your list.

1. Press the  home button, if necessary.
2. Select **Fax**.

You see a screen like this:

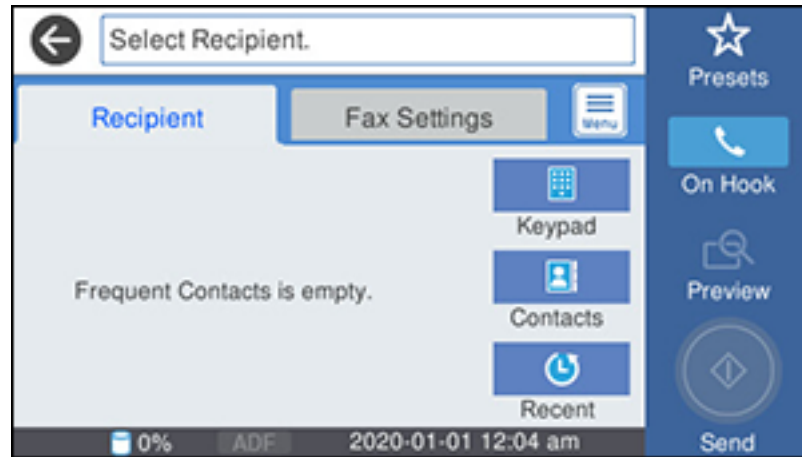

3. Select **Contacts**. Enter the administrator password, if necessary.
4. Select the  icon next to the contact you want to edit or delete.

You see a screen like this:

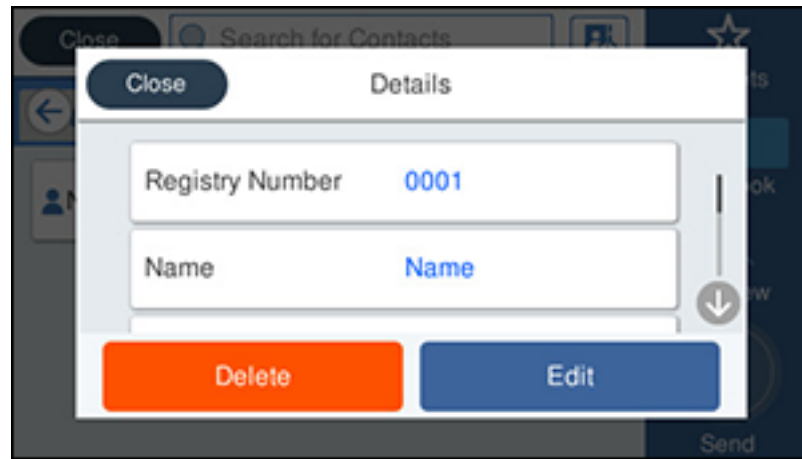

5. Do one of the following:

- To delete the contact, select **Delete** and select **Yes** on the confirmation screen.
- To edit the contact, select **Edit**, select the item you want to change, enter the correct information, and select **OK**. When you are finished editing, select **OK**.

Parent topic: [Setting Up Contacts Using the Product Control Panel](#)

Creating a Contact Group

You can create a group of contacts so that you can easily send faxes to multiple recipients.

Note: You can create up to 100 contacts and contact groups combined.

1. Press the  home button, if necessary.
2. Select **Fax**.

You see a screen like this:

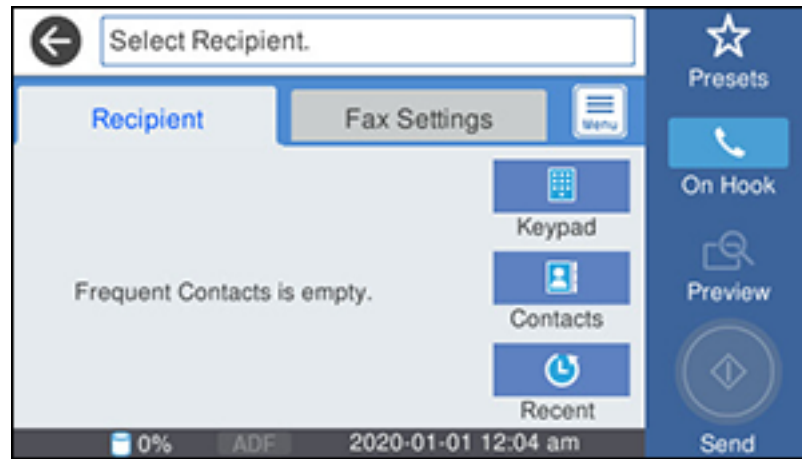

3. Select **Contacts**. Enter the administrator password, if necessary.
4. Select the  icon.
5. Select **Add Group**.

You see a screen like this:

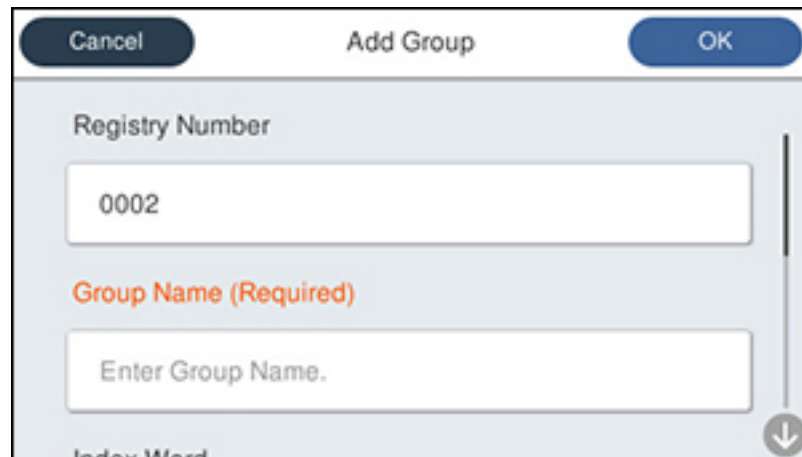

6. Select the registry number you want to use for the group you are adding.
7. Select the **Group Name** field, use the displayed keyboard to enter the group name (up to 30 characters), and select **OK**.
8. Select the **Index Word** field, use the displayed keyboard to enter a word to use when searching for a group (up to 30 characters), and select **OK**.

Note: This field is automatically populated after you enter the group name. This field is optional.

9. Select **Contact(s) Added to the Group**.
You see your contacts list.
10. Select each contact you want to include in your group.
Each selected contact is highlighted.
11. Select **Close**.
12. Select **OK**.

Parent topic: [Setting Up Contacts Using the Product Control Panel](#)

Editing or Deleting a Contact Group

You can edit an existing contact group to add or delete entries. You can also delete the entire contact group.

1. Press the  home button, if necessary.
2. Select **Fax**.

You see a screen like this:

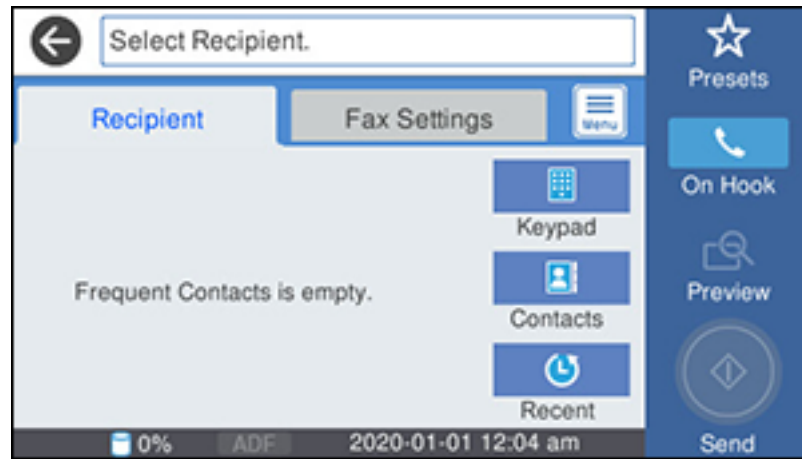

3. Select **Contacts**. Enter the administrator password, if necessary.

4. Select the  icon next to the group you want to edit or delete.

You see a screen like this:

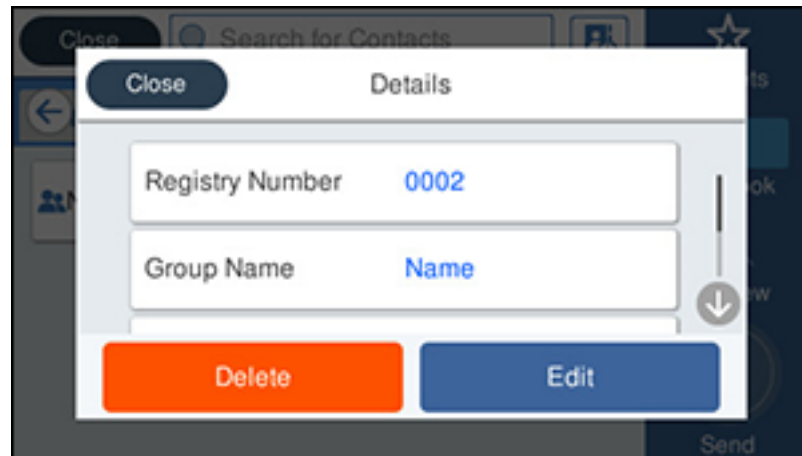

Note: If you want to delete the entire group, select **Delete**.

5. To edit the group, select **Edit**.
6. Select **Contact(s) Added to the Group**.
You see a list of the contacts in your group.
7. Select the contact you want to add or delete.
Each selected contact is highlighted.
8. Select **Close**.
9. Select **OK**.

Parent topic: [Setting Up Contacts Using the Product Control Panel](#)

Sending Faxes

See these sections to send faxes using your product.

[Sending Faxes from the Product Control Panel](#)

[Sending Faxes Using the Fax Utility - Windows](#)

[Sending Faxes Using the Fax Utility - Mac](#)

[Dialing Fax Numbers from a Connected Telephone](#)

Parent topic: [Faxing](#)

Sending Faxes from the Product Control Panel

See these sections to send faxes using the product's control panel.

[Sending a Fax Using the Keypad, Contact List, or History](#)

[Fax Sending Options](#)

[Sending a Fax at a Specified Time](#)

Parent topic: [Sending Faxes](#)

Sending a Fax Using the Keypad, Contact List, or History

You can send a fax from your product control panel by entering the fax number, or selecting the number from either the contact list or fax history.

Note: You can send a black-and-white fax to up to 100 recipients at a time, or send a color fax to one recipient at a time. If your recipient's fax machine does not print in color, your fax is automatically sent in black-and-white.

1. Place your original on the product for faxing.
2. Press the  home button, if necessary.
3. Select **Fax**.

You see a screen like this:

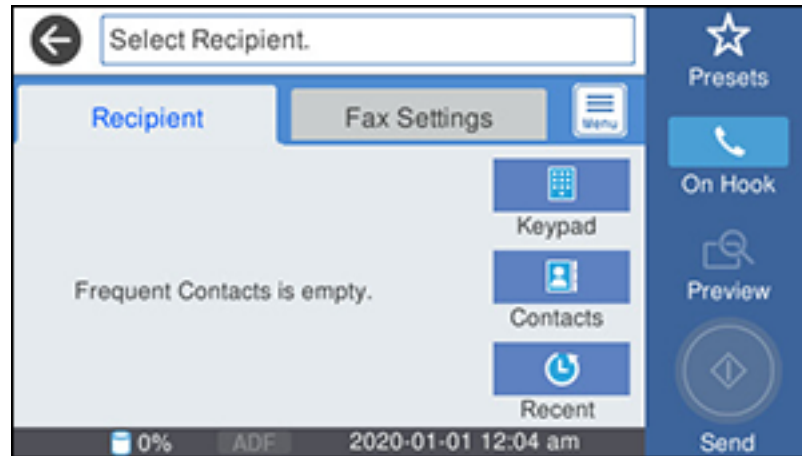

Note: To fax a double-sided document, place your document in the ADF and turn on the **ADF 2-Sided** setting. (You cannot fax double-sided documents in color.)

4. Do one of the following to select fax recipients:
 - Select **Keypad** and enter a fax number. Select **OK** when done. To add another fax number, repeat the same steps. You can also use the numeric keypad on the control panel to enter a fax number.

Note: If direct dialing has been restricted, you can only select the number from the contact list or fax history. If necessary, enter an outside line access code (such as 9) at the beginning of the fax number. If the access code has been set up in the **Line Type** setting, enter the **#** pound sign instead of the code. If your fax number requires a brief pause, select the  icon to insert a pause symbol (-).

- Select **Contacts** to display the contact list. Select one or more contacts (select the contact again to deselect it). You can also select the **Search for Contacts** field to search for recipients by name, index name, or entry number. Select **Close** when you are finished.

- Select **Recent** to display the sent fax history.

Note: To delete entered recipients, select the **Select Recipient** field, select the recipient you want to delete, and select **Remove**.

5. If you need to change any fax settings, select **Fax Settings** and select your settings.
6. If you want to preview your fax in black-and-white on the LCD, press the  **Preview** icon. (If the preview looks incorrect, select **Cancel**, reposition the document or change the fax settings, and repeat this step.)

Note: If you do not touch the preview screen for the amount of time selected as the **Settings > General Settings > Fax Settings > Send Settings > Fax Preview Display Time** setting, your product sends the fax automatically. You cannot preview images when the Direct Send setting is turned on.

7. If you want to save your fax settings for later use, select **Presets** and add a new entry.
8. Select the  **Send** icon.

Note: To cancel faxing, select the  stop button. You can also cancel the job or check the job status from the Job Status menu.

Your product scans your original and prompts you to place additional pages, if necessary.

After scanning your originals, your product dials the number and sends the fax.

Note: If the fax number is busy or there is a problem, the product automatically redials after one minute. While the product is sending a color fax, other features are unavailable.

Parent topic: [Sending Faxes from the Product Control Panel](#)

Related references

[Fax Sending Options](#)

Related tasks

[Selecting the Line Type](#)

[Using Presets](#)

Related topics

[Placing Originals on the Product](#)

[Setting Up Contacts Using the Product Control Panel](#)

Fax Sending Options

While sending a fax, you can select **Fax Settings** and select these options.

Setting	Options	Description
Resolution	Standard	Adjusts the scan resolution and print quality of outgoing faxes
	Fine	
	Super Fine	
	Ultra Fine	
Density	Varying levels available	Lets you select from various density levels
Remove Background	Auto	Automatically removes any background color on scanned images
	Varying levels available	Lets you select from various levels of background color adjustment
Sharpness	Varying levels available	Lets you adjust the sharpness level of outgoing faxes
ADF 2-Sided	Off	Select On to enable 2-sided faxing from the ADF. The Direct Send option and color faxing are disabled when you turn on this setting.
	On	
Continuous Scan (ADF)	Off	Select On to have the product to ask if you want to scan another page after a document in the ADF has finished scanning
	On	
Original Size (Glass)	Various sizes	Select the size for a document placed on the scanner glass, or select Auto Detect to have the product automatically detect the size of the document.
	Auto Detect	
Color Mode	B&W	Select whether to scan images in color or black and white
	Color	

Setting	Options	Description
Direct Send	Off	Select On to send black-and-white faxes to a single recipient as soon as the connection is made, without saving the scanned image to memory. You cannot use this setting when sending a color fax, using ADF 2-sided or sending a fax to multiple recipients.
	On	
Send Fax Later	Off	Select On to send the current fax at a selected time
	On	
Add Sender Information	Off	Lets you include a header, your phone number, or a destination list in the selected location on your outgoing faxes
	Outside of Image	
	Inside of Image	
Transmission Report	Print on Error	Lets you select when to print transmission reports
	Print	
	Do Not Print	

Parent topic: [Sending Faxes from the Product Control Panel](#)

Sending a Fax at a Specified Time

You can send a fax at a time of your choice.

Note: Make sure the product's date and time settings are correct. You can only send faxes in black-and-white when you use this option.

1. Place your original on the product for faxing.
2. Press the  home button, if necessary.
3. Select **Fax**.

You see a screen like this:

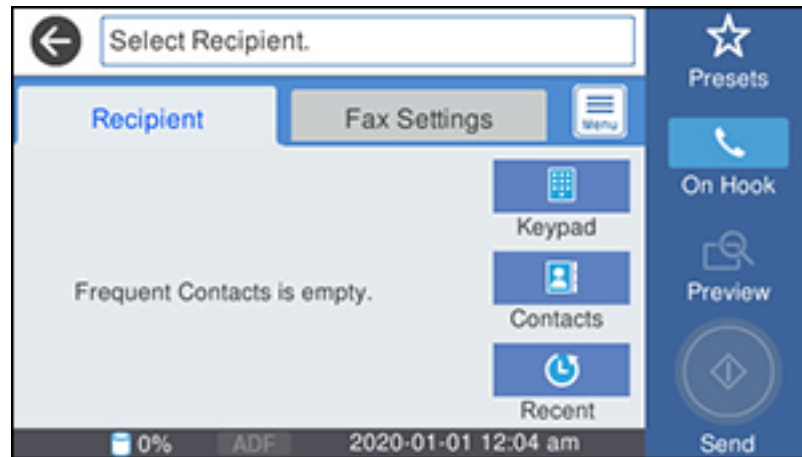

4. Enter a fax number or select a number from the **Contacts** or **Recent** lists.
5. Select **Fax Settings**.
6. Select **Send Fax Later**.
7. Select **On**.
8. Select **Time**, use the displayed keypad on the LCD screen to enter your desired time, and select **OK**.
9. Select the  **Send** icon.

Note: To cancel faxing, select the  stop button.

After scanning your originals, your product dials the number and sends the fax at the specified time.

Note: If the product is turned off at the specified time, the fax is sent when it is powered on.

Parent topic: [Sending Faxes from the Product Control Panel](#)

Sending Faxes Using the Fax Utility - Windows

You can send a fax from a printing program in Windows. You can fax up to 100 pages at a time, including a cover sheet.

1. Open the file you want to fax and select the print command.

You see a window like this:

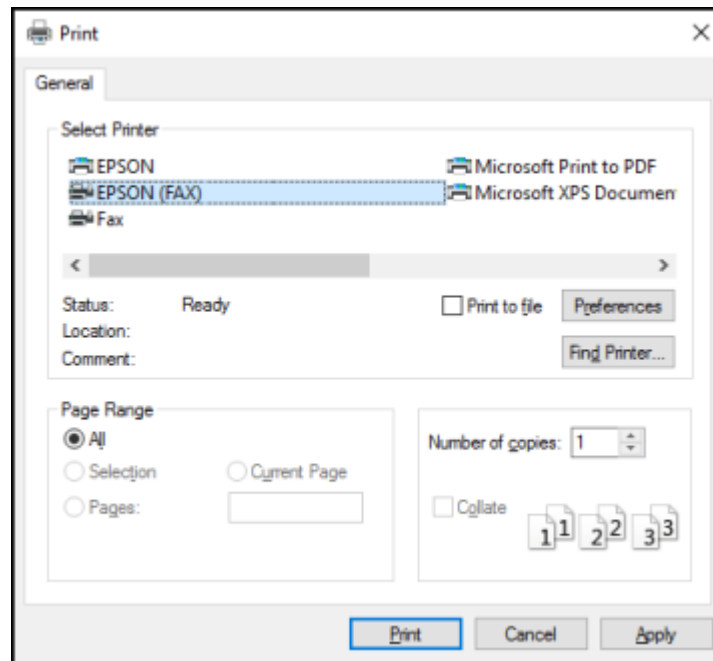

2. Select your product with the **FAX** option as the printer.
3. To change the Paper Size, Orientation, Color, Image Quality, or Character Density settings, click the **Preferences** or **Properties** button, change the necessary settings, and click **OK**.

Note: If you see a **Setup**, **Printer**, or **Options** button, click it. Then click **Preferences** or **Properties** on the next screen. For more information about selecting fax print settings, click **Help**.

4. Select the Page Range as necessary. (Leave the Number of copies set to 1.)
5. Click **Print** or **OK**.

If you're faxing for the first time, you see a window like this one:

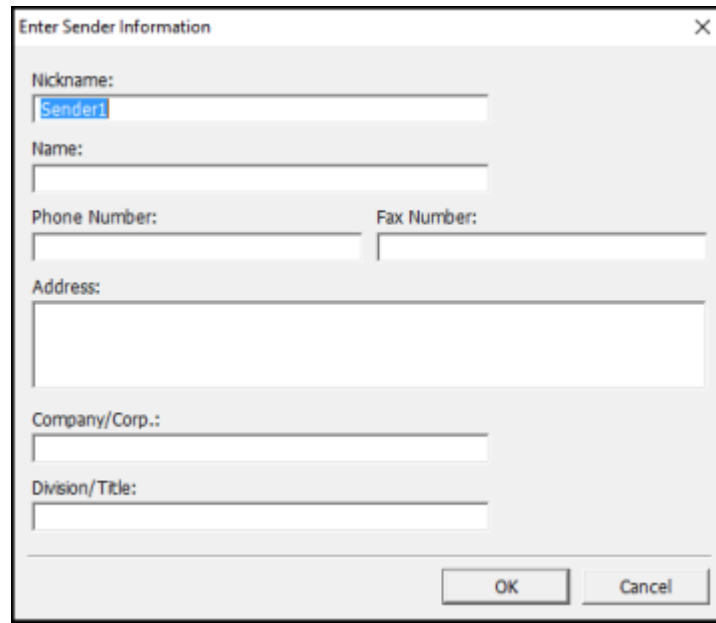

The image shows a dialog box titled "Enter Sender Information" with a close button (X) in the top right corner. The dialog contains several input fields: "Nickname:" with the text "Sender1" entered; "Name:" (empty); "Phone Number:" and "Fax Number:" (both empty); "Address:" (a large empty text area); "Company/Corp.:" (empty); and "Division/Title:" (empty). At the bottom right, there are "OK" and "Cancel" buttons.

6. Enter your sender information so that recipients can identify the origin of the fax. Then click **OK** to save the sender information.

You see a window like this:

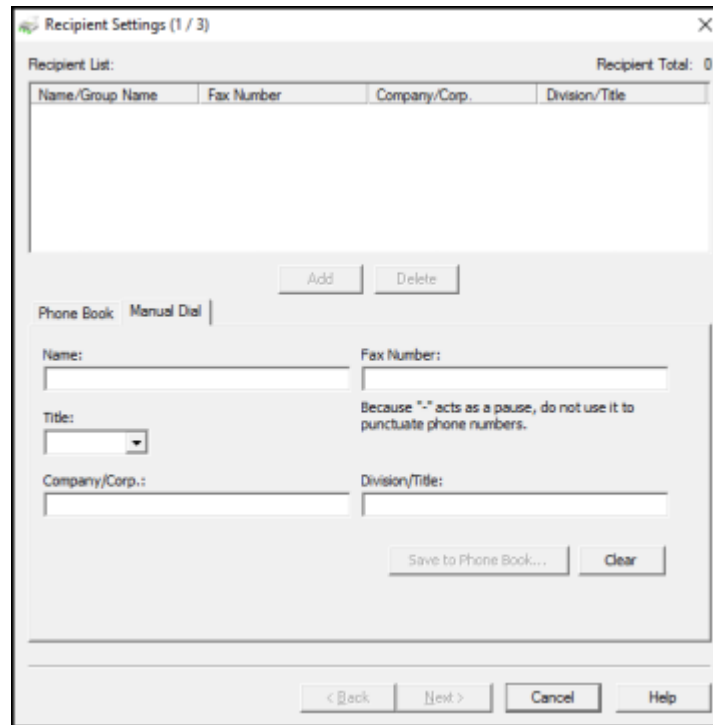

7. Enter the recipient's name and fax number or select a recipient from the phonebook, then click **Next**.

Note: For detailed instructions on using the Epson FAX Utility, click **Help**.

8. Select a cover sheet and enter a subject and message, then click **Next**.
9. Click **Send** to transmit your fax.

Parent topic: [Sending Faxes](#)

Sending Faxes Using the Fax Utility - Mac

You can send a fax from a Mac printing program using the FAX Utility. You can fax up to 100 pages at a time, including a cover sheet.

1. Open the file you want to fax.

2. Select the print command in your application.

Note: You may need to select a print icon on your screen, the **Print** option in the **File** menu, or another command. See your application's help utility for details.

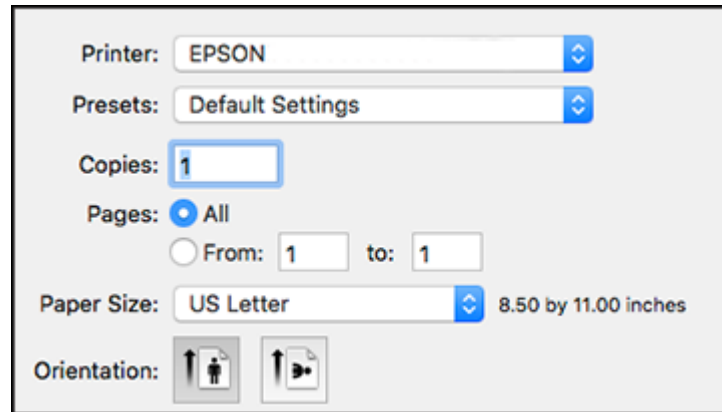

The image shows a print settings dialog box with the following controls:

- Printer:** A dropdown menu set to "EPSON".
- Presets:** A dropdown menu set to "Default Settings".
- Copies:** A text input field containing the number "1".
- Pages:** A radio button labeled "All" is selected. Below it, an unselected radio button is followed by "From: 1" and "to: 1" in separate input fields.
- Paper Size:** A dropdown menu set to "US Letter" with the dimensions "8.50 by 11.00 inches" displayed to the right.
- Orientation:** Two icons: the first shows a vertical page with an upward arrow, and the second shows a horizontal page with a rightward arrow.

3. Select your product **FAX** option as the **Printer** setting.
4. If necessary, click the arrow next to the Printer setting or the **Show Details** button to expand the print window.
5. Select the number of pages you are faxing as the **Pages** setting.

Note: Leave the **Copies** setting set to **1**.

6. Select **Recipient Settings** from the pop-up menu.

You see this window:

Recipient Settings

Recipient List:

Name	Company/Corp.	Fax Number
------	---------------	------------

Add:

Name:

Company/Corp.:

Fax Number:

A hyphen (-) is available only at the beginning of the phone number because it acts as a pause in dialing.

External Access Prefix:

Cancel Fax

7. Do one of the following to choose your recipient:
 - Select a name or group from the **Recipient List**.
 - Enter a name, company, and fax number and click the **+** button.
 - Click the  icon and select a recipient from your address book.
8. Select **Fax Settings** from the pop-up menu.

You see this window:

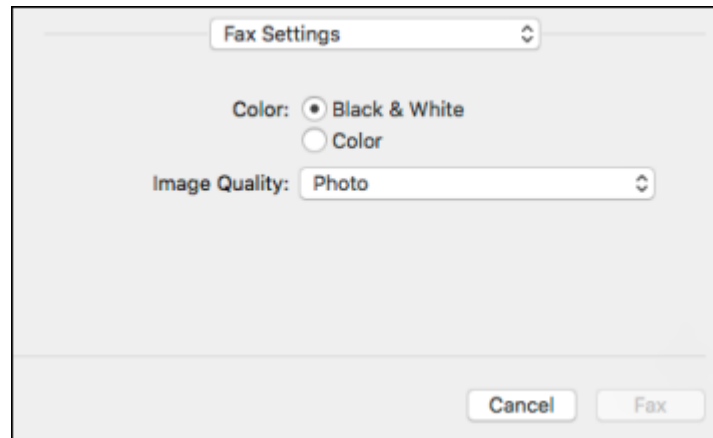

9. Select the **Color** and **Image Quality** settings you want to use for your fax.
10. Click **Fax**.

Parent topic: [Sending Faxes](#)

Dialing Fax Numbers from a Connected Telephone

If you have connected a telephone to the **EXT** port on your product, you can send a fax by dialing the fax number from the connected telephone. If the recipient's phone number and fax number are the same, you can speak to the recipient before sending the fax.

1. Place your original on the product for faxing.
2. Press the  home button, if necessary.
3. Dial the fax number from the connected telephone. Speak to the recipient if necessary.

Note: If you are using a pre-paid calling card, enter the number and password required to use the card before entering the destination fax number.

4. Select **Fax** on the LCD screen.

5. Select **Fax Settings** and select any settings as necessary.

Note: Your product now communicates with the recipient's fax machine. Do not hang up the telephone.

6. When you hear a fax tone, select the  **Send** icon to start sending the fax.

Note: If your recipient's fax machine does not print in color, your fax is automatically sent in black-and-white.

7. Hang up the telephone.

Parent topic: [Sending Faxes](#)

Receiving Faxes

See these sections to receive faxes with your product.

[Fax Reception](#)

[Receiving Faxes Automatically](#)

[Receiving Faxes Manually](#)

[Receiving a Fax by Polling](#)

[Viewing a Fax on the LCD Screen \(Using the Inbox\)](#)

[Saving Faxes to an External USB Device](#)

Parent topic: [Faxing](#)

Fax Reception

Your product will automatically receive and print faxes when you set the Receive Mode to **Auto**.

If you connected a telephone to your product so you can use the same phone line for faxes and voice calls, you can also set your product to receive faxes manually. This allows you to check for a fax tone using the telephone and press a button on your product to receive the fax.

Make sure to load paper in your product and select your fax settings before receiving a fax.

Note: If you run out of paper during fax printing, load more paper and press the button indicated on your product's LCD screen to continue.

Parent topic: [Receiving Faxes](#)

Receiving Faxes Automatically

To receive faxes automatically, make sure Receive Mode is set to **Auto** (the default setting for the product).

To change the Receive Mode if necessary, select **Settings > General Settings > Fax Settings > Basic Settings > Receive Mode**.

If an answering machine is connected, make sure the product's **Rings to Answer** setting is set higher than the number of rings your answering machine is set to answer a call. For example, if the answering machine is set to pick up on the fourth ring, set the product to pick up on the fifth ring or later.

Parent topic: [Receiving Faxes](#)

Related references

[Basic Settings - Fax](#)

Related tasks

[Receiving Faxes Manually](#)

Receiving Faxes Manually

You can set up your product to receive faxes manually by setting the Receive Mode to **Manual**. This lets you check for a fax tone on the connected telephone before receiving a fax.

1. To change the Receive Mode, select **Settings > General Settings > Fax Settings > Basic Settings > Receive Mode** and select **Manual**.
2. When the connected telephone rings, answer the call.
3. If you hear a fax tone, select **Fax** on the LCD display.
4. Select **Send/Receive**.
5. Select **Receive**.
6. Select the  **Receive** icon to start receiving the fax.
7. Hang up the telephone.

Parent topic: [Receiving Faxes](#)

Related references

[Basic Settings - Fax](#)

Related tasks

[Receiving Faxes Automatically](#)

Receiving a Fax by Polling



You can use polling to receive a fax from another fax machine (such as a fax information service).

Note: You cannot use polling to receive a fax from a fax information service that uses audio guidance.

1. Press the  home button, if necessary.
2. Select **Fax**.

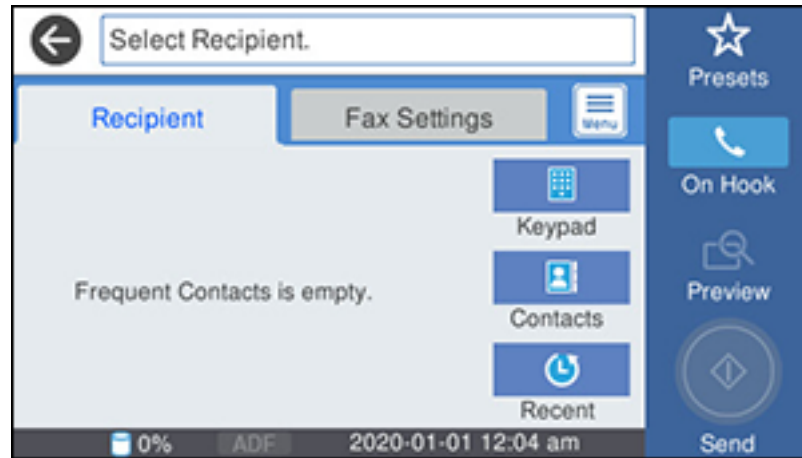
You see a screen like this:



3. Select the  icon.
4. Select **Extended Fax**.
5. Set **Polling Receive** to **On**.
6. Select **Close**.
7. Select **Close**.
8. Enter the fax number you expect to receive the fax from.
9. Select the  **Polling** icon to start receiving the fax.

Parent topic: [Receiving Faxes](#)

Viewing a Fax on the LCD Screen (Using the Inbox)

You can save received faxes in your product's memory and view them on the LCD screen.

1. Press the  home button, if necessary.
2. Select **Settings**.
3. Select **General Settings**.





4. Scroll down and select **Fax Settings**.
5. Select **Receive Settings**.
6. Select **Fax Output Settings**.



7. Select **Save to Inbox**.
8. Set **Save to Inbox** to **On**.
9. Select **Option When Memory is Full** and choose an option.
10. Select **Inbox Password Settings** to set, change, or reset the password for the inbox.

Note: You cannot set an Inbox password if you chose to print faxes when the inbox is full.

11. Press the  home button.
12. Select . Select the inbox you want to view and enter the inbox password, if necessary.
13. Select the fax you want to view.

You see the fax displayed on the screen.

14. Press the  icon.
15. Select one of the printing or deleting options, and follow the on-screen instructions.

Note: Delete faxes after you print or view them to prevent the product's memory from filling up. When the memory is full, you can only print or refuse incoming faxes.

Parent topic: [Receiving Faxes](#)

Saving Faxes to an External USB Device

You can save incoming faxes to an external USB device connected to your product.

1. Insert a supported external USB device into the product's USB port.
2. Press the  home button, if necessary.

3. Select **Settings** > **General Settings** > **Fax Settings** > **Receive Settings** > **Fax Output Settings**.
You see a screen like this:



4. Select **Save to Memory Device**
5. Select **Yes** to save the fax or **Yes and Print** to save and print the fax.

Parent topic: [Receiving Faxes](#)

Checking Fax Status



You can check the status of current fax jobs, or faxes that have been received or sent on the product control panel.

1. Press the  home button, if necessary.
2. Select **Fax**.

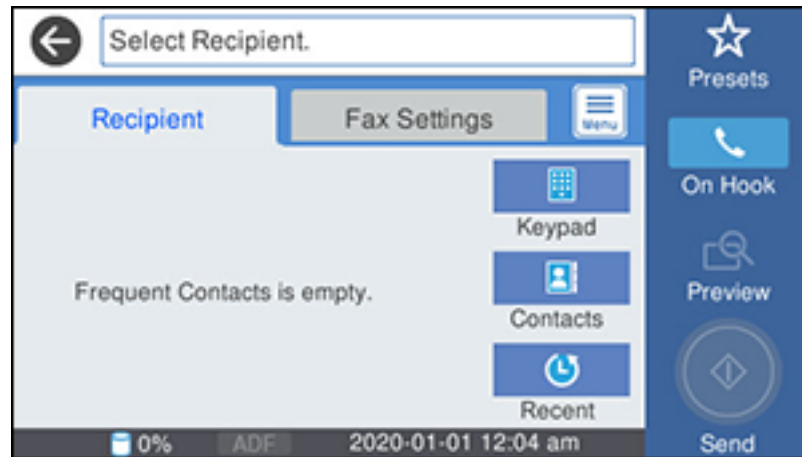
You see a screen like this:



3. Select the  icon.
4. Select **Transmission Log** and select the fax job you want to check.

Note: If you see a numbered icon above the  icon on your product's LCD screen or the  received fax light is flashing, received faxes have been temporarily saved to the product's memory.

Parent topic: [Faxing](#)

Printing Fax Reports

You can print several types of fax reports whenever necessary. You can also print the fax log printed automatically by turning on **Fax Log Auto Print**.

1. Press the  home button, if necessary.
2. Select **Fax**.

You see a screen like this:

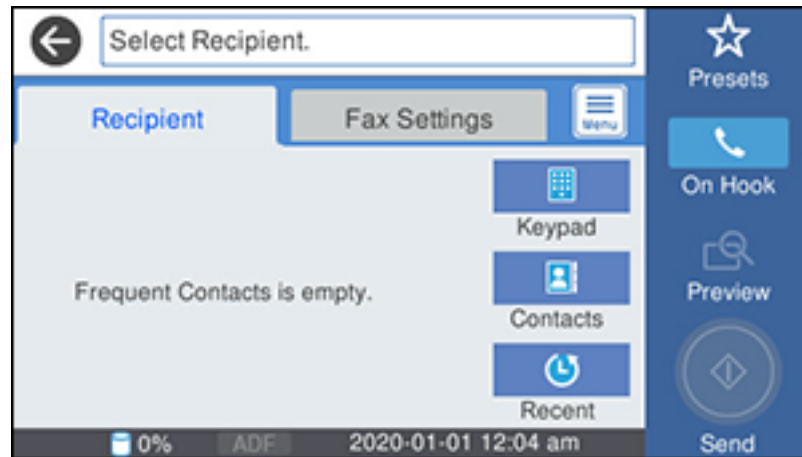

3. Select the  icon.
4. Select **Fax Report**.
5. Select the fax report you want to print.

[Fax Report Options](#)

Parent topic: [Faxing](#)

Fax Report Options

Select the fax report or list you want to print.

Last Transmission

Print a report on the previous fax that was sent or received through polling. You can use the **Fax Settings > Transmission Report** setting to print the report automatically.

Fax Log

View or print a report on recent fax transmissions. You can use the **Settings > General Settings > Fax Settings > Report Settings > Fax Log Auto Print** setting to print the report automatically.

Fax Settings List

Print a list of the current fax communication settings.

Protocol Trace

Print a detailed report for the previous sent or received fax.

Parent topic: [Printing Fax Reports](#)

Using External USB Devices with Your Product

Follow the instructions here to work with an external USB device connected to your product.

[Connecting a USB Device](#)

[Disconnecting a USB Device](#)

[Viewing and Printing from the LCD Screen](#)

[Transferring Files on a USB Device](#)

Connecting a USB Device

Connect a USB device or its USB cable to the USB port on the front of the product.

To view instructions on connecting a USB device or cable, select , then select **How To > USB Memory Connection**.

Note: Epson cannot guarantee the compatibility of your device. Make sure the files on the device are compatible with the product.

[USB Device Photo File Specifications](#)

Parent topic: [Using External USB Devices with Your Product](#)

Related tasks

[Disconnecting a USB Device](#)

USB Device Photo File Specifications

You can use USB devices with your product containing files that meet these specifications.

File format	JPEG with the Exif version 2.31 standard taken by digital cameras with the DCF (Design Rule for Camera File system) version 1.0 or 2.0 standard TIFF 6.0-compliant uncompressed images: RGB full-color or binary (not CCITT-encoded) PDF created by the Scan to Memory Device option
Image size	80 × 80 pixels to 10200 × 10200 pixels
File size	Up to 2GB

Number of files	JPEG: Up to 9990*
	TIFF: Up to 999
	PDF: Up to 999

* If the number of files exceeds 999, the files are displayed in groups.

Parent topic: [Connecting a USB Device](#)

Disconnecting a USB Device

After you finish working with a USB device, follow these steps to remove it.

1. If your product is connected to your computer using a USB cable, do one of the following:
 - **Windows:** Open the **My Computer**, **Computer**, **This PC**, or **Windows Explorer** utility. Then right-click the name of your USB device (listed as a removable disk) and select **Eject**.
 - **Mac:** Drag the removable disk icon for your USB device from the desktop into the trash.

Caution: Do not remove a USB device before completing the procedure above or you may lose data from the flash drive.

2. Pull the USB device or cable out of the USB port on the front of the product.

Parent topic: [Using External USB Devices with Your Product](#)

Viewing and Printing from the LCD Screen

See these sections to view and print photos or other files displayed on your product's LCD screen.

[Printing JPEG Photos](#)

[Printing TIFF Files](#)

[Print Setting Options - Device Mode](#)

Parent topic: [Using External USB Devices with Your Product](#)

Printing JPEG Photos

You can select JPEG photos for printing as you view them on the LCD screen.

1. Press the  home button, if necessary.
2. Select **Memory Device**.

3. Select **JPEG**.

Note: If you have more than 999 JPEG images on your device, the images are divided into groups, and you must first select the group you want to display.

4. Do one of the following to select your photos:
 - In **Tile View**, select the thumbnail images of the photos you want to print.
 - In **Single View**, select the thumbnail image of the photo you want to print, then press the left or right arrow buttons to scroll through and select additional photos, or select **Tile View** to return to the thumbnail image view and select additional photos.
 - To select all photos, select the  menu icon and select **Select All Images**.
5. Select **Proceed to Print**.
6. To change the print settings, select **Basic Settings** and select the necessary settings.
7. To adjust the photos (adjustments modify only your printed copies, not the original files), select **Advanced** and make the necessary adjustments.
8. Select **Copies** on the LCD screen and use the numeric keypad on the screen to select the number of copies (up to 99).
9. When you are ready to print, select the **Print** icon.

Note: To cancel printing, select **Cancel** on the LCD screen, then select **Cancel** again to confirm.

Parent topic: [Viewing and Printing from the LCD Screen](#)

Related references

[Print Setting Options - Device Mode](#)

[Print Setting Options - Device Mode](#)

Printing TIFF Files

You can select and print TIFF files from a USB flash drive.

1. Press the  home button, if necessary.
2. Select **Memory Device**.
3. Select **TIFF**.

You see a list of the available files.

4. Select the file you want to print.
You see information about the file.
5. Do the following as necessary:
 - To print more than one copy, select **Copies** on the LCD screen and use the numeric keypad on the screen to select the number of copies (up to 99).
 - To change the print settings, select **Basic Settings** or **Advanced** and select the necessary settings.
6. When you are ready to print, select the **Print** icon.

Note: To cancel printing, select **Cancel**, then select **Cancel** again to confirm.

Parent topic: [Viewing and Printing from the LCD Screen](#)

Related references

[Print Setting Options - Device Mode](#)

[Print Setting Options - Device Mode](#)

Print Setting Options - Device Mode

Select the print settings you want to use when printing from a USB device.

Note: Not all options or settings may be available, depending on the file format.

Basic Settings

Print settings	Available options	Description
Paper Setting	Various paper size and type settings	Indicates the source that contains the paper size and type you want to print on
Color Mode	B&W	Prints the photo in black and white
	Color	Prints the photo in color

Advanced settings

Print settings	Available options	Description
Layout	Borderless	Expands the image to the edge of the paper (slight cropping may occur)
	With Border	Leaves a small margin around the image
	20-up	Prints 20 images on one page
	Index	Prints thumbnail images with file information
Fit Frame	On	Automatically crops the photo to fit into the selected photo layout
	Off	Turns off automatic cropping
Quality	Standard	Provides good quality for most prints
	Best	Provides the highest quality for special prints
Date	Various date formats	Prints the date the photo was taken on the photo in the format you select
Fix Photo	Auto	Automatically adjusts the brightness, contrast, and saturation of the photo based on the setting that is selected
	People	
	Landscape	
	Night Scene	
	Enhance Off	Turns off automatic adjustments; see Note below
Fix Red-Eye	On	Automatically fixes the red-eye effect in photos
	Off	
Print Order	Last Page on Top	Select the order for printing multi-page TIFF files
	First Page on Top	

Note: Fix Photo uses a sophisticated face recognition technology to optimize photos that include faces. For this to work, both eyes and the nose must be visible in the subject's face. If your photo includes a face with an intentional color cast, such as a statue, you may want to turn off **Fix Photo** to retain the special color effects.

Parent topic: [Viewing and Printing from the LCD Screen](#)

Transferring Files on a USB Device

You can transfer files to and from a USB device inserted into the USB port on the front of your product.

[Setting Up File Sharing for File Transfers from Your Computer](#)

[Transferring Files from a USB Device to Your Computer](#)

Parent topic: [Using External USB Devices with Your Product](#)

Setting Up File Sharing for File Transfers from Your Computer

Before you transfer files from a computer to a USB device inserted into the USB port on the front of your product, you may need to set up your product's file sharing settings.

Caution: Remove the USB device before you change this setting or you may lose data from the device.

1. Press the  home button, if necessary.
2. Select **Settings**.
3. Select **General Settings**.

You see a screen like this:



4. Select **Printer Settings**.
5. Select **Memory Device Interface**.

You see a screen like this:

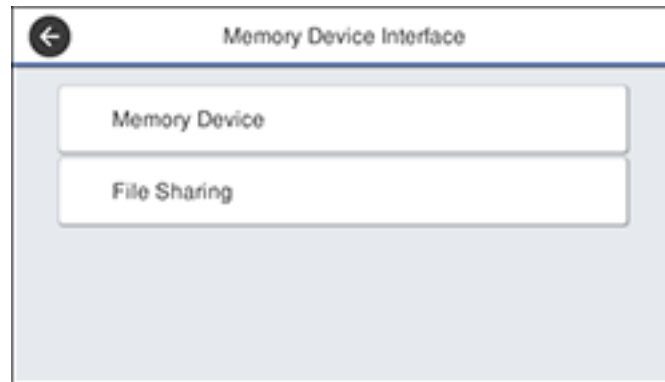

6. Make sure **Memory Device** is set to **Enable**.
7. Select **File Sharing**.
8. Select the way your computer is connected to the product: either **USB** or **Network**.

Parent topic: [Transferring Files on a USB Device](#)

Transferring Files from a USB Device to Your Computer

You can transfer files to and from a USB device inserted into the USB port on the front of your product and a computer connected to your product.

Note: Do not transfer files to and from a USB device while you are printing from the device.

1. Make sure your product is connected to a computer.
2. Insert a USB device or its USB cable into the USB port on the front of your product.
3. Do one of the following to access your USB device files from your computer:
 - **Windows:** Open the **My Computer**, **Computer**, **This PC**, or **Windows Explorer** utility, then select the removable disk icon.
 - **Mac with a USB connection:** Look for the removable disk icon on your desktop, then select it.
 - **Mac with a network connection:** Select the hard drive icon on your desktop or select **Computer** from the **Go** menu, select your product in the **SHARED** section of the sidebar (you may need to widen the sidebar to see the name), and select the **USBSTORAGE** icon.

4. Select the folder that contains your files.
5. Drag the files you want to transfer to the desired folder on your computer or on your USB device.

Note: Your product's LCD screen does not update to display new information about your USB device after you copy files to it or delete files from it. Remove and insert the USB device to update the information.

Parent topic: [Transferring Files on a USB Device](#)

Replacing Ink Cartridges and Maintenance Boxes

The maintenance box stores ink that gets flushed from the system during print head cleaning. When an ink cartridge is expended or the maintenance box is at the end of its service life, you need to replace it.

You may also need to replace a cartridge that is more than six months old if your printouts do not look their best, even after cleaning and aligning the print head.

Note: Please dispose of your used Epson branded ink cartridges and maintenance boxes responsibly and in accordance with local requirements. If you would like to return your used ink cartridges and maintenance boxes to Epson for proper disposal, please go to [epson.com/recycle](https://www.epson.com/recycle) for more information.

Ink Safety Precautions

[Check Cartridge and Maintenance Box Status](#)

[Purchase Epson Ink Cartridges and Maintenance Box](#)

[Removing and Installing Ink Cartridges](#)

[Printing with Black Ink and Expended Color Cartridges](#)

[Conserving Low Black Ink with Windows](#)

[Replacing the Maintenance Box](#)

Ink Safety Precautions

- Keep ink cartridges and maintenance box out of the reach of children and do not drink the ink.
- Keep the ink cartridges out of direct sunlight.
- Store ink cartridges in a cool, dark place; do not store the ink cartridges in high or freezing temperatures.
- Be careful when you handle used ink cartridges; there may be ink remaining around the ink supply port. If ink gets on your skin, wash it off with soap and water. If it gets in your eyes, flush them immediately with water.
- Do not dismantle an ink cartridge. This could damage the print head.
- Do not disassemble or modify the ink cartridge or maintenance box; otherwise ink may get into your eyes or on your skin or you may not be able to print normally.
- Do not shake cartridges too vigorously; this can cause them to leak.
- Do not drop or knock ink cartridges against hard objects; this can cause leakage.
- Do not remove or tear the label on the cartridge; this can cause leakage.

- Use an ink cartridge before the date printed on its package or within six months of opening the package, whichever is earlier.
- Store ink cartridges with their bottoms down. Do not store cartridges upside down.
- After bringing an ink cartridge inside from a cold storage site, allow it to warm up at room temperature for at least three hours before using it.
- Do not open the ink cartridge package until you are ready to install it in the printer. The cartridge is vacuum packed to maintain its reliability. Leaving a cartridge unpacked for a long time before using it may prevent normal operation.
- Do not break the hooks on the side of the cartridge when removing it from the packaging.
- Do not shake cartridges after opening their packages; this can cause them to leak.
- You must remove the yellow tape from the cartridge before installing it; otherwise, print quality may decline or you may not be able to print.
- Do not remove the transparent seal from the bottom of the cartridge. This may cause the cartridge to become unusable.
- Do not touch the green IC chip on the side of the cartridge. This may prevent normal operation.
- Make sure to install all ink cartridges. The printer only works when all ink cartridges are properly installed.
- Do not replace ink cartridges with the power off. Do not move the print head by hand; otherwise, you may damage the printer.
- Do not turn off the product during ink charging. If ink charging is incomplete, you may not be able to print.
- If you remove an ink cartridge for later use, protect the ink supply area from dirt and dust and store it in the same environment as the product. Note that there is a valve in the ink supply port, making covers or plugs unnecessary, but care is needed to prevent the ink from staining items that the cartridge touches. Do not touch the ink cartridge ink supply port or surrounding area.
- Install a new ink cartridge immediately after removing an expended one. Leaving cartridges uninstalled can dry out the print head and may prevent the product from printing.
- Do not turn off the printer during cartridge replacement. Otherwise, ink remaining in the print head nozzles will dry out and you may not be able to print.
- Only remove an ink cartridge when you are ready to replace it. Ink cartridges with low ink status may not be used when reinserted.
- Do not put your hand inside the product or touch any cartridges during printing.

- Removed ink cartridges may have ink around the ink supply port, so be careful not to get any ink on the surrounding area when removing the cartridges.

Ink Consumption

- This printer uses ink cartridges equipped with a green chip that monitors information such as the amount of remaining ink for each cartridge. This means that even if the cartridge is removed from the printer before it is expended, you can still use the cartridge after reinserting it back into the printer. However, when reinserting a cartridge, some ink may be consumed to guarantee printer performance.
- To ensure you receive premium print quality and to help protect your print head, a variable ink safety reserve remains in the cartridge when your printer indicates that it is time to replace the cartridge. Quoted ink yields do not include this reserve.
- Quoted yields may vary depending on the images that you are printing, the paper type that you are using, the frequency of your prints and environmental conditions such as temperature.
- Do not use the cartridges that came with the printer as replacement cartridges.
- To maintain optimum print head performance, some ink is consumed from all ink cartridges during maintenance operations. Ink may also be consumed when you replace an ink cartridge or turn the printer on.
- When printing in monochrome or grayscale, color inks may be used instead of black ink depending on the paper type or print quality settings you are using.

Parent topic: [Replacing Ink Cartridges and Maintenance Boxes](#)

Check Cartridge and Maintenance Box Status

Your product and its software will let you know when an ink cartridge is low or expended, or when the maintenance box needs to be replaced.

[Checking Cartridge and Maintenance Box Status on the LCD Screen](#)

[Checking Cartridge and Maintenance Box Status - Windows](#)

[Checking Cartridge and Maintenance Box Status - Mac](#)

Parent topic: [Replacing Ink Cartridges and Maintenance Boxes](#)

Checking Cartridge and Maintenance Box Status on the LCD Screen

You can check the status of the cartridges and maintenance box using your product's LCD screen.

Press the  supply status icon. You see a screen like this:

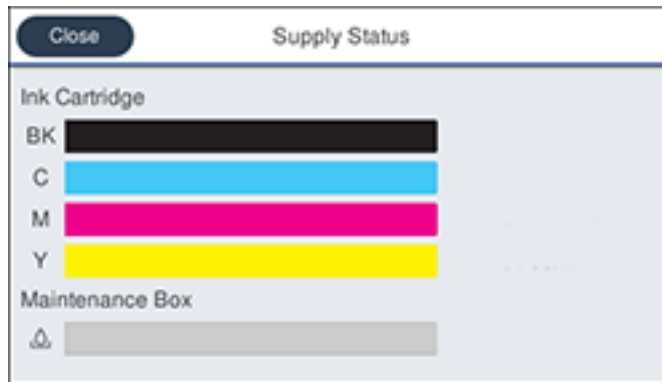

Note: The displayed ink and maintenance box levels are approximate.

Parent topic: [Check Cartridge and Maintenance Box Status](#)

Related tasks



[Removing and Installing Ink Cartridges](#)

[Replacing the Maintenance Box](#)

Checking Cartridge and Maintenance Box Status - Windows

A low ink reminder appears if you try to print when ink is low, and you can check your cartridge or maintenance box status at any time using a utility on your Windows computer.

Note: You can continue printing while the low ink message is displayed. Replace the ink cartridges when required.

1. To check your status, access the Windows Desktop and double-click the  icon for your product in the right side of the Windows taskbar, or click the up arrow and double-click . Then click **Details**.

You see this window:



2. Replace or reinstall the maintenance box or any ink cartridge as indicated on the screen.

Note: If any of the cartridges installed in the product is broken, incompatible with the product model, or improperly installed, Epson Status Monitor will not display an accurate cartridge status.

3. To disable the low ink reminder, right-click the product icon in the Windows taskbar and select **Monitoring Preferences**.

You see this window:

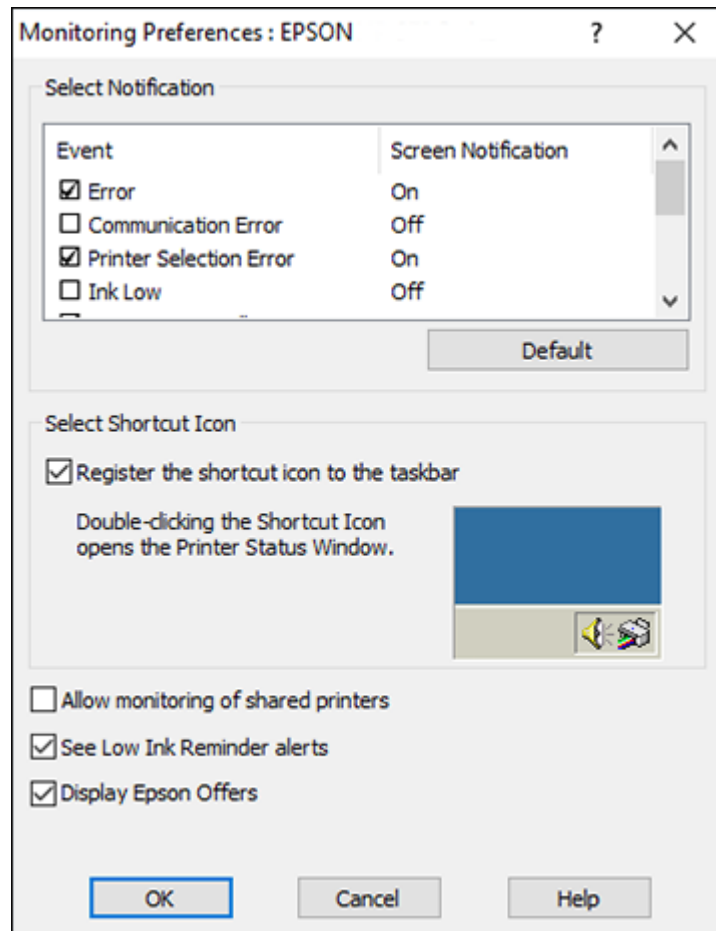

4. Deselect the **See Low Ink Reminder alerts** checkbox at the bottom of the screen.
5. To disable promotional offers, deselect the **Display Epson Offers** checkbox.
6. Click **OK**.

Parent topic: [Check Cartridge and Maintenance Box Status](#)

Related tasks

[Removing and Installing Ink Cartridges](#)

[Replacing the Maintenance Box](#)

Checking Cartridge and Maintenance Box Status - Mac

You can check the status of your ink cartridges and maintenance box using a utility on your Mac.

Note: You can continue printing while the low ink message is displayed. Replace the ink cartridges when required.

1. In the Apple menu or the Dock, select **System Preferences**. Select **Print & Fax**, **Print & Scan**, or **Printers & Scanners**, select your product, and select **Options & Supplies**. Select **Utility** and select **Open Printer Utility**.
2. Select **EPSON Status Monitor**.

You see this window:

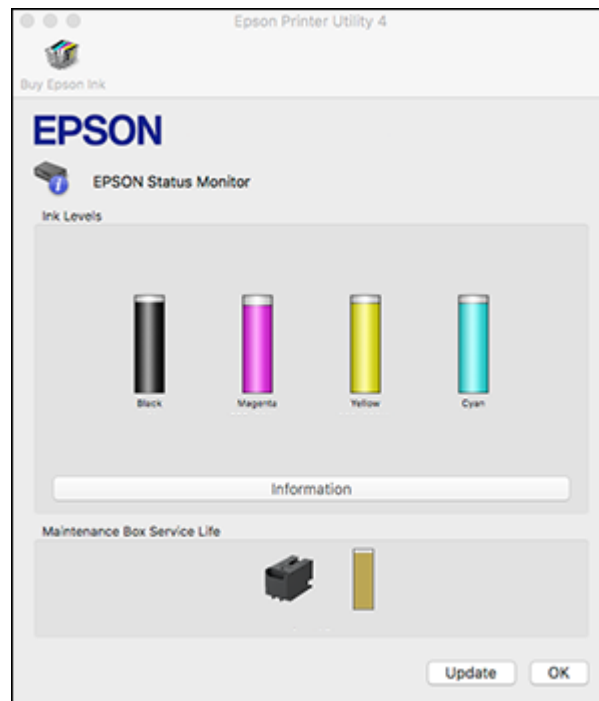

3. Do the following as necessary:
 - You can update the ink cartridge and maintenance box status by clicking **Update**.
 - Replace or reinstall the maintenance box or any ink cartridge as indicated on the screen.

Note: If any of the cartridges installed in the product is broken, incompatible with the product model, or improperly installed, Epson Status Monitor will not display an accurate cartridge status.

Parent topic: [Check Cartridge and Maintenance Box Status](#)

Related tasks

[Removing and Installing Ink Cartridges](#)

[Replacing the Maintenance Box](#)

Purchase Epson Ink Cartridges and Maintenance Box

You can purchase genuine Epson ink, maintenance boxes, and paper at epson.com (U.S. sales) or epson.ca (Canadian sales). You can also purchase supplies from an Epson authorized reseller. To find the nearest one, call 800-GO-EPSON (800-463-7766) in the U.S. or 800-807-7766 in Canada.

Note: Your printer is designed to work only with genuine Epson-brand ink cartridges. Other brands of ink cartridges and ink supplies are not compatible and, even if described as compatible, may not function properly or at all. Epson periodically provides firmware updates to address issues of security, performance, minor bug fixes and ensure the printer functions as designed. These updates may affect the functionality of third-party ink. Non-Epson branded or altered Epson cartridges that functioned prior to a firmware update may not continue to function.

The included initial cartridges are designed for reliable printer setup and cannot be used as replacement cartridges or resold. After setup, the remaining ink is available for printing. Yields are based on ISO 24711 in default mode, printing continuously. Yields vary due to print images, settings, and temperatures. Printing infrequently or primarily with one color reduces yields. All cartridges must be installed with ink for printing and printer maintenance. For print quality, some ink remains in replaced cartridges.

[Ink Cartridge and Maintenance Box Part Numbers](#)

Parent topic: [Replacing Ink Cartridges and Maintenance Boxes](#)

Ink Cartridge and Maintenance Box Part Numbers

Use these part numbers when you order or purchase a new maintenance box or ink cartridges.

Maintenance box part number: T6715

Note: For best printing results, use up a cartridge within 6 months of opening the package.

Ink color	Part number	
	Standard-capacity	High-capacity
Black	924120	924XL120
Cyan	924220	924XL220
Magenta	924320	924XL320
Yellow	924420	924XL420

Parent topic: [Purchase Epson Ink Cartridges and Maintenance Box](#)

Removing and Installing Ink Cartridges

Make sure you have your replacement cartridges handy before you begin. You must install new cartridges immediately after removing the old ones.

Caution: Leave your old cartridges in the printer until you are ready to replace them to prevent the print head nozzles from drying out. Do not open ink cartridge packages until you are ready to install the ink. Cartridges are vacuum packed to maintain reliability.

1. Turn on your product.
 - If an ink cartridge is expended, you see a message on the LCD screen. Note which cartridges need to be replaced and select **How to**.
 - If you are replacing a cartridge before you see a message on the LCD screen, press the  home button if necessary, and select **Maintenance > Ink Cartridge(s) Replacement > Start**.

2. Lift up the scanner unit until it clicks.

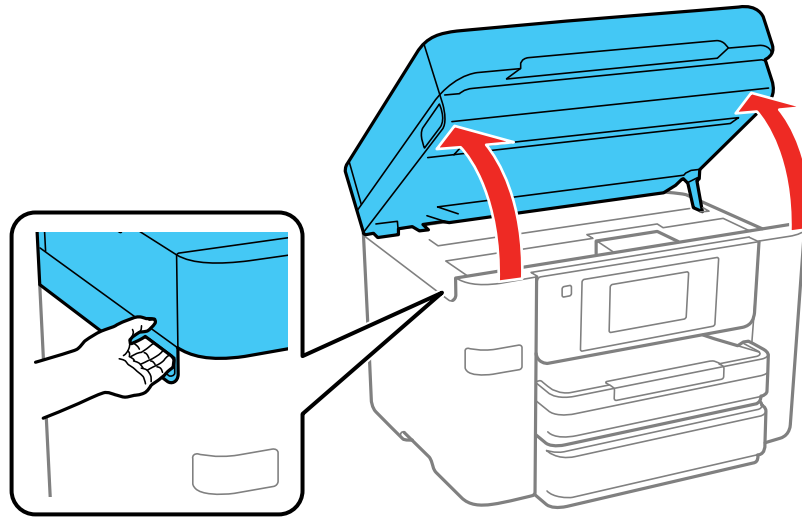

The ink cartridge holder moves to the replacement position. If the ink cartridge holder returns to the home position (far right), repeat steps 1 and 2.

Caution: Do not move the print head by hand or use any kind of tool to remove a cartridge; otherwise, you may damage your product. Do not touch the flat white cable inside the printer.

3. Squeeze the tab on the cartridge and lift the cartridge straight up to remove it.

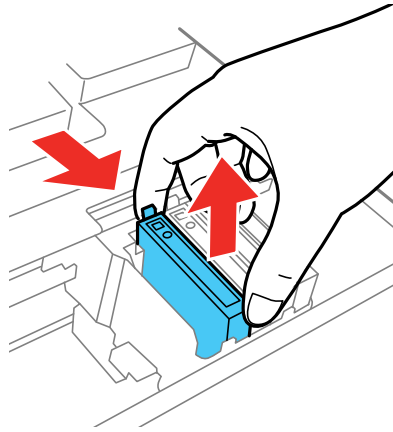

Note: Dispose of used cartridges carefully. Do not take the used cartridge apart or try to refill it.

Warning: If ink gets on your skin, wash it thoroughly with soap and water. If ink gets into your eyes, flush them immediately with water. If ink gets into your mouth, spit it out and see a doctor right away. Keep ink cartridges out of the reach of children.

4. Before opening the new cartridge package, shake it gently four or five times.

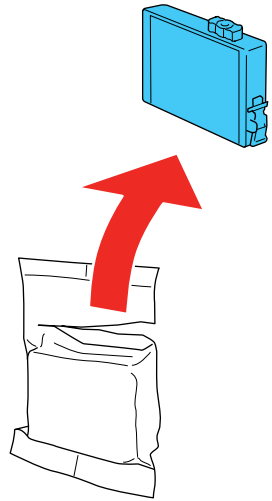

Caution: Do not shake the cartridges after opening the packages, or ink may leak.

5. Remove the cartridge from the package.

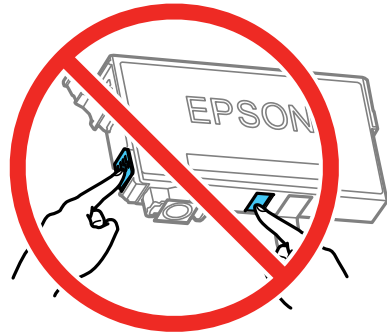

Caution: Do not touch the green chip on the cartridge. Install the new cartridge immediately after removing the old one; if you do not, the print head may dry out and be unable to print.

6. Remove the yellow tape from the base of the cartridge.

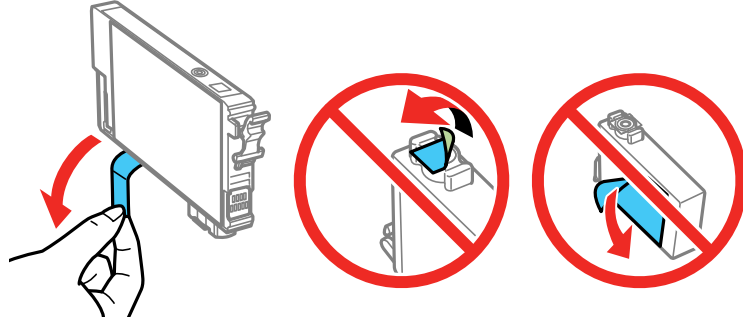

Caution: Do not remove any other labels or seals, or ink will leak.

7. Insert the new cartridge into the holder and push it down until it clicks into place.

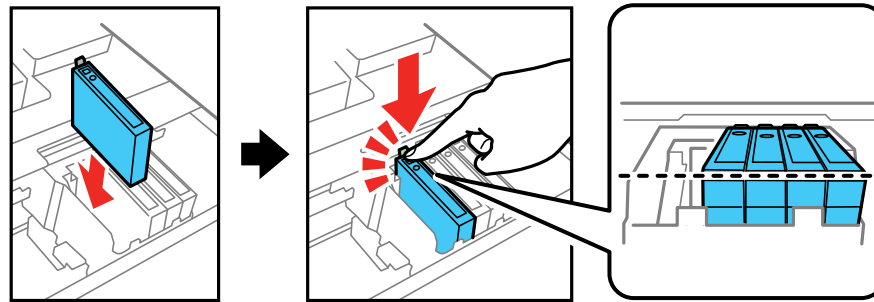

8. Lower the scanner unit and select **Completed** on the LCD screen.

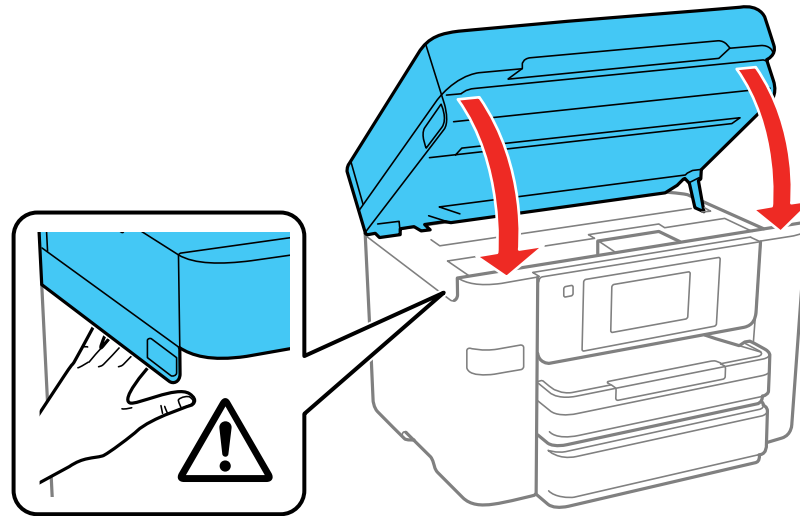

The print head moves to its home position and the printer starts charging the ink. This takes about 90 seconds. When you see a confirmation message on the screen, ink charging is finished.

Caution: Never turn off the product while the power light is flashing or you will waste ink.

If you see an error screen telling you an ink cartridge is installed incorrectly, lift up the scanner unit and press the ink cartridge down until it clicks into place. When you're finished, select **OK**.

If you remove a low or expended ink cartridge, you cannot re-install and use the cartridge.

Caution: If you remove an ink cartridge for later use, protect the ink supply area from dirt and dust and store it in the same environment as the printer. The valve in the ink supply port is designed to contain any excess ink, but do not touch the ink supply port or surrounding area. Always store ink cartridges with the label facing up; do not store cartridges upside-down.

Parent topic: [Replacing Ink Cartridges and Maintenance Boxes](#)

Related concepts

[Purchase Epson Ink Cartridges and Maintenance Box](#)

Printing with Black Ink and Expended Color Cartridges

When a color ink cartridge is expended, you can temporarily continue printing from your computer using black ink. Replace the expended color cartridge as soon as possible for future printing.

Note: You cannot print with expended color ink cartridges using your product's control panel.

[Printing with Expended Color Cartridges - Windows](#)

[Printing with Expended Color Cartridges - Mac](#)

Parent topic: [Replacing Ink Cartridges and Maintenance Boxes](#)

Printing with Expended Color Cartridges - Windows

If you see a message during printing telling you that you can temporarily print in black ink with an expended color cartridge, you can cancel your print job and select print settings.

You can print with an expended color cartridge on the following types of paper:

- Plain paper
- Pre-printed paper
- Letterhead
- Color paper
- Recycled paper
- High-quality plain paper
- Thick paper
- Envelopes

Note: If you are using your Epson product with the Windows 10 S operating system, you cannot use the software described in this section. You also cannot download and install any Epson product software from the Epson website for use with Windows 10 S; you must obtain software only from the Windows Store.

Note: To use this feature, Epson Status Monitor must be enabled.

1. Click **Cancel** or **Cancel Print** to cancel your print job.

Note: If the message screen appears on another computer on a network, you may need to cancel the print job using the product control panel.

2. Load one of the paper types listed above in your product.
3. Access the print settings in your print application.
4. Click the **Main** tab and make sure **Borderless** is not selected.
5. Select a paper type that supports **Print in Black**.
6. Select the **Black/Grayscale** Color setting.
7. Click **OK**.
8. Print your document.
Epson Status Monitor 3 displays a print message.
9. Click **Print in Black** to print your document.

Parent topic: [Printing with Black Ink and Expended Color Cartridges](#)

Printing with Expended Color Cartridges - Mac

If printing stops, you can cancel your print job and select settings to temporarily print with only black ink on plain paper or on an envelope.

The following paper types support printing with expended color cartridges:

- Plain paper
- Pre-printed paper
- Letterhead
- Color paper
- Recycled paper
- High-quality plain paper
- Thick paper
- Envelopes

1. Click the printer icon in the Dock.

2. If you see a message telling you that you can temporarily print with only black ink, click the **Delete** or  button to cancel your print job. If you see an error message, click **OK**.

Note: If the message screen appears on another computer on a network, you may need to cancel the print job using the product control panel.

3. In the Apple menu or the Dock, select **System Preferences**.
4. Select **Print & Fax**, **Print & Scan**, or **Printers & Scanners**, select your product, and select **Options & Supplies**.
5. Select **Driver** or **Options**.

You see a screen like this:

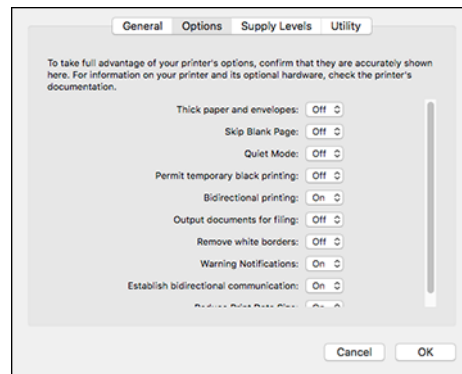

6. Select **On** as the **Permit temporary black printing** setting.
7. Click **OK**.
8. Close the utility window.
9. Load a paper type compatible with temporary black printing in your product.
10. Select **Print Settings** from the pop-up menu.
11. Select a non-borderless paper size as the **Paper Size** setting.
12. Select a paper type that supports **Permit temporary black printing** as the media type setting.
13. Select the **Grayscale** option as the color setting.
14. Click **Print** to print your document.

Parent topic: [Printing with Black Ink and Expended Color Cartridges](#)

Conserving Low Black Ink with Windows

The following window appears when black ink runs low and there is more color ink.

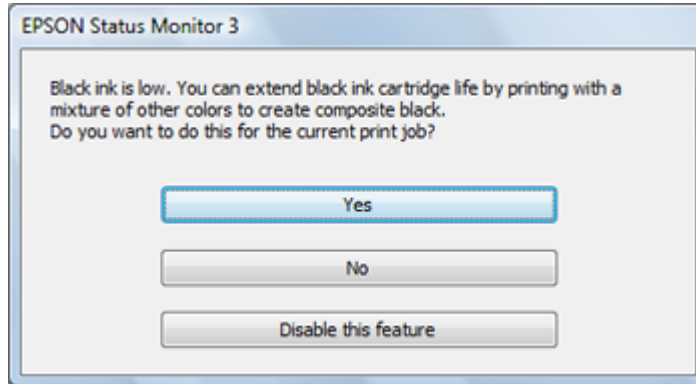

Note: The window appears only when you have selected **Plain Paper/Bright White Paper** as the paper type setting, and depends on other selected print settings. To use this feature, Epson Status Monitor must be enabled.

- Click **Yes** to use a mixture of color inks to create black, or **No** to continue using the remaining black ink for the document you are printing.
- Click **Disable this feature** to continue using the remaining black ink.

Note: If you disable this feature, it remains disabled until you install a new black ink cartridge.

Parent topic: [Replacing Ink Cartridges and Maintenance Boxes](#)

Replacing the Maintenance Box

If the maintenance box is full, a message appears on your product's LCD screen. Select **How To** and follow the steps on the LCD screen to replace the maintenance box. Make sure you have a new maintenance box before you begin.

Note: In some print cycles a small amount of surplus ink may be collected in the maintenance box. To prevent ink leakage from the maintenance box, the product is designed to stop printing when the

absorbing capacity of the maintenance box has reached its limit. Whether and how often this is required will vary according to the number of pages you print, the type of material you print on and the number of cleaning cycles that the printer performs.

Caution: Do not reuse a maintenance box that has been removed and left uninstalled for more than a week. Keep the maintenance box away from direct sunlight.

1. Make sure the product is not printing.
2. Remove the new maintenance box from its package.

Caution: Do not touch the green chip on the maintenance box.

3. Press the tab on the maintenance box cover and remove it.

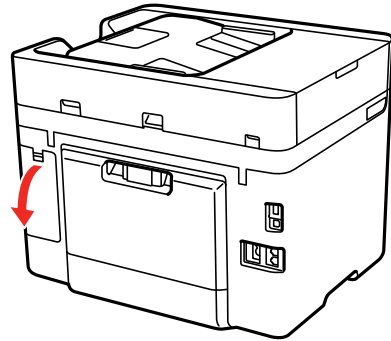

4. Grasp the maintenance box and pull it out of its holder.

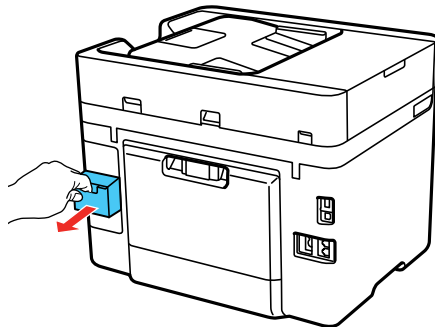

Note: Do not tilt the used maintenance box or take it apart.

Warning: If ink gets on your skin, wash it thoroughly with soap and water. If ink gets into your eyes, flush them immediately with water. If ink gets into your mouth, spit it out and see a doctor right away. Keep the maintenance box out of the reach of children and do not drink the ink.

5. Place the used maintenance box in the plastic bag that came with the new maintenance box. Seal the bag and dispose of it carefully.

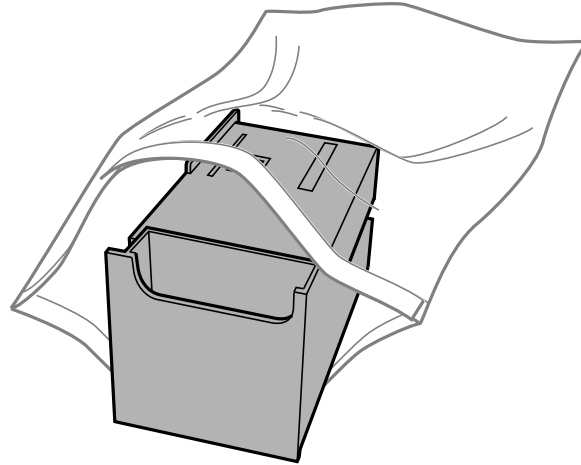

6. Insert the new maintenance box into the holder and push it all the way in.

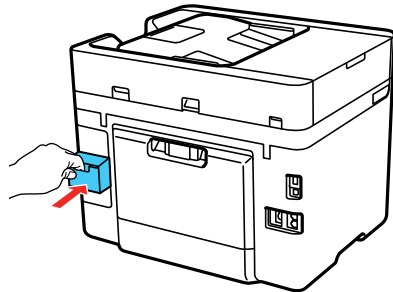

7. Press the tab on the maintenance box cover and reattach it.

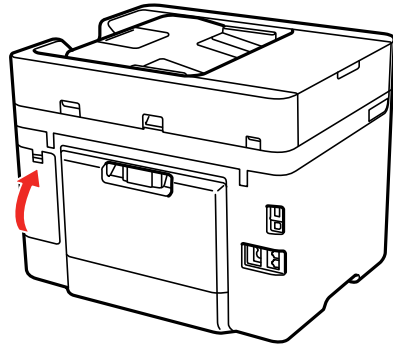

Parent topic: [Replacing Ink Cartridges and Maintenance Boxes](#)

Related concepts

[Purchase Epson Ink Cartridges and Maintenance Box](#)

Adjusting Print Quality

If your print quality declines, you may need to run a utility to clean or align the print head.

Note: If you are using your Epson product with the Windows 10 S operating system, you cannot use the software described in this section. You also cannot download and install any Epson product software from the Epson website for use with Windows 10 S; you must obtain software only from the Windows Store.

If running these utilities does not solve the problem, you may need to replace the ink cartridges.

[Print Head Maintenance](#)

[Aligning the Print Head Using the Product Control Panel](#)

[Adjusting the Print Quality Using the Product Control Panel](#)

[Cleaning the Paper Guide](#)

[Checking the Number of Sheets on the LCD Screen](#)

Print Head Maintenance

If your printouts become too light, or you see dark or light bands across them, you may need to clean the print head nozzles. Cleaning uses ink, so clean the nozzles only if print quality declines.

You can check for clogged nozzles before you clean them so you don't clean them unnecessarily.

Note: You cannot clean the print head if an ink cartridge is expended, and may not be able to clean it when a cartridge is low. You must replace the cartridge first.

[Print Head Nozzle Check](#)

[Print Head Cleaning](#)

Parent topic: [Adjusting Print Quality](#)

Related concepts

[Purchase Epson Ink Cartridges and Maintenance Box](#)

Print Head Nozzle Check

You can print a nozzle check pattern to check for clogged nozzles.

[Checking the Nozzles Using the Product Control Panel](#)

[Checking the Nozzles Using a Computer Utility](#)

Parent topic: [Print Head Maintenance](#)

Checking the Nozzles Using the Product Control Panel

You can check the print head nozzles using the control panel on your product.

1. Make sure there are no errors on the LCD screen.
2. Load a few sheets of plain paper in the product.
3. Press the  home button, if necessary.
4. Select **Settings** > **Maintenance**.
5. Select **Print Head Nozzle Check**.

You see a screen like this:

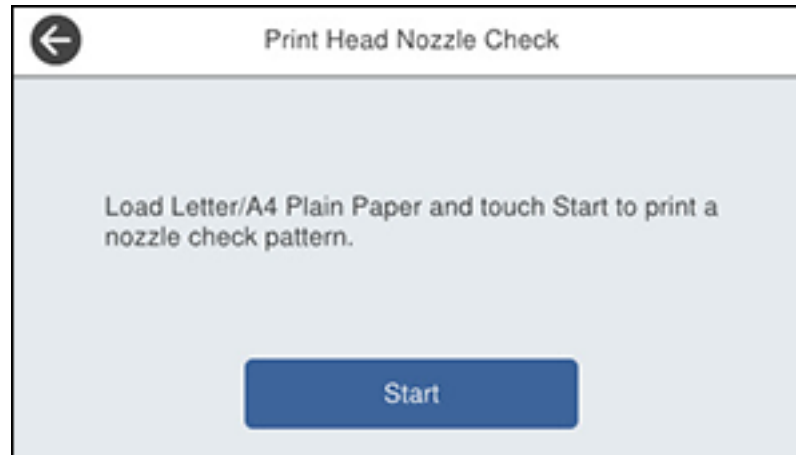

6. Select **Start**.

The nozzle pattern prints.

7. Check the printed pattern to see if there are gaps in the lines.

Print head is clean

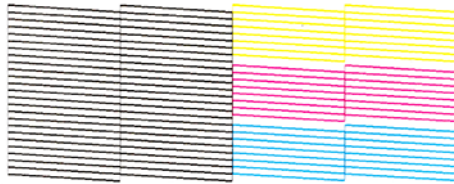

Print head needs cleaning

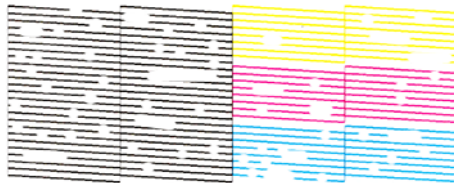

8. Do one of the following:
 - If there are no gaps, select **O**.
 - If there are gaps or the pattern is faint, select **X** and continue.
9. Follow the instructions on the screen to clean the print head, check the nozzles, and repeat the process as necessary.

Caution: Never turn off the product or open the front cover during a cleaning cycle or you may not be able to print.

If you don't see any improvement after cleaning the print head up to 3 times, turn the product off and wait at least 12 hours. Then check the print head nozzles and try cleaning the print head again, if necessary. If quality still does not improve, contact Epson.



Parent topic: [Print Head Nozzle Check](#)

Related concepts

[Print Head Cleaning](#)

Checking the Nozzles Using a Computer Utility

You can check the print head nozzles using a utility on your Windows or Mac computer.

1. Load a few sheets of plain paper in the product.
2. Do one of the following:
 - **Windows:** Access the Windows Desktop and right-click the  icon for your product in the right side of the Windows taskbar, or click the up arrow and right-click .
 - **Mac:** In the Apple menu or the Dock, select **System Preferences**. Select **Print & Fax**, **Print & Scan**, or **Printers & Scanners**, select your product, and select **Options & Supplies**. Select **Utility** and select **Open Printer Utility**.
3. Select **Print Head Nozzle Check**.

You see a window like this:

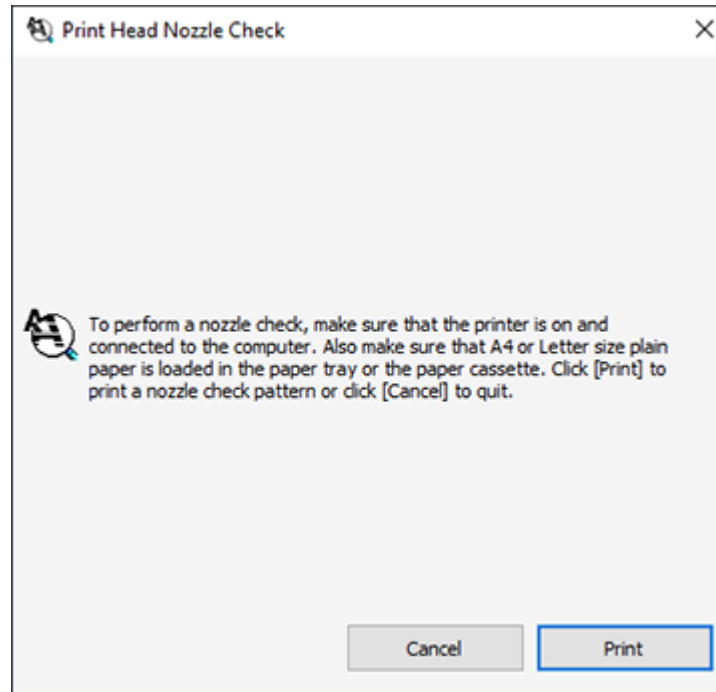

4. Click **Print**.

5. Check the printed pattern to see if there are gaps in the lines.

Print head is clean

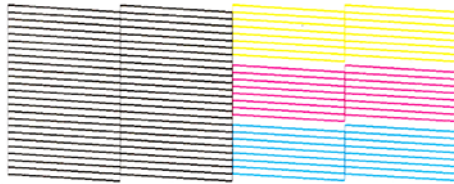

Print head needs cleaning

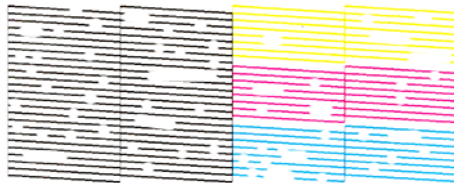

6. Do one of the following:
- If there are no gaps, click **Finish**.
 - If there are gaps or the pattern is faint, clean the print head.

If you don't see any improvement after cleaning the print head up to 3 times, turn the product off and wait at least 12 hours. Then check the print head nozzles and try cleaning the print head again, if necessary. If quality still does not improve, contact Epson.

Parent topic: [Print Head Nozzle Check](#)

Related concepts

[Print Head Cleaning](#)

Print Head Cleaning

If print quality has declined and the nozzle check pattern indicates clogged nozzles, you can clean the print head.

Note: You cannot clean the print head if an ink cartridge is expended, and may not be able to clean it when a cartridge is low. You must replace the cartridge first.

[Cleaning the Print Head Using the Product Control Panel](#)

[Cleaning the Print Head Using a Computer Utility](#)

Parent topic: [Print Head Maintenance](#)

Related concepts

[Purchase Epson Ink Cartridges and Maintenance Box](#)

Related tasks

[Removing and Installing Ink Cartridges](#)

Cleaning the Print Head Using the Product Control Panel

You can clean the print head using the control panel on your product.

1. Make sure there are no errors on the LCD screen.
2. Load a few sheets of plain paper in the product.
3. Press the  home button, if necessary.
4. Select **Maintenance**.

You see a screen like this:

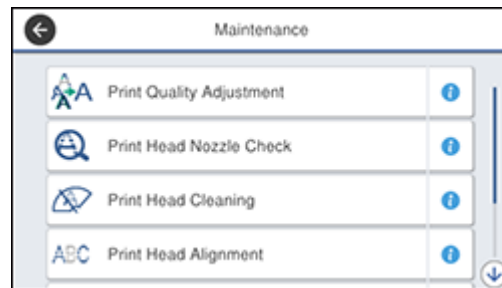

5. Select **Print Head Cleaning**.

You see a screen like this:

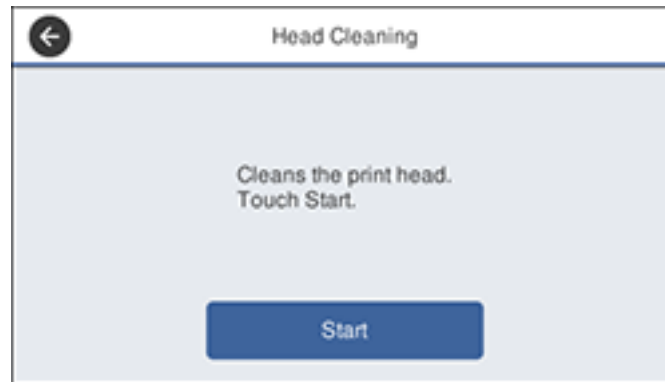

6. Select **Start** to clean the print head.

When the cleaning cycle is finished, you see a message on the screen.

Caution: Never turn off the product or open the front cover during a cleaning cycle or you may not be able to print.

7. Select **Yes**.
8. Select **Start** to confirm that the print head is clean.

If you don't see any improvement after cleaning the print head up to 3 times, turn the product off and wait at least 12 hours. Then check the print head nozzles and try cleaning the print head again, if necessary. If quality still does not improve, contact Epson.

Parent topic: [Print Head Cleaning](#)



Related tasks

[Loading Paper in the Cassette](#)

Cleaning the Print Head Using a Computer Utility

You can clean the print head using a utility on your Windows or Mac computer.

1. Make sure there are no errors on the LCD screen.
2. Load a few sheets of plain paper in the product.

3. Do one of the following:
 - **Windows:** Access the Windows Desktop and right-click the  icon for your product in the right side of the Windows taskbar, or click the up arrow and right-click .
 - **Mac:** In the Apple menu or the Dock, select **System Preferences**. Select **Print & Fax**, **Print & Scan**, or **Printers & Scanners**, select your product, and select **Options & Supplies**. Select **Utility** and select **Open Printer Utility**.
4. Select **Print Head Cleaning**.

You see a window like this:

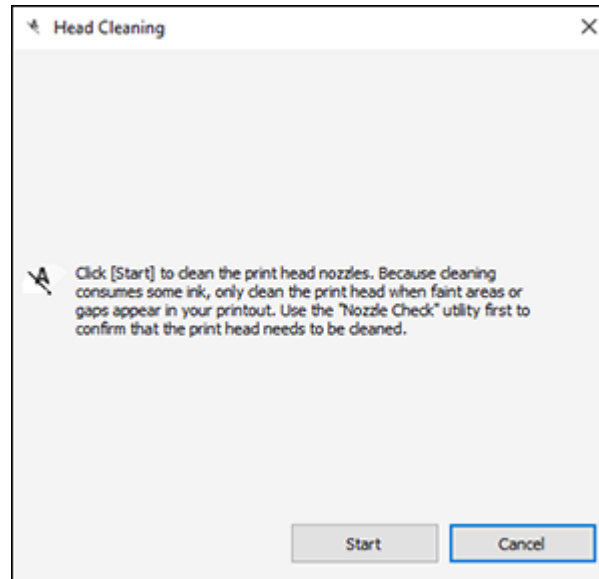

5. Click **Start** to begin the cleaning cycle.

The  power light flashes throughout the cleaning cycle and stays on when the cleaning cycle is finished.
6. When the cleaning cycle is finished, you can check to see if the nozzles are clean; click **Print Nozzle Check Pattern** and click **Print**.

7. Check the printed pattern to see if there are gaps in the lines.

Print head is clean

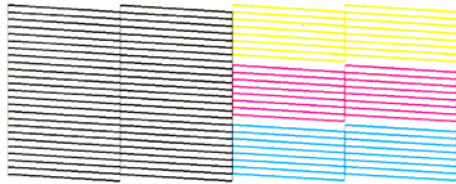

Print head needs cleaning

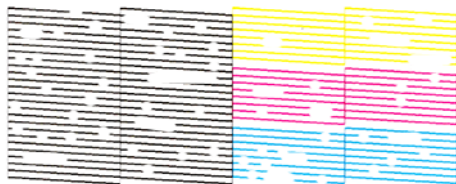

- If there are no gaps, click **Finish**.
- If there are gaps or the pattern is faint, click **Clean** to clean the print head again.

If you don't see any improvement after cleaning the print head up to 3 times, turn off the product and wait at least 12 hours. Then check the print head nozzles and try cleaning the print head again, if necessary. If quality still does not improve, contact Epson.

Parent topic: [Print Head Cleaning](#)

Related tasks

[Loading Paper in the Cassette](#)

Aligning the Print Head Using the Product Control Panel

You can align the print head using the control panel on your product.

1. Make sure there are no errors on the LCD screen.
2. Load a few sheets of plain paper in the product.
3. Press the  home button, if necessary.

4. Select **Maintenance**.

You see a screen like this:



5. Select **Print Head Alignment**.

6. Select one of the following options:

- **Ruled Line Alignment** if vertical lines in your printout are misaligned.
- **Horizontal Alignment** if your printout contains horizontal banding.

7. Follow the on-screen instructions to print an alignment sheet.

Note: Do not cancel printing while you are printing head alignment patterns.

8. Check the printed patterns on the alignment sheet and select the following on the LCD screen, depending on the alignment pattern you printed:

- **Ruled Line Alignment:** For patterns 1 and 2, select the number representing the pattern with the least misaligned vertical line.

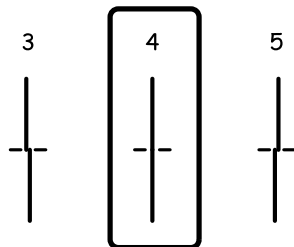

- **Horizontal Alignment:** Select the number representing the pattern with the least amount of separation or overlap.



9. Select **Done**.

Parent topic: [Adjusting Print Quality](#)

Related tasks

[Loading Paper in the Cassette](#)

Adjusting the Print Quality Using the Product Control Panel

You can adjust the print quality using the control panel on your product.

1. Make sure there are no errors on the LCD screen.
2. Load a few sheets of plain paper in the product.
3. Press the  home button, if necessary.
4. Select **Settings** > **Maintenance** > **Print Quality Adjustment**.
5. Follow the on-screen instructions to print an alignment sheet.

Note: Do not cancel printing while you are printing head alignment patterns.

6. Check the printed patterns on the alignment sheet and select number of the best printed pattern for each set:
 - Select the number representing the pattern with the least amount of separation or overlap.

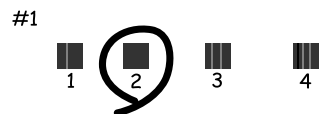

- Select the number representing the pattern with the least misaligned vertical line.

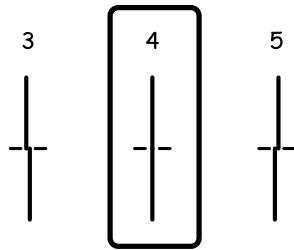

- Select the number representing the pattern with the least amount of separation or overlap.

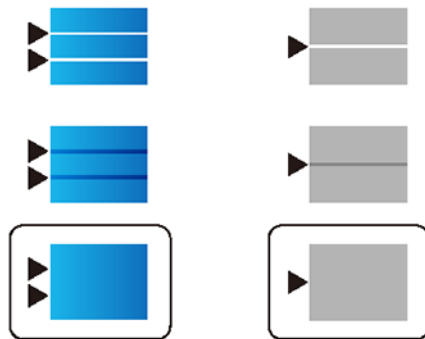

7. Continue following the on-screen instructions to finish the print quality adjustment.

Parent topic: [Adjusting Print Quality](#)

Cleaning the Paper Guide

If you see ink on the back of a printout, you can clean the paper guide rollers to remove any excess ink. If paper does not feed correctly from the rear paper feed slot, you can use a cleaning sheet to clean the rollers.

1. If printouts are smeared or scuffed, load plain paper in the paper source that you want to clean in this size: Letter (8.5 × 11 inches [216 × 279 mm]) or A4 (8.3 × 11.7 inches [210 × 297 mm]).
2. Select **Settings**.

3. Select **Maintenance**.

You see a screen like this:



4. Scroll down and select **Paper Guide Cleaning**.
5. Select the paper source you want to clean, if necessary.
6. Follow the on-screen instructions to clean the paper guide.
7. Repeat these steps as necessary until the paper comes out clean. If you are using a cleaning sheet, repeat these steps up to 3 times.

Note: If the paper is not clean after cleaning several times, try cleaning the other paper sources.

Parent topic: [Adjusting Print Quality](#)

Related tasks

[Loading Paper in the Cassette](#)

[Checking the Number of Sheets on the LCD Screen](#)

Checking the Number of Sheets on the LCD Screen

You can view the number of sheets of paper that have fed through the product on the LCD screen.

1. Press the  home button, if necessary.
2. Select **Settings** > **Print Counter** to view the number of prints (**In Total**, **B&W Prints** and **Color Prints**).
3. Select **Print Sheet** > **Print** if you want to print a record of the number of printed pages.

Parent topic: [Adjusting Print Quality](#)

Related tasks

[Loading Paper in the Cassette](#)

Cleaning and Transporting Your Product

See these sections if you need to clean or transport your product.

[Cleaning Your Product](#)

[Transporting Your Product](#)

Cleaning Your Product

To keep your product working at its best, you should clean it several times a year.

Caution: Do not use a hard brush, alcohol, or paint thinner to clean the product or you may damage it. Do not use oil or other lubricants inside the product or let water get inside it.

1. Turn off the product.
2. Unplug the power cord.
3. Disconnect any connected cables.
4. Pull out the paper cassette and remove the paper.

5. Open the document cover.

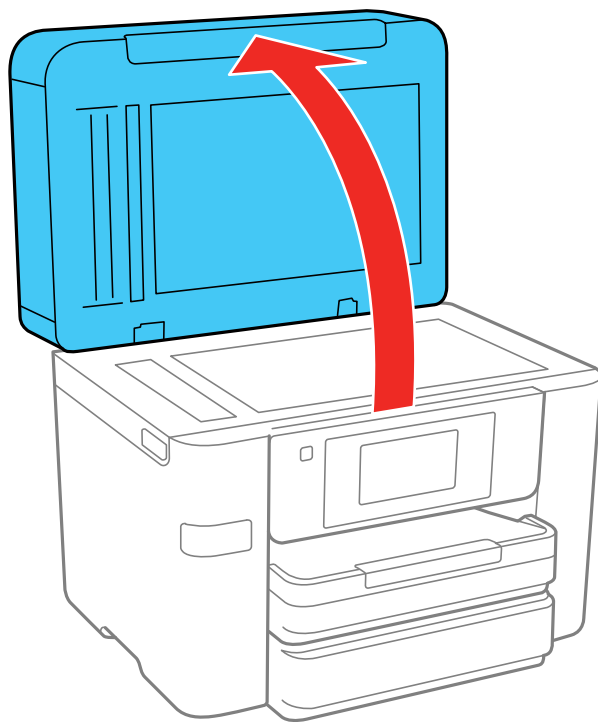

6. Clean the scanner glass and the glass area on the left with a soft, lint-free cloth (microfiber is recommended) moistened with a little glass cleaner.

Caution: Do not spray glass cleaner directly on the glass and do not press the glass surface with any force.

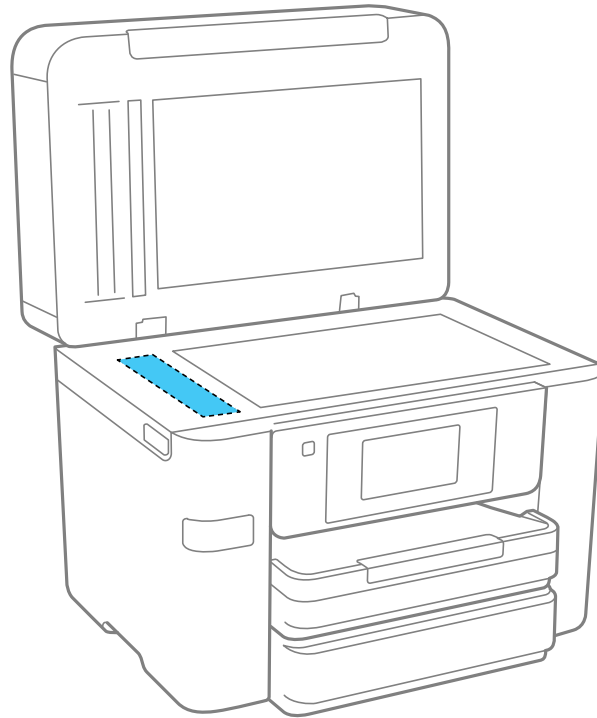

7. Close the document cover.

8. Open the ADF cover.

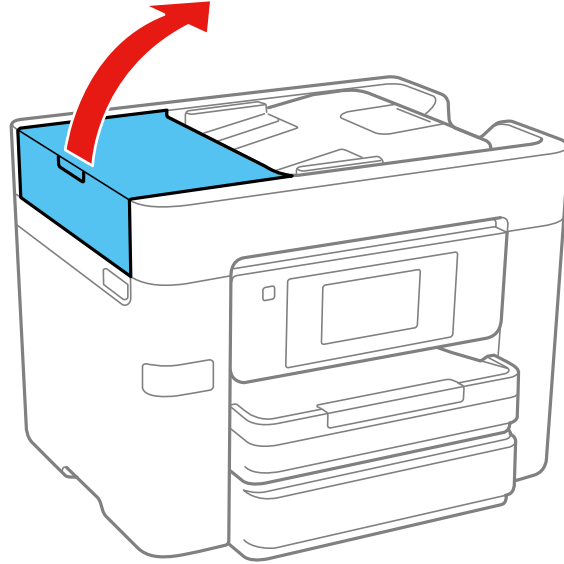

9. Use a soft, moist cloth to clean the rollers and the interior of the ADF.

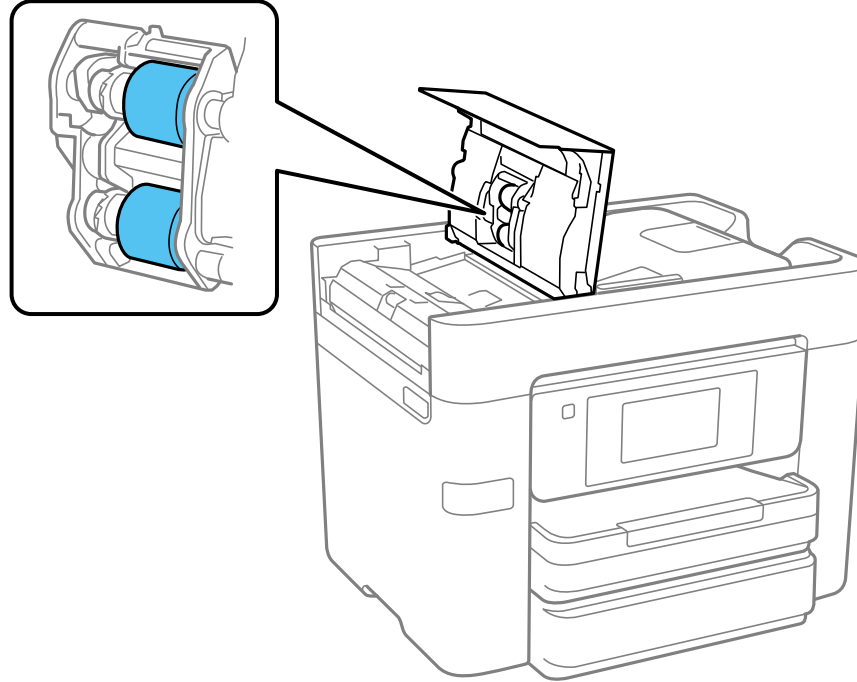

Caution: Using a dry cloth may damage the surface of the rollers. Do not use the ADF until the rollers are dry.

10. Clean the outer case and control panel with a soft, clean, and damp cloth. If there are stubborn stains, use a damp cloth with a mild detergent.

Parent topic: [Cleaning and Transporting Your Product](#)

Transporting Your Product

If you need to store your product or transport it a long distance, prepare it for transportation as described here.

Caution: During transportation and storage, follow these guidelines:

- Avoid tilting the product, placing it vertically, or turning it upside down; otherwise ink may leak.

- Leave the ink cartridges installed. Removing the cartridges can dry out the print head and may prevent the product from printing.
- Do not carry the product by its control panel; this may damage the product.

Note: Before storing your product for a long period, replace low, expended, or expired ink to help prevent the print head from drying out. Store your product in a cool, dry place.

1. Turn off the product.
2. Wait for the  power light to go out, then unplug the power cable.
3. Disconnect any connected cables.
4. Remove all the paper from the product.
5. Close the output tray and paper support.

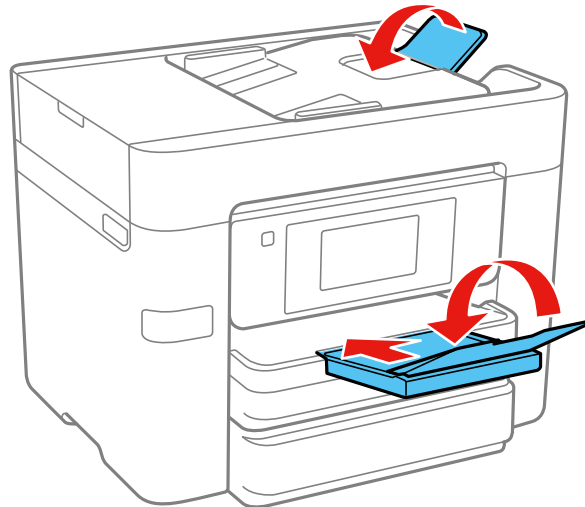

6. Remove any memory device inserted in the product.
7. Lift up the scanner unit and check to see if the print head is in the far right position (the home position). If not, turn on the product, wait for the print head to move, then turn the product off again.

- Secure the ink cartridge holder to the case with tape.

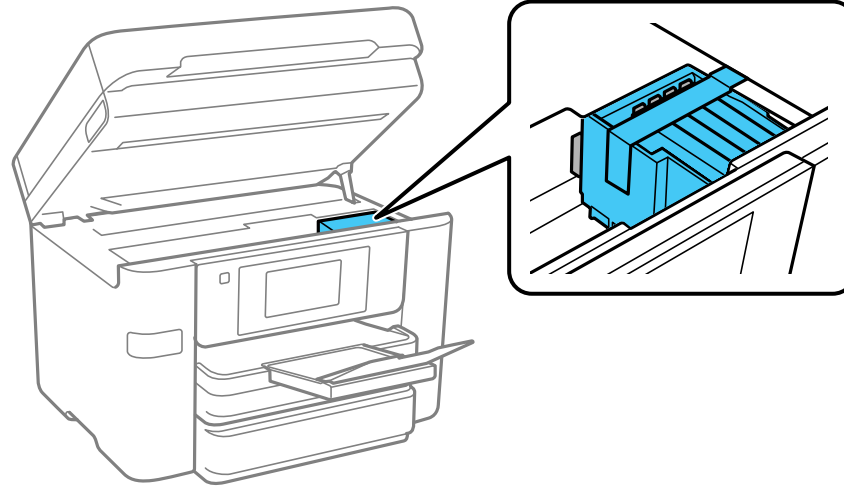

- Lower the scanner unit.
- Lower the control panel.
- Place the product in its original packing materials, if possible, or use equivalent materials with cushioning around the product.

Keep the product level during transportation. Be sure to remove the tape from the ink cartridge holder before turning on your product. If print quality has declined when you print again, clean and align the print head.

Parent topic: [Cleaning and Transporting Your Product](#)

Related concepts

[Print Head Nozzle Check](#)

[Print Head Cleaning](#)

Solving Problems

Check these sections for solutions to problems you may have using your product.

[Viewing the Help Screen](#)

[Checking for Software Updates](#)

[Product Status Messages](#)

[Running a Product Check](#)

[Resetting Control Panel Defaults](#)

[Solving Setup Problems](#)

[Solving Network Problems](#)

[Solving Copying Problems](#)

[Solving Paper Problems](#)

[Solving Problems Printing from a Computer](#)

[Solving Page Layout and Content Problems](#)

[Solving Print Quality Problems](#)

[Solving Scanning Problems](#)

[Solving Scanned Image Quality Problems](#)

[Solving Faxing Problems](#)

[Solving USB Device Problems](#)

[Uninstall Your Product Software](#)

[Where to Get Help](#)

Viewing the Help Screen

You can view troubleshooting or how-to topics on the LCD screen at any time.

1. Select the  help icon.

You see this screen:

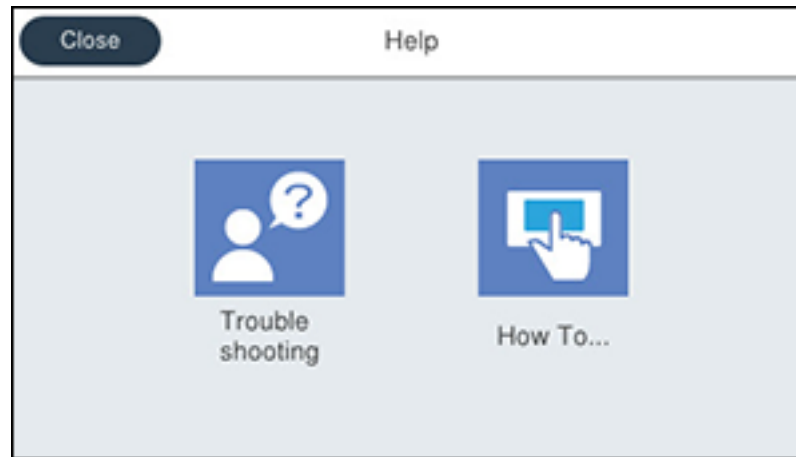



2. Select **Troubleshooting** or **How To** to view instructional images or animations.

Parent topic: [Solving Problems](#)

Checking for Software Updates

It's a good idea to check Epson's support website occasionally for free updates to your product software. Visit epson.com/support (U.S.) or epson.ca/support (Canada) and select your product.

Note: Your printer is designed to work only with genuine Epson-brand ink cartridges. Other brands of ink cartridges and ink supplies are not compatible and, even if described as compatible, may not function properly or at all. Epson periodically provides firmware updates to address issues of security, performance, minor bug fixes and ensure the printer functions as designed. These updates may affect the functionality of third-party ink. Non-Epson branded or altered Epson cartridges that functioned prior to a firmware update may not continue to function.

- **Windows:** Your printer software automatically checks for updates. You can also manually update the software by selecting **Software Update** here:
 - Accessing the Windows Desktop and right-clicking the  icon for your product in the right side of the Windows taskbar, or clicking the up arrow and right-clicking .
 - On the **Maintenance** tab in the printer settings window

You can also update the software by selecting **EPSON Software Updater** in the **EPSON** or **Epson Software** program group, accessible by the **Start** button, or on the **Start** or **Apps** screens, depending on your version of Windows.

- **OS X:** You can manually update the software by opening the **Applications > Epson Software** folder and selecting **EPSON Software Updater**.
- **macOS 10.12.x, 10.13.x, 10.14.x, 10.15.x, 11.x, or 12.x:** You can manually update the software by opening the **App Store**, selecting **Updates**, searching for a software update option for Epson Software, and selecting **Update**.

Parent topic: [Product Basics](#)
[Solving Problems](#)

Product Status Messages

You can often diagnose problems with your product by checking the messages on its LCD screen.

Note: If the screen is dark, press the screen to wake the product from sleep mode.

LCD screen message	Condition/solution
Printer error. Turn the power off and on again. If the problem persists, contact Epson Support.	Turn the product off and then back on again. If the error persists, check for and remove any jammed paper or protective materials from the product. If the error still persists, contact Epson for support.
Printer error. Contact Epson Support. Non-printing features are available.	The printer may be damaged. Contact Epson for support. Non-printing features such as scanning are still available.
Printer error. For details, see your documentation.	The printer may be damaged. Contact Epson for support.
Paper out in XX. Load paper. Paper Size: XX/ Paper Type: XX	Load paper in the empty paper cassette. Make sure to insert the paper cassette all the way until it stops.
You need to replace Ink Cartridge	Replace the indicated ink cartridges.
The printer's borderless printing ink pad is nearing the end of its service life. It is not a user-replaceable part. Please contact Epson Support.	The ink pads are near the end of their service life and the message will be displayed until the ink pad is replaced. Contact Epson to replace ink pads before the end of their service life.

LCD screen message	Condition/solution
The printer's borderless printing ink pad has reached the end of its service life. It is not a user-replaceable part. Please contact Epson Support.	The ink pad is at the end of its service life. Turn off the product and contact Epson for support.
Paper Setup Auto Display is set to Off. Some features may not be available. For details, see your documentation.	AirPrint is not available when the Paper Setup Auto Display setting is disabled. Change the Paper Setup Auto Display setting to On .
No dial tone is detected.	Make sure the phone cable is connected correctly and the phone line works. If you connected the product to a PBX (Private Branch Exchange) phone line or Terminal Adapter, change the Line Type setting to PBX . If you still cannot send a fax, turn off the Dial Tone Detection setting. (Turning off the Dial Tone Detection setting may cause the product to drop the first digit of a fax number.)
The combination of the IP address and the subnet mask is invalid. See your documentation for more details	There is a problem with the network connection to your product. Set up your product on the network again.
To use cloud services, update the root certificate from the Epson Web Config utility	Access the Web Config utility and update the cloud service root certificate.
Check that the printer driver is installed on the computer and that the port settings for the printer are correct.	Make sure the printer port is correctly configured. In Windows, make sure the port is set to a USBXXX setting for a USB connection or EpsonNet Print Port for a network connection.
Recovery mode Update Firmware	An error has occurred during firmware updating. Connect your product using a USB cable and try downloading the Firmware Update from Epson's support website. If you still need help, contact Epson for support.

LCD screen message	Condition/solution
DNS error. Check DNS settings.	<p>A communication error during scanning to a shared folder over a network has occurred. Try the following:</p> <ul style="list-style-type: none"> • Make sure the computer you are scanning to is turned on and not in sleep mode. • Temporarily disable the computer's firewall and security software, then try saving a scan over the network again. If successful, check your security software settings. • Check the computer's network type to make sure it is not set to Public; you cannot save a scan to a shared folder over a public network. Click the link to "Cannot Save a Scan to a Shared Folder Over a Network" below for instructions. • Make sure the shared folder path matches the path registered to your product contacts list. • Make sure the IP address of the computer is correct. If using DHCP, obtain the IP address again. If using a static IP address, change the computer name in the shared folder path to the IP address and try again. (For example, change \\EPSON02\SCAN to \\192.168.xxx.xxx\SCAN) • Make sure the DNS setting is correct, and that the computer name and IP address match when the DNS server management table is updated. Contact your network administrator.
Authentication error. Check the authentication method, authenticated account, and authenticated password.	<p>An authentication error during scanning to a shared folder over a network has occurred. Make sure the computer's user name and password are correct and match those registered to your product contacts list. Also make sure the password has not expired.</p>

LCD screen message	Condition/solution
Communication error. Check the Wi-Fi/network connection.	<p>A wireless communication error during scanning to a shared folder over a network has occurred. Try the following:</p> <ul style="list-style-type: none"> • Make sure the path to the shared folder matches the path registered to your product's contact list. • Make sure you enabled access rights to the shared folder in the folder Properties when you created the shared folder. See the link below for instructions on creating a shared folder using the correct properties. • Windows: Make sure the Use Microsoft network sharing setting is enabled in Web Config. Select Network > MS Network to access the setting. See the link below for instructions on accessing Web Config.
The file name is already in use. Rename the file and scan again.	A file of the same name already exists in the shared network folder you are trying to scan to. Change the filename, or move or deleted files as necessary and try scanning to the shared folder again.
Scanned file(s) are too large. Only XX pages have been sent. Check if the Location has enough space.	The storage on the computer you are trying to scan to does not have enough space to store your scan. Increase the free space and try again.

Note: In some print cycles a very small amount of surplus ink may be collected in the borderless printing ink pad. To prevent ink leakage from the pad, the product is designed to stop borderless printing when the pad has reached its limit. Whether and how often this is required will vary according to the number of pages you print using the borderless print option. The need for replacement of the pad does not mean that your printer has ceased to operate in accordance with its specifications. The printer will advise you when the pad requires replacing and this can only be performed by an authorized Epson Service provider. The Epson warranty does not cover the cost of this replacement.

Parent topic: [Solving Problems](#)

Related references

[Cannot Save a Scan to a Shared Folder Over a Network](#)

Related tasks

[Checking for Software Updates](#)

[Connecting a Telephone or Answering Machine](#)

[Using AirPrint](#)
[Creating a Shared Network Folder](#)
[Accessing the Web Config Utility](#)
[Selecting the Line Type](#)

Related topics

[Solving Paper Problems](#)
[Wi-Fi or Wired Networking](#)

Running a Product Check

Running a product check helps you determine if your product is operating properly.

1. Disconnect any interface cables connected to your product.
2. Load plain paper in the product.
3. Press the  home button, if necessary.
4. Select **Maintenance**.

You see a screen like this:



5. Select **Print Head Nozzle Check**.

You see a screen like this:



6. Select **Start**.
The nozzle pattern prints.
7. Do one of the following, depending on the results of the product check:
 - If the page prints and the nozzle check pattern is complete, the product is operating properly. Any operation problem you may have could be caused by your computer, cable, software, or selected settings. Check the other solutions in this book or try uninstalling and reinstalling your printer software.
 - If the page prints but the nozzle check pattern has gaps, clean the print head.
 - If the page does not print, the product may have a problem. Check the other solutions in this manual. If they do not work, contact Epson.

Parent topic: [Solving Problems](#)

Related concepts

[Uninstall Your Product Software](#)

[Print Head Cleaning](#)

Related tasks

[Aligning the Print Head Using the Product Control Panel](#)

Resetting Control Panel Defaults

If you have a problem with settings on the product control panel, you can reset them to their factory defaults. You can choose which settings to reset or reset them all.

Note: This setting can be locked by an administrator. If you cannot access or change this setting, contact your administrator for assistance.

1. Press the  home button, if necessary.
2. Select **Settings > General Settings > System Administration**.
3. Select **Restore Default Settings**.

You see a screen like this:



4. Select one of these options:
 - **Network Settings:** Resets all network settings
 - **Copy Settings:** Resets all settings for copying
 - **Scan Settings:** Resets all settings for scanning
 - **Fax Settings:** Resets all settings for faxing
 - **Clear All Data and Settings:** Resets all control panel settings including the contacts list

You see a confirmation screen.

5. Select **Yes** to reset the selected settings. (Select **No** if you want to cancel the operation.)

Parent topic: [Solving Problems](#)

Solving Setup Problems

Check these sections if you have problems while setting up your product.

[Product Does Not Turn On or Off](#)

[Noise After Ink Installation](#)

[Software Installation Problems](#)

Parent topic: [Solving Problems](#)

Product Does Not Turn On or Off

If you cannot turn the product on or off, try these solutions:

- If you cannot turn on your product, make sure the power cord is securely connected and hold down the power button a little longer.
- If you cannot turn off your product, hold down the power button a little longer. If you still cannot turn off your product, unplug the power cord, plug the power cord back in, then turn your product on and off again using the power button.

Parent topic: [Solving Setup Problems](#)

Noise After Ink Installation

If you hear noises from your product after installing ink, check the following:

- The first time you install the ink cartridges, the product must charge its print head. Wait until charging finishes before you turn off the product, or it may charge improperly and use excess ink the next time you turn it on.
- If the product's print head stops moving or making noise, and the charging process has not finished after approximately 5 minutes, turn off your product. Turn it back on and check to see if charging is still in progress. If it is still in progress, contact Epson for help.

Parent topic: [Solving Setup Problems](#)

Software Installation Problems

If you have problems while installing your product software, try these solutions:

- Make sure your product is turned on and any necessary cables are securely connected at both ends. If you still have problems installing software, disconnect the cable and carefully follow the instructions on the *Start Here* sheet. Also make sure your system meets the requirements for your operating system.
- Close any other programs, including screen savers and virus protection software, and install your product software again.
- In Windows, make sure your product is selected as the default printer and the correct port is shown in the printer properties.

- If you see any error message or your software does not install correctly in Windows, you may not have software installation privileges. Contact your system administrator.

Parent topic: [Solving Setup Problems](#)

Related concepts

[Uninstall Your Product Software](#)

Related references

[Windows System Requirements](#)

[Mac System Requirements](#)

Solving Network Problems

Check these solutions if you have problems setting up or using your product on a network.

Note: Breakdown or repair of this product may cause loss of fax and network data and settings. Epson is not responsible for backing up or recovering data and settings during or after the warranty period. We recommend that you make your own backup or print out your fax and network data and settings.

[Product Cannot Connect to a Wireless Router or Access Point](#)

[Network Software Cannot Find Product on a Network](#)

[Product Does Not Appear in Mac Printer Window](#)

[Wireless Network Connection is Unstable on a Mac](#)

[Wired Network Connection Becomes Unstable](#)

[Cannot Print Over a Network](#)

[Cannot Scan Over a Network](#)

Parent topic: [Solving Problems](#)

Product Cannot Connect to a Wireless Router or Access Point

If your product has trouble finding or connecting to a wireless router or access point, try these solutions:

- If you are connecting the product via Wi-Fi Protected Setup (WPS) and the Wi-Fi icon on your product's LCD screen is not lit or does not appear, make sure you select one of the WPS options from the product control panel within 2 minutes of pressing the WPS button on your router.
- Make sure to place your product within contact range of your router or access point. Avoid placing your product near a microwave oven, cordless phone, or large metal object, such as a filing cabinet.
- Verify that your router or access point is operating correctly by connecting to it from your computer or another device.

- Print a network connection report and check the codes and messages on the report to help determine the cause of the problem.
- You may need to disable the firewall and any anti-virus software on your wireless router or access point.
- Try restarting your router following the instructions in your router documentation.

Note: If you are reading these instructions online, you will lose your Internet connection when you restart your router.

- Check to see if access restrictions, such as MAC address filtering, are set on the router or access point. If access restrictions are set, add your product's MAC address to your router's address list. To obtain your product's MAC address, print a network status sheet. Then follow the instructions in your router or access point documentation to add the address to the list.
- If your router or access point does not broadcast its network name (SSID), follow the instructions that came with your product to enter your wireless network name manually.
- If your router or access point has security enabled, determine the kind of security it is using and any required password or passphrase for connection. Then make sure to enter the exact WEP key or WPA passphrase correctly.
- Check if your computer is restricting the available wireless channels. If so, verify that your wireless access point is using one of the usable channels and change to a usable channel, if necessary.
- If you cannot connect your product to a device using Wi-Fi Direct, you may have exceeded the maximum number of devices connected to your product (8). Print a network status sheet or access Web Config on the browser for your device and check the number of connected devices. If 8 devices are already connected, disconnect a device by deleting the product's SSID from the Wi-Fi screen of that device. If fewer than 8 devices are connected, check the accuracy of your other network settings, move your device closer to your product, and try connecting again.

Parent topic: [Solving Network Problems](#)

Related tasks

[Selecting Wireless Network Settings from the Control Panel](#)

[Enabling Wi-Fi Direct Mode](#)

[Printing a Network Status Sheet](#)

[Printing a Network Connection Report](#)

Related topics

[Wi-Fi or Wired Networking](#)

Network Software Cannot Find Product on a Network

If EpsonNet Setup cannot find your product on a network, try these solutions:

- Make sure your product is turned on and connected to your network. Verify the connection using your product control panel.
- Check if your network name (SSID) contains non-ASCII characters. Your product cannot display non-ASCII characters.
- Print a network connection report and check the codes and messages on the report to help determine the cause of the problem.
- Make sure your product is not connected to a guest network.
- If necessary, reinstall your product software and try running EpsonNet Setup again:
 1. Reset your product's network settings to their factory defaults.
 2. **Windows only:** Uninstall your product software.
 3. Restart your router following the instructions in your router documentation.

Note: If you are reading these instructions online, you will lose your Internet connection when you restart your router, so note the next step before restarting it.

4. Download your product software from the Epson website using the instructions on the *Start Here* sheet.
- If you have replaced your router, reinstall your product software to connect to the new router.
 - Check to see if your wireless router or access point has an enabled Privacy Separator function that is preventing detection of your device over the network. See your router or access point documentation for instructions on disabling the Privacy Separator function.

Parent topic: [Solving Network Problems](#)

Product Does Not Appear in Mac Printer Window

If your product does not appear in the Mac printer window, try these solutions:

- Turn your product off, wait 30 seconds, then turn it back on again.
- If you are connecting the product via Wi-Fi Protected Setup (WPS) and the Wi-Fi icon on your product's LCD screen is not lit, make sure you select one of the WPS options from the product control panel within 2 minutes of pressing the WPS button on your router.

- If you are connecting the product wirelessly via EpsonNet Setup and the Wi-Fi icon does not appear on your LCD screen, make sure your product software was installed correctly. If necessary, reinstall your software.

Parent topic: [Solving Network Problems](#)

Wireless Network Connection is Unstable on a Mac

If you connected a device to a USB 3.0 port on your Mac, you may experience wireless network interference between your product and your Mac.

If you cannot connect to your product over the wireless network or the connection becomes unstable, move the device connected to your Mac USB 3.0 port further away from your Mac.

If your wireless router or access point has a 5 GHz band, connect to it (U.S. and Canada only).

Note for U.S. and Canada: If your router uses a single network name (SSID) for both the 2.4 GHz and 5 GHz band, give each band its own network name (SSID) instead, such as Home Network 2.4 GHz and Home Network 5 GHz. See your router documentation or contact your internet service provider for instructions.

Parent topic: [Solving Network Problems](#)

Wired Network Connection Becomes Unstable

When you connect the product to a wired network using a router or access point that supports IEEE 802.3az (Energy Efficient Ethernet), the connection may become unstable, you may be unable to connect to the product, and the communication speed may become slow. If you experience any of these issues, follow the steps below to disable IEEE 802.3az and then connect your product again.

1. Disconnect the Ethernet cables connected to the computer and your product.
2. Disable IEEE 802.3az for the computer's network adapter if it is enabled (check your operating system's Ethernet connection settings).
3. Connect the computer and your product directly with an Ethernet cable.
4. Print a network connection report from your product.
5. On the computer, open a web browser and enter your product's IP address from the network connection report.
6. Select **Network > Wired LAN**.
7. Select **OFF** for IEEE 802.3az. and click **Next**.
8. Click **OK** and remove the Ethernet cable connecting the computer and your product.

9. If you disabled IEEE 802.3az for your computer's network adapter, enable it.
10. Reconnect the Ethernet cables from the router or access point to your computer and product.
If problems still occur, other devices on the network may be causing them.

Parent topic: [Solving Network Problems](#)

Cannot Print Over a Network

If you cannot print over a network, try these solutions:

- Make sure that your product is turned on.
- Make sure you install your product's network software as described in your product documentation.
- Print a network status sheet and verify that the network settings are correct. If the network status is **Disconnected**, check any cable connections and turn your product off and then on again.
- Print a network connection report and check the codes and messages on the report to help determine the cause of the problem.
- If you are using TCP/IP, make sure the product's IP address is set correctly for your network. If your network does not assign IP addresses using DHCP, set the IP address manually.
- If the IP address assigned to the product is 169.254.XX.XX and the subnet mask is 255.255.0.0, the IP address may not be assigned correctly. Check the IP address and subnet mask assigned to the product (**Settings > General Settings > Network Settings > Advanced**) then restart the wireless router or reset the network settings for the product.
- Make sure your computer and product are both using the same wireless network.
- If network printing is slow, print a network status sheet and check the signal strength. If it is poor, place your product closer to your router or access point. Avoid placing your product near a microwave oven, cordless phone, or large metal object, such as a filing cabinet.

Note for Latin America: If you are using a 5 GHz wireless router, set the router to operate in dual band (2.4 GHz and 5 GHz) mode. If your router uses a single network name (SSID) for both the 2.4 GHz and 5 GHz band, give each band its own network name (SSID) instead, such as Home Network 2.4 GHz and Home Network 5 GHz. See your router documentation or contact your internet service provider for instructions.

- Try restarting your router following the instructions in your router documentation.

Note: If you are reading these instructions online, you will lose your Internet connection when you restart your router.

- Check to see if your wireless router or access point has an enabled Privacy Separator function that is preventing printing from a device over the network. See your router or access point documentation for instructions on disabling the Privacy Separator function.
- If you are connecting the product via Wi-Fi Protected Setup (WPS) and the Wi-Fi icon on your product's LCD screen is not lit, make sure you select one of the WPS options from the product control panel within 2 minutes of pressing the WPS button on your router.
- Check your wired LAN router or access point to see if the LED for the port to which your product is connected is on or flashing. If the link LED is off, try the following:
 - Make sure the Ethernet cable is securely connected to your product and to your router, access point, switch, or hub.
 - Try connecting your product to a different port or a different router, access point, switch, or hub.
 - Try connecting with a different Ethernet cable.
 - Try printing to your product from another computer on the network.
- If you are connecting the product via EpsonNet Setup and the Wi-Fi icon does not appear lit on the LCD screen, make sure your product software was installed correctly. If necessary, reinstall your software.

Parent topic: [Solving Network Problems](#)

Related concepts

[Uninstall Your Product Software](#)

Related tasks

[Printing a Network Status Sheet](#)

[Printing a Network Connection Report](#)

Related topics

[Wi-Fi or Wired Networking](#)

Cannot Scan Over a Network

If you cannot scan over a network, try these solutions:

- Make sure the computer and product are connected to the same network (or network segment/VLAN).
- Move the product and computer or smart device closer to the router or access point.
- If network communication was interrupted while starting Epson Scan 2, exit Epson Scan 2, wait a few seconds, and restart it. If Epson Scan 2 cannot restart, turn off your product, turn it back on, and try restarting Epson Scan 2 again.

- If you are scanning a large original at a high resolution, a network communication error may occur. Try scanning again at a lower resolution.
- Check the network connection setting in the Epson Scan 2 Utility.
- Check the scanner setting and reset the connection if necessary using Epson Scan 2 Utility:

Windows 10: Click  and select **EPSON > Epson Scan 2 Utility**. Make sure your product is selected. If necessary, select the **Other** tab and click **Reset**.

Windows 8.x: Navigate to the **Apps** screen, select **EPSON**, and select **Epson Scan 2 Utility**. Make sure your product is selected. If necessary, select the **Other** tab and click **Reset**.

Windows (other versions): Click  or **Start > All Programs** or **Programs > EPSON > Epson Scan 2 > Epson Scan 2 Utility**. Make sure your product is selected. If necessary, select the **Other** tab and click **Reset**.

Mac: Open the **Applications** folder, click **Epson Software**, and click **Epson Scan 2 Utility**. Make sure your product is selected. If necessary, select the **Other** tab and click **Reset**.

- You may need to disable the firewall and any anti-virus software on your wireless router or access point.
- If you see the message "Network product is not available: currently being used by user", there may be a communication error between the product and computer. Restart the product.
- If the Firewall function is active, the product may not be discovered by the Epson Scan 2 Utility. Open the Epson Scan 2 Utility, enter the IP address for your product, and click **Add**.
- If the product and computer cannot communicate and are connected to the same network (or network segment/VLAN), the privacy separator on your router must be disabled. Follow the instructions in your router documentation to disable the privacy separator.

Parent topic: [Solving Network Problems](#)

Related tasks

[Starting a Scan Using the Product Control Panel](#)

[Starting a Scan from a Smartphone or Tablet](#)

[Scanning a Document in Epson ScanSmart](#)

[Starting a Scan Using the Epson Scan 2 Icon](#)

[Starting a Scan from a Scanning Program](#)

Solving Copying Problems

Check these solutions if you have problems copying with your product.

[Product Cannot Copy](#)

[Product Makes Noise, But Nothing Copies](#)

[Product Makes Noise When It Sits for a While](#)

[Originals Do Not Feed From the Automatic Document Feeder](#)

Parent topic: [Solving Problems](#)

Product Cannot Copy

If your product cannot make copies, try these solutions:

- If user restriction has been enabled, you may need to enter a user name and password. Contact your administrator for assistance.
- If the product has an error, such as a paper jam, you cannot make copies. Check the LCD screen for any errors, and follow the onscreen instructions to clear the error.

Parent topic: [Solving Copying Problems](#)

Product Makes Noise, But Nothing Copies

If your product makes a noise, but nothing copies, try these solutions:

- Run a nozzle check to see if any of the print head nozzles are clogged. Then clean the print head, if necessary.
- If the nozzle check page does not print, but the product's power is on, make sure your product software is installed correctly.
- Make sure your product is level (not tilted).

Parent topic: [Solving Copying Problems](#)

Related concepts

[Print Head Nozzle Check](#)

[Print Head Cleaning](#)

Product Makes Noise When It Sits for a While

Your product is performing routine maintenance. This is normal.

Parent topic: [Solving Copying Problems](#)

Originals Do Not Feed From the Automatic Document Feeder

If your originals do not feed when placed in the ADF, try these solutions:

- Make sure the **ADF** icon lights up on the Copy, Fax, or Scan screen on the LCD screen. If not, reload the originals.
- Make sure the size, weight, and number of your originals are supported by the ADF.
- Make sure the originals are loaded correctly.
- Slide the edge guides against the edges of the originals.
- Make sure the document is not curled or creased.
- Try cleaning the inside of the ADF.
- Do not load originals above the arrow mark on the ADF edge guide.

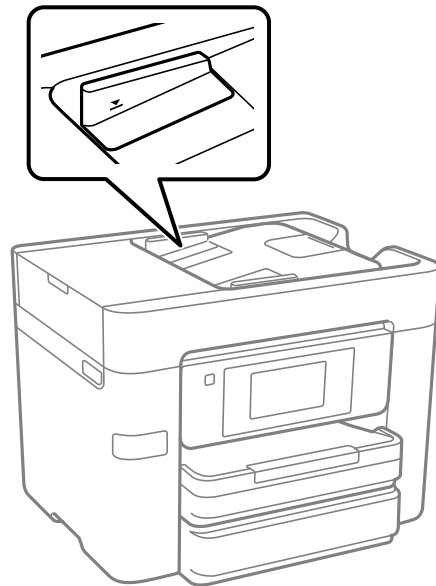

Parent topic: [Solving Copying Problems](#)

Related references

[Document Jams in the Automatic Document Feeder](#)

[ADF Original Document Specifications](#)

Related tasks

[Cleaning Your Product](#)

Solving Paper Problems

Check these sections if you have problems using paper with your product.

[Paper Feeding Problems](#)

[Paper Jam Problems in the Cassette](#)

[Paper Jam Problems in the Rear Cover](#)

[Document Jams in the Automatic Document Feeder](#)

[Paper Ejection Problems](#)

Parent topic: [Solving Problems](#)

Paper Feeding Problems

If you have problems feeding paper, try these solutions:

- Make sure the paper cassette is inserted all the way in the printer.
- Make sure the paper size and type settings match the size and type of paper you loaded.
- If paper does not feed correctly, remove and reload it in the cassette and adjust the edge guides. Make sure the paper stack is not above the tab on the edge guides inside the cassette.
- If multiple pages feed at once, remove the paper, fan the edges to separate the sheets, and reload it.
- Do not load more than the recommended number of sheets.
- Make sure your paper meets the specifications for your product.
- If paper jams when you print on both sides of the paper, try loading fewer sheets.
- If too many pages are fed when you are performing manual 2-sided printing, remove all other paper from the cassette before reloading the paper.
- For best results, follow these guidelines:
 - Use new, smooth, high-quality paper that is not curled, creased, old, too thin, or too thick.
 - Load paper in the cassette printable side down.
 - Follow any special loading instructions that came with the paper.

Note: Your product will not operate properly while tilted at an angle. Place it on a flat, stable surface that extends beyond the base of the product in all directions.

Parent topic: [Solving Paper Problems](#)

Related references

[Paper Jam Problems in the Cassette](#)

[Paper Jam Problems in the Rear Cover](#)

[Document Jams in the Automatic Document Feeder](#)

Paper Jam Problems in the Cassette

If paper has jammed in the cassette, follow the steps here to clear the jam.

Note: Your product may look different than the one shown, but the steps are the same unless otherwise noted.

1. Cancel the print job, if necessary.
2. Pull out the paper cassette.

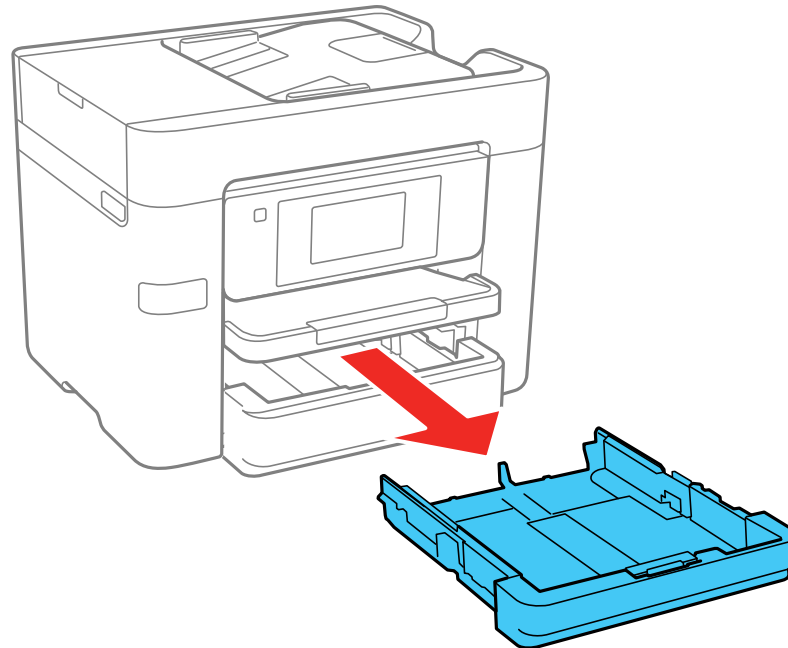

3. Carefully remove any paper jammed inside the product.

4. Carefully follow all paper loading instructions and reload the paper.
5. Keep the cassette flat as you gently insert it.

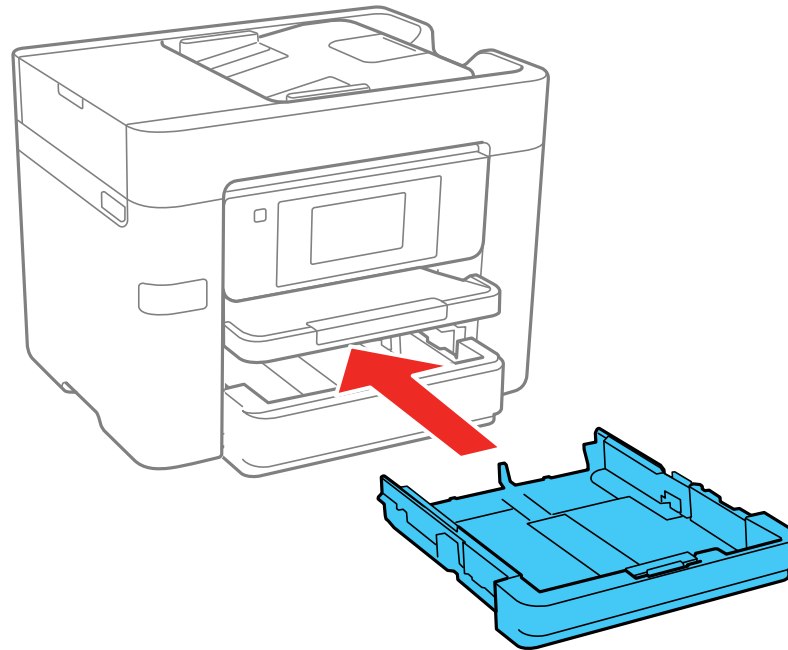

6. Follow the prompts on the LCD screen to clear any error messages. If you still see a paper jam message, check the other paper jam solutions.

Parent topic: [Solving Paper Problems](#)

Related references

[Paper Jam Problems in the Rear Cover](#)

[Document Jams in the Automatic Document Feeder](#)

Related tasks

[Loading Paper in the Cassette](#)

Paper Jam Problems in the Rear Cover

If paper has jammed in the rear cover, follow the steps here to clear the jam.

1. Cancel the print job, if necessary.

2. Squeeze the tabs and open the rear cover.
3. Carefully remove any jammed paper from inside the product.
4. Carefully remove any jammed paper from the duplexer.
5. Close the rear cover.
6. Follow the prompts on the LCD screen to clear any error messages. If you still see a paper jam message, check the other paper jam solutions.

Parent topic: [Solving Paper Problems](#)

Related references

[Paper Jam Problems in the Cassette](#)

[Document Jams in the Automatic Document Feeder](#)

Related tasks

[Loading Paper in the Cassette](#)

Document Jams in the Automatic Document Feeder

If you have problems with document jams in the automatic document feeder (ADF), follow the steps here to clear the jam.

1. Cancel the print job, if necessary.
2. Remove your originals from the ADF.

3. Open the ADF cover.

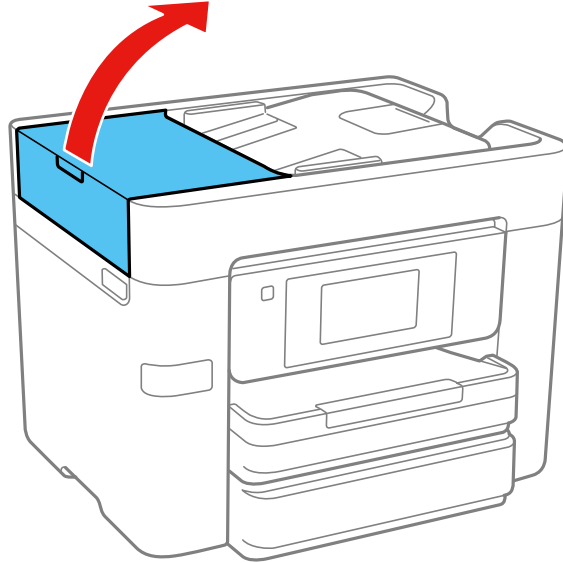

4. Carefully remove any jammed pages.

5. Close the ADF cover, then raise the document cover.

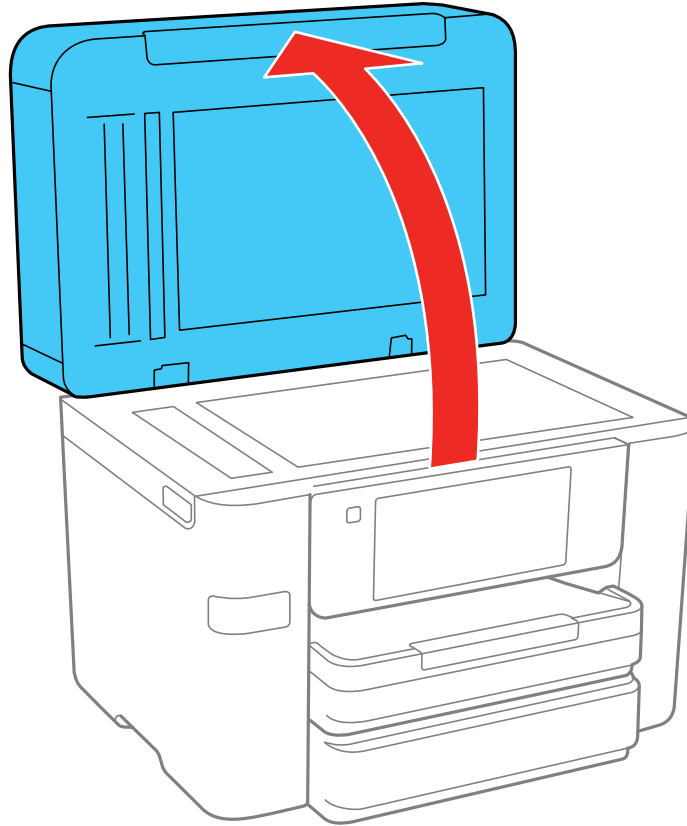

6. Carefully remove any jammed pages.

7. Lower the document cover.

8. Raise the ADF input tray and carefully remove any jammed pages.

9. Lower the ADF input tray.

10. Reload your originals.

Caution: Make sure you do not load the ADF beyond its capacity for your paper size. Also make sure your originals are not bent, folded, or curled and do not have tape, staples, or other materials that could obstruct the feeder.

11. Follow the prompts on the LCD screen to clear any error messages. If you still see a paper jam message, check the other paper jam solutions.

Parent topic: [Solving Paper Problems](#)

Related references

[Paper Jam Problems in the Rear Cover](#)

[Paper Jam Problems in the Cassette](#)

[ADF Original Document Specifications](#)

Related tasks

[Placing Originals in the Automatic Document Feeder](#)

Paper Ejection Problems

If you have problems with paper ejecting properly, try these solutions:

- If paper does not eject fully, you may have set the wrong paper size. Cancel printing to eject the paper. Select the correct paper size when you reprint.
- If paper falls from the output tray, extend the paper stopper.
- If paper is wrinkled when it ejects, it may be damp or too thin. Load new paper.

Parent topic: [Solving Paper Problems](#)

Related references

[Paper or Media Type Settings - Printing Software](#)

Related tasks

[Cancelling Printing Using the Product](#)

[Loading Paper in the Cassette](#)

Solving Problems Printing from a Computer

Check these sections if you have problems while printing from your computer.

Note: When printing using AirPrint, the available print settings are different from those covered in this manual. See the Apple website for details.

[Nothing Prints](#)

[Product Icon Does Not Appear in Windows Taskbar](#)



[Error After Cartridge Replacement](#)

[Printing is Slow](#)

Parent topic: [Solving Problems](#)

Nothing Prints

If you have sent a print job and nothing prints, try these solutions:

- Make sure your product is turned on and connected to your computer.
- Make sure any interface cables are connected securely at both ends.
- Make sure the interface specifications match the specifications for the printer and the computer.
- If you connected your product to a USB hub, make sure it is a first-tier hub. If it still does not print, connect your product directly to your computer instead of the hub.
- If your computer is connected using a USB cable, try a different USB port on your computer or a different cable.
- Make sure the printer status is not offline or pending.
- Run a product check to see if a test page prints. If the test page prints, check to see if your product software is installed correctly.
- Make sure your system meets the requirements for your operating system. If you are printing a high-resolution image, you may need more than the minimum requirements. Print the image at a lower resolution or if necessary, increase your system's memory.
- In Windows, make sure your product is selected as the default printer and the printer port setting matches the printer connection port.
- In Windows, delete all jobs from the Windows Spooler. Click **Print Queue** on the Maintenance tab in the printer settings window, and cancel any stalled print jobs.
- In Windows, do one of the following to open the Epson Printer Connection Checker and follow the on-screen instructions to check the connection status:
 - **Windows 10:** Click  and select **Epson Software > Epson Printer Connection Checker**.
 - **Windows 8.x:** Navigate to the **Apps** screen and select the **Epson Printer Connection Checker** icon.
 - **Windows 7:** Click  and select **All Programs > Epson Software > Epson Printer Connection Checker**.
- On a Mac, make sure the printer is added to the printer list and the printer is not paused.
- Make sure your product is selected as the printer in your printing program.

Parent topic: [Solving Problems Printing from a Computer](#)

Related tasks





[Running a Product Check](#)

[Using AirPrint](#)

Product Icon Does Not Appear in Windows Taskbar

If you do not see your product icon in the Windows taskbar, first try restarting your computer. If that does not work, try this solution:

1. Do one of the following:

- **Windows 11:** Click , search for **Settings** and select it. Select **Devices > Printers & scanners**. Select your product name and select **Printing preferences**.
- **Windows 10:** Click  and select  (Settings) > **Devices > Printers & scanners**. Select your product name and select **Manage > Printing preferences**.
- **Windows 8.x:** Navigate to the **Apps** screen and select **Control Panel > Hardware and Sound > Devices and Printers**. Right-click your product name, select **Printing Preferences**, and select your product name again if necessary.
- **Windows 7:** Click  and select **Devices and Printers**. Right-click your product name, select **Printing Preferences**, and select your product name again if necessary.
- **Windows Vista:** Click , select **Control Panel**, and click **Printer** under **Hardware and Sound**. Right-click your product name, select **Printing Preferences**, and select your product name again if necessary.

2. Click the **Maintenance** tab.

3. Click the **Extended Settings** button.

4. Select **Enable EPSON Status Monitor 3** and click **OK**.

5. Click the **Monitoring Preferences** button.

6. Click the checkbox for the option that adds the shortcut icon to the taskbar.

7. Click **OK** to close the open program windows.

Parent topic: [Solving Problems Printing from a Computer](#)

Error After Cartridge Replacement

If you see an error light or error message after you replace an ink cartridge, follow these steps:

1. Make sure the print head is in the ink cartridge replacement position. (The ink cartridge holder should be beneath the cutout in the product case.)

Note: If the print head is not in the ink cartridge replacement position, follow the instructions on replacing an ink cartridge in this manual to move it.

2. Remove and reinsert the replaced ink cartridge, making sure to push it all the way into its slot.
3. Complete the ink cartridge installation steps.

Parent topic: [Solving Problems Printing from a Computer](#)

Related tasks

[Removing and Installing Ink Cartridges](#)

Printing is Slow

If printing becomes slow, try these solutions:

- Make sure your system meets the requirements for your operating system. If you are printing a high-resolution image, you may need more than the minimum requirements. If necessary, increase your system's memory.
- If you are using Windows 7, close the **Devices and Printers** window before you print.
- On a Mac, make sure you download and install the Epson printer driver.
- Make sure **Quiet Mode** is turned off.
- Clear space on your hard drive or run a defragmentation utility to free up existing space.
- Close any programs you are not using when you print.
- If your product is connected to a USB hub, connect it directly to your computer instead.
- If printing becomes slower after printing continuously for a long time, the product may have automatically slowed down to protect the print mechanism from overheating or becoming damaged. Let the product rest with the power on for 30 minutes, then try printing again.
- If you are printing over a wireless network, factors such as interference, network traffic, or weak signal strength may affect your printing speed.

Note: If you are using a 5 GHz wireless router, set the router to operate in dual band (2.4 GHz and 5 GHz) mode. If your router uses a single network name (SSID) for both the 2.4 GHz and 5 GHz band,

give each band its own network name (SSID) instead, such as Home Network 2.4 GHz and Home Network 5 GHz. See your router documentation or contact your internet service provider for instructions.

For the fastest printing, select the following settings in your product software:

- Make sure the paper type setting matches the type of paper you loaded.
- Turn on any high speed settings in your product software.
- Select a lower print quality setting.
- Make sure the ink drying time has not been increased for double-sided printing.
- **Windows:** Click the **Maintenance** or **Utility** tab, select **Extended Settings** or **Speed and Progress**, and select the following settings:
 - **Always Spool RAW Datatype**
 - **Page Rendering Mode**
 - **Print as Bitmap**
- **Windows:** Select **Printing preferences**, click the **More Options** tab, and make sure the **Bidirectional printing** setting is enabled.
- **Mac:** Select **System Preferences**, select **Printers & Scanners**, and select your product. Select **Options & Supplies**, select **Options** (or **Driver**), and enable the **Bidirectional printing** setting.
- Enable the bidirectional setting on the product control panel (**Settings > General Settings > Printer Settings > Bidirectional**).

If printing is still slow and you are using Windows 7 or Windows Vista, try the following:

1. Click  and select **Computer** or **My Computer**. Double-click the **C:** drive and open these folders: **ProgramData > EPSON > PRINTER**.

Note: If you do not see the ProgramData folder, open the **Organize** menu and select **Folder and search options**. In the window that appears, click the **View** tab, select **Show hidden files, folders, and drives** in the Advanced settings list, and click **OK**.

2. Right-click the **EPAUDF01.AUD** file and select **Delete**.
3. Restart your computer and try printing again.

Parent topic: [Solving Problems Printing from a Computer](#)

Related references

[Paper or Media Type Settings - Printing Software](#)
[Windows System Requirements](#)
[Mac System Requirements](#)

Related tasks

[Selecting Basic Print Settings - Windows](#)
[Selecting Basic Print Settings - Mac](#)
[Selecting Extended Settings - Windows](#)

Solving Page Layout and Content Problems

Check these sections if you have problems with the layout or content of your printed pages.

Note: When printing using AirPrint, the available print settings are different from those covered in this manual. See the Apple website for details.

[Inverted Image](#)
[Too Many Copies Print](#)
[Blank Pages Print](#)
[Incorrect Margins on Printout](#)
[Border Appears on Borderless Prints](#)
[Incorrect Characters Print](#)
[Incorrect Image Size or Position](#)
[Slanted Printout](#)

Parent topic: [Solving Problems](#)

Inverted Image

If your printed image is inverted unexpectedly, try these solutions:

- Turn off any mirror or inversion settings in your printing application.
- Turn off the **Mirror Image**, **Flip horizontally**, or **Reverse page orientation** settings in your printer software. (This option has different names, depending on your operating system version.)

Parent topic: [Solving Page Layout and Content Problems](#)

Related tasks

[Selecting Additional Layout and Print Options - Windows](#)

[Selecting Basic Print Settings - Mac](#)

Too Many Copies Print

Make sure that the **Copies** setting in your printing program or printer software is not set for multiple copies.

Parent topic: [Solving Page Layout and Content Problems](#)

Related tasks

[Selecting Basic Print Settings - Windows](#)

[Selecting Basic Print Settings - Mac](#)

Blank Pages Print

If blank pages print unexpectedly, try these solutions:

- Make sure you selected the correct paper size settings in your printing program and printer software.
- If a blank page exists in a document you are printing and you want to skip printing it, select the **Skip Blank Page** setting in your printer software, if available.
- Run a print head nozzle check to see if any of the nozzles are clogged. Then clean the print head, if necessary.
- Make sure your product is selected as the printer in your printing program.

Parent topic: [Solving Page Layout and Content Problems](#)

Related tasks

[Selecting Basic Print Settings - Windows](#)

[Selecting Extended Settings - Windows](#)

[Selecting Basic Print Settings - Mac](#)

[Selecting Page Setup Settings - Mac](#)

[Cleaning Your Product](#)

Incorrect Margins on Printout

If your printed page has incorrect margins, try these solutions:

- Make sure you selected the correct paper size settings in your printing program and printer software.
- Make sure you selected the correct margins for your paper size in your printing program.
- Make sure your paper is positioned correctly for feeding into the product.

- When placing originals on the scanner glass, align the corner of the original with the corner indicated by the arrow. If the edges of the copy are cropped, move the original slightly away from the corner.
- Clean the scanner glass and the document cover. If there is dust or stains on the glass, the copy area may extend to include the dust or stains.
- Load paper in the correct direction and slide the edge guides against the edges of the paper.
- Select the appropriate original size in the copy settings.

You can use the preview option in your printer software to check your margins before you print.

Parent topic: [Solving Page Layout and Content Problems](#)

Related tasks

[Selecting Basic Print Settings - Windows](#)

[Selecting Basic Print Settings - Mac](#)

Border Appears on Borderless Prints

If you see a border on borderless prints, try these solutions:

- Make sure you are printing on a compatible borderless paper type and size.

Note: For custom paper sizes, make sure you select a supported borderless page width.

- **Windows:** Make sure you selected the **Borderless** setting in your printer software.
- **Mac:** Make sure you selected the **Borderless** checkbox or a paper size with a **Borderless** option in your printer software.
- Adjust the **Expansion** setting to adjust the amount of image expansion on the edges of borderless prints.
- Make sure the image size and the paper size are set correctly; if the image is small, the enlargement may not be enough to cover the paper.
- Access the Extended Settings (Windows) or Printing Preferences (Mac) and select **Remove White Borders**.

Parent topic: [Solving Page Layout and Content Problems](#)

Incorrect Characters Print

If incorrect characters appear in your prints, try these solutions before reprinting:

- Make sure any cables are securely connected at both ends.

- In Windows, delete all jobs from the Windows Spooler. Click **Print Queue** on the Maintenance tab in the printer settings window, and cancel any stalled print jobs.
- If your product is connected to a USB hub, connect it directly to your computer instead.
- If incorrect characters still appear in your prints, try connecting your product using a different cable.
- If your computer entered sleep mode the last time you printed, the next print job after your computer exits sleep mode may contain garbled characters. Print your document again.
- Make sure you are using the printer software for this product. Check the product name at the top of the driver window.

Parent topic: [Solving Page Layout and Content Problems](#)

Related tasks

[Selecting Basic Print Settings - Windows](#)

[Selecting Basic Print Settings - Mac](#)

Incorrect Image Size or Position

If your printed image is the wrong size or in the wrong position, try these solutions:

- Make sure you selected the correct paper size and layout settings in your printing program and printer software.
- Make sure you selected the correct paper size on the control panel.
- Make sure your paper is positioned correctly for feeding into the printer.
- Slide the edge guides against the edges of the paper.
- Clean the scanner glass and document cover.
- If the edges of a copy are cropped, slightly move the original away from the edges of the scanner glass.
- Be sure to select the appropriate original size setting for your original in the copy settings.
- If the image is slightly enlarged and cropped during borderless printing, change the **Expansion** setting.

You can use the preview option in your printer software to check your margins before you print.

Parent topic: [Solving Page Layout and Content Problems](#)

Related tasks

[Selecting Additional Layout and Print Options - Windows](#)

[Selecting Basic Print Settings - Windows](#)

[Selecting Basic Print Settings - Mac](#)
[Selecting Page Setup Settings - Mac](#)
[Cleaning Your Product](#)

Slanted Printout

If your printouts are slanted, try these solutions:

- Make sure your paper meets the specifications for your product.
- Slide the edge guides against the edges of the paper.
- Make sure the paper type setting matches the type of paper you loaded.
- Select a higher print quality setting in your printer software.
- Turn off any high speed settings in your product software.
- Align the print head.
- Adjust the print quality.
- Make sure the product is not printing while tilted or at an angle.

Parent topic: [Solving Page Layout and Content Problems](#)

Related tasks

[Loading Paper in the Cassette](#)

Solving Print Quality Problems

Check these sections if your printouts have problems with print quality, but your image looks fine on your computer screen.

Note: When printing using AirPrint, the available print settings are different from those covered in this manual. See the Apple website for details.

[White or Dark Lines in Printout](#)
[Blurry or Smearred Printout](#)
[Faint Printout or Printout Has Gaps](#)
[Grainy Printout](#)
[Incorrect Colors](#)

Parent topic: [Solving Problems](#)

White or Dark Lines in Printout

If you notice white or dark lines in your prints (also called banding), try these solutions before you reprint:

- Run a nozzle check to see if any of the print head nozzles are clogged. Then clean the print head, if necessary.
- Make sure the paper type setting matches the type of paper you loaded.
- Make sure you loaded the printable side of the paper correctly for your product.
- Turn off any high speed settings in your product software.
- Align the print head. If print quality does not improve after aligning the print head, disable the bidirectional (high speed) setting.
- Adjust the print quality in the product software.
- When horizontal banding appears or the top or bottom of the paper is smeared, load paper in the correct direction and slide the edge guides to the edges of the paper.
- If you are copying from the ADF, copy from the scanner glass instead or use a higher quality setting.
- When vertical banding appears or the paper is smeared, clean the paper path.
- You may need to replace the ink cartridges.

Parent topic: [Solving Print Quality Problems](#)

Related concepts

[Print Head Nozzle Check](#)

[Print Head Cleaning](#)

Related references

[Paper or Media Type Settings - Printing Software](#)

Related tasks

[Aligning the Print Head Using the Product Control Panel](#)

[Selecting Additional Layout and Print Options - Windows](#)

[Selecting Printing Preferences - Mac](#)

[Loading Paper in the Cassette](#)

Related topics

[Replacing Ink Cartridges and Maintenance Boxes](#)

Blurry or Smearred Printout

If your printouts are blurry or smearred, try these solutions:

- Make sure your paper is not damp, curled, old, or loaded incorrectly in your product.
- Slide the edge guides to the edges of the paper.
- Use a support sheet with special paper, or load special paper one sheet at a time.
- Make sure your paper meets the specifications for your product.
- Use Epson papers to ensure proper saturation and absorption of genuine Epson inks.
- Do not load more than the recommended number of sheets. For plain paper, do not load above the line indicated by the triangle symbol on the edge guide.
- Make sure the paper type setting in your product software matches the type of paper you loaded.
- Make sure you loaded the printable side of the paper correctly for your product.
- If you are printing on thick paper or envelopes, turn on the **Thick Paper** setting from the control panel or select **Thick Paper and Envelopes** in the Extended Settings of the printer software. (Turning this setting on will decrease print speed.)
- If paper is still smearred after enabling settings for thick paper, reduce the print density.
- If you are printing on thick paper or envelopes, make sure you select the appropriate settings.
- When manually printing 2-sided, make sure the ink is completely dry before loading the paper.
- Remove each sheet from the output tray as it is printed.
- Do not stack printouts immediately after printing.
- Turn off any high speed settings in your product software.
- When vertical banding appears or the paper is smearred, clean the paper path.
- If you print on both sides of a sheet of paper, smudges may appear on the reverse side of heavily saturated or dark images. If one side of a sheet will contain a lighter image or text, print that side first. Make sure the ink has dried before reloading the paper to print on the other side. Adjust the density and/or ink drying time settings.
- Lower the copy density setting on the product control panel.
- Run a nozzle check to see if any of the print head nozzles are clogged. Then clean the print head, if necessary.
- Align the print head using the **Print Quality Adjustment** setting.
- Clean the paper path.

- Do not press too hard on the original or the document cover when you are scanning originals on the scanner glass.
- Clean the scanner glass.
- Clean the ADF.

Note: Your product will not operate properly while tilted at an angle. Place it on a flat, stable surface that extends beyond the base of the product in all directions.

Parent topic: [Solving Print Quality Problems](#)

Related concepts

[Print Head Cleaning](#)

Related references

[Paper Specifications](#)

[Compatible Epson Papers](#)

Related tasks

[Aligning the Print Head Using the Product Control Panel](#)

[Selecting Double-sided Printing Settings - Windows](#)

[Selecting Basic Print Settings - Windows](#)

[Selecting Additional Layout and Print Options - Windows](#)

Faint Printout or Printout Has Gaps

If your printouts are faint or have gaps, try these solutions:

- Run a nozzle check to see if any of the print head nozzles are clogged. Then clean the print head, if necessary.
- The ink cartridges may be old or low on ink, and you may need to replace them.
- Make sure the paper type setting matches the type of paper you loaded.
- Make sure your paper is not damp, curled, old, or loaded incorrectly in your product.
- When copying, increase the **Density** setting on the product control panel.
- Align the print head.
- Adjust the print quality in the product software.
- Clean the paper path.

Parent topic: [Solving Print Quality Problems](#)

Related concepts

[Print Head Nozzle Check](#)

[Print Head Cleaning](#)

Related references

[Paper or Media Type Settings - Printing Software](#)

Related tasks

[Aligning the Print Head Using the Product Control Panel](#)

[Selecting Basic Print Settings - Windows](#)

[Selecting Basic Print Settings - Mac](#)

[Loading Paper in the Cassette](#)

[Cleaning the Paper Guide](#)

Related topics

[Replacing Ink Cartridges and Maintenance Boxes](#)

Grainy Printout

If your printouts are grainy, try these solutions:

- Make sure you loaded the printable side of the paper correctly for your product.
- Select a higher print quality setting and turn off any high speed settings in your product software.
- Run a nozzle check to see if any of the print head nozzles are clogged. Then clean the print head, if necessary.
- Align the print head using the **Print Quality Adjustment** setting.
- Adjust the print quality in the product software.
- You may need to increase the image resolution or print a smaller size; see your software documentation.

Note: Images from the Internet may be low resolution and not result in a high quality printout.

- If you enlarged the image size in an image-editing program, you need to increase the image resolution setting to retain a high image quality. Increase the image resolution by the same amount you increase the image size. For example, if the image resolution is 300 dpi (dots per inch) and you will double the image size for printing, change the resolution setting to 600 dpi.

Note: Higher resolution settings result in larger file sizes, which take longer to process and print. Consider the limitations of your computer system when selecting a resolution, and select the lowest possible resolution that produces acceptable quality to keep file sizes manageable.

Parent topic: [Solving Print Quality Problems](#)

Related concepts

[Print Head Nozzle Check](#)

[Print Head Cleaning](#)

Related tasks

[Aligning the Print Head Using the Product Control Panel](#)

[Selecting Basic Print Settings - Windows](#)

[Selecting Additional Layout and Print Options - Windows](#)

[Selecting Basic Print Settings - Mac](#)

[Selecting Printing Preferences - Mac](#)

[Loading Paper in the Cassette](#)

Incorrect Colors

If your printouts have incorrect colors, try these solutions:

- Make sure the paper type setting matches the paper you loaded.
- Make sure the **Black/Grayscale** or **Grayscale** setting is not selected in your printer software.
- Select **EPSON Standard** as the **Color Mode** (Windows) or **Mode** (Mac) setting in the printer software.
- Run a nozzle check to see if any of the print head nozzles are clogged. Then clean the print head, if necessary.
- After you print, the colors in your printout need time to set as the ink dries. During this time, the colors may look different than you expect. To speed up drying time, do not stack your printouts on top of each other.
- Your printed colors can never exactly match your on-screen colors. However, you can use a color management system to get as close as possible. Try using the color management options in your printer software.
- Try selecting a different **Color Management** setting on the More Options tab of the printer software, and changing the **Scene Correction** setting to something other than **Auto Correct**.
- For best results, use genuine Epson paper.

- On the product control panel, change the **Enhance** setting from **Auto** to another option, or select **Enhance Off**.

Parent topic: [Solving Print Quality Problems](#)

Related concepts

[Print Head Nozzle Check](#)

[Print Head Cleaning](#)

Related references

[Compatible Epson Papers](#)

Related tasks

[Selecting Basic Print Settings - Mac](#)

[Managing Color - Mac](#)

[Selecting Basic Print Settings - Windows](#)

[Selecting Additional Layout and Print Options - Windows](#)

Related topics

[Replacing Ink Cartridges and Maintenance Boxes](#)

Solving Scanning Problems

Check these solutions if you have problems scanning with your product.

[Scanning Software Does Not Operate Correctly](#)

[Cannot Start Epson Scan 2](#)

[Scanning Speed is Slow](#)

[Cannot Save a Scan to a Shared Folder Over a Network](#)

Parent topic: [Solving Problems](#)

Scanning Software Does Not Operate Correctly

If your scanning software does not operate correctly, try these solutions:

- Make sure your computer has adequate memory and meets the system requirements for your operating system.
- Make sure your computer is not running in a power-saving mode, such as sleep or standby. If so, wake your system and restart your scanning software.
- If you upgraded your operating system but did not reinstall your scanning software, try reinstalling it.

- In Windows, make sure your product is listed as a valid device in the **Scanners and Cameras** control panel.
- If you are scanning with the ADF, make sure the ADF and document covers are closed.
- Try scanning at a lower resolution or increase the free space on the computer's hard disk. Scanning stops if the total data size reaches the limit.

Parent topic: [Solving Scanning Problems](#)

Related concepts

[Uninstall Your Product Software](#)

Cannot Start Epson Scan 2

If you cannot start Epson Scan 2, try these solutions:

- Make sure your product is turned on and any interface cables are securely connected at both ends.
- If your product is connected to a USB hub, connect it directly to your computer instead.
- If you scan at a high resolution over a network, a communication error may occur. Lower the resolution.
- If you are scanning with the ADF, check that the document cover and ADF cover are closed.
- Make sure Epson Scan 2 is selected as your scanning program.
- Make sure your computer is not running in a power-saving mode, such as sleep or standby. If so, wake your system and restart Epson Scan 2.
- Check the connection setting and test the connection using Epson Scan 2 Utility:

Windows 11: Click , search for **Epson Scan 2 Utility** and select it. Make sure the correct product is selected. If necessary, select the **Other** tab and click **Reset**.

Windows 10: Click  and select **EPSON > Epson Scan 2 Utility**. Make sure the correct product is selected. If necessary, select the **Other** tab and click **Reset**.

Windows 8.x: Navigate to the **Apps** screen and select **Epson Scan 2 Utility**. Make sure the correct product is selected. If necessary, select the **Other** tab and click **Reset**.

Windows (other versions): Click  or **Start > All Programs** or **Programs > EPSON > Epson Scan 2 > Epson Scan 2 Utility**. Make sure the correct product is selected. If necessary, select the **Other** tab and click **Reset**.

Mac: Open the **Applications** folder, click **Epson Software**, and click **Epson Scan 2 Utility**. Make sure the correct product is selected. If necessary, select the **Other** tab and click **Reset**.

- Make sure you do not have multiple versions of Epson Scan 2 installed. If you do, uninstall both versions and install one version.
- If you upgraded your operating system but did not reinstall Epson Scan 2, try reinstalling it.

Parent topic: [Solving Scanning Problems](#)

Related concepts

[Uninstall Your Product Software](#)

Scanning Speed is Slow

If scanning speed is slow, try these solutions:

- Lower the scan resolution in the Epson Scan 2 settings. Select a lower resolution, and try scanning again.
- In the Epson Scan 2 window, click the  icon. On the **Scan** tab, make sure **Quiet Mode** is disabled.

Note: **Quiet Mode** is not available on all products.

Parent topic: [Solving Scanning Problems](#)

Cannot Save a Scan to a Shared Folder Over a Network

If you cannot save a scan to a shared folder when scanning over a network, or saving takes a very long time, try these solutions:

- If you cannot scan to a shared folder over the network, make sure you did the following:
 - Created a shared folder on your computer (Windows).
 - If you registered the shared folder path to your product's control panel contact list or entered the path manually to scan, make sure you used the correct path.
 - Make sure the network folder does not already contain a file of the same name. If so, rename the file and try again.
- If you still cannot scan to the shared folder, your network type may be set to **Public**. You cannot scan to a shared folder when using a public network. Follow the steps here to check and change your network type, if necessary. Be sure to log into your Windows computer as an administrator.

Note: The name of available network types varies in the different Windows versions. For details on selecting Windows network sharing settings, see Windows help.

Windows 10:

1. Click  and select **Settings**.
2. Select **Network & Internet**.
3. Click your network type: **Ethernet** or **Wi-Fi**.
4. Click your network name.
5. Make sure the **Make this PC discoverable** setting is set to **On**. Select this setting when connected to a private network so you can save a scan to a shared folder. If you select **Off**, you cannot save your scan to a shared folder on a private network.

Windows 8.1:

1. At the Start screen, type **PC Settings** to automatically search the system.
2. Click **Network** in the PC Settings window.
3. Click your network name.
4. Make sure **Find devices and content** is set to **On**. Select this setting when connected to a private network so you can save a scan to a shared folder. If you select **Off**, you cannot save your scan to a shared folder on a private network.

Windows 8.0:

1. At the Start screen, type **Settings** to automatically search the system.
2. Select **Settings** when it appears and type **Network** into the search field.
3. Right-click your network name in the window that appears and click **Turn sharing on or off**.
4. When you see this message, select **Yes**:

Do you want to turn on sharing between the PCs and connect to devices on this network?

Select this setting when connected to a private network so you can save a scan to a shared folder. If you select **No**, you cannot save your scan to a shared folder on a private network.

Windows 7:

1. Click  or press the Windows key on your keyboard.
2. Type **Network and Sharing Center** into the search field.
3. Under View your active networks, make sure **Home network** or **Work network** is selected when connected to a private network so you can save a scan to a shared folder. (If you need to change the network type, click the network type name.) If you select **Public network**, you cannot save a scan to a shared folder.

- If saving your scan to a shared folder takes a very long time, make sure the DNS setting and the DNS domain name are correct. Contact your network administrator for instructions.

Parent topic: [Solving Scanning Problems](#)

Related topics

[Setting Up and Scanning to a Network Folder or FTP Server](#)

Solving Scanned Image Quality Problems

Check these sections if a scanned image on your computer screen has a quality problem.

Note: For solutions when using the Epson ScanSmart software, see the Epson ScanSmart help utility.

[Scanned Image Quality Problems](#)

[Image Consists of a Few Dots Only](#)

[Line of Dots Appears in All Scanned Images](#)

[Straight Lines in an Image Appear Crooked](#)

[Characters are Not Recognized During Conversion to Editable Text \(OCR\)](#)

[Scanned Characters are Blurry](#)

[Image Colors are Patchy at the Edges](#)

[Ripple Patterns Appear in an Image](#)

[Streaks Appear in All Scanned Images](#)

[Scanned Image Edges are Cropped](#)

Parent topic: [Solving Problems](#)

Scanned Image Quality Problems

If you encounter quality problems with your scanned image, try these solutions:

Image is Distorted or Blurry

- Make sure your original is not wrinkled or warped. This may prevent the original from laying flat on the scanner glass.
- Do not move your original or your product during scanning.
- Clean the scanner glass and the ADF and remove any dirt or dust on your originals.
- Do not press on the document cover or the original with too much force.

- Your product will not operate properly while tilted at an angle. Place your product on a flat, stable surface that extends beyond its base in all directions.
- Adjust these Epson Scan 2 or Epson ScanSmart settings (if available) and try scanning again:
 - Make sure you select the correct **Image Type** for your original.
 - Increase the **Resolution** setting.
 - If the **Image Type** setting is **Black & White**, adjust the **Threshold** setting. (The **Image Option** must be set to **None** or **Color Enhance**.)
 - If the **Image Type** setting is **Color** or **Grayscale**, select the **Unsharp Mask** setting.
 - If the **Image Type** setting is **Black & White**, select **Text Enhancement**. If the **Image Type** setting is **Color** or **Grayscale**, change the **Text Enhancement** setting to **High**.

Image is Too Dark

- Make sure you select the correct **Image Type** for your original.
- If the **Image Type** is set to **Color** or **Grayscale**, adjust the **Brightness** setting.
- Check the brightness and contrast settings of your computer monitor.

Back of Original Image Appears in Scanned Image

- Place a piece of black paper on the back of the original and scan it again.
- Adjust these Epson Scan 2 or Epson ScanSmart settings (if available) and try scanning again:
 - Make sure you select the correct **Image Type** for your original.
 - Select the **Advanced Settings** tab and adjust the **Brightness** setting.
 - If the **Image Type** is set to **Black & White**, select **Text Enhancement**. If the **Image Type** is set to **Color** or **Grayscale**, change the **Text Enhancement** setting to **High**.

Scanned Image Colors Do Not Match Original Colors

Printed colors can never exactly match the colors on your computer monitor because printers and monitors use different color systems: monitors use RGB (red, green, and blue) and printers typically use CMYK (cyan, magenta, yellow, and black).

Check the color matching and color management capabilities of your computer, display adapter, and the software you are using to see if they are affecting the palette of colors you see on your screen.

To adjust the colors in your scanned image, adjust these Epson Scan 2 or Epson ScanSmart settings (if available) and try scanning again:

- Make sure you select the correct **Image Type** for your original.

- If the **Image Type** setting is **Color** or **Grayscale**, adjust the **Contrast** setting.
- If the **Image Type** setting is **Black & White** or **Grayscale**, adjust the **Color Enhance** setting.

Parent topic: [Solving Scanned Image Quality Problems](#)

Image Consists of a Few Dots Only

If your scanned image consists only of a few dots, try these solutions:

- Make sure you placed your original for scanning facing the correct way.
- Make sure you select the correct **Image Type** for your original.
- If the **Image Type** setting is **Black & White**, adjust the **Threshold** and scan again.
- Remove any lint or dirt from your original.
- Clean the scanner glass.
- Do not press on the original or the document cover with too much force.

Parent topic: [Solving Scanned Image Quality Problems](#)

Related references

[Additional Scanning Settings - Advanced Settings Tab](#)

Line of Dots Appears in All Scanned Images

If a line of dots appears in all your scanned images, try these solutions:

- Clean the scanner glass with a soft, dry, lint-free cloth or use a small amount of glass cleaner on the cloth, if necessary. Paper towels are not recommended.

Caution: Do not spray glass cleaner directly on the scanner glass.

- Make sure any interface cables are securely connected at both ends.
- Keep the document cover closed to prevent dirt or dust from getting inside.

If you are scanning from the ADF, make sure the ADF edge guides fit against the loaded originals. You can also try cleaning the ADF and scanning again.

Parent topic: [Solving Scanned Image Quality Problems](#)

Related tasks

[Cleaning Your Product](#)

Straight Lines in an Image Appear Crooked

If straight lines in an original appear crooked in a scanned image, make sure to place your original straight when you scan it.

If you are scanning from the ADF, make sure the ADF edge guides fit against the loaded originals. You can also try cleaning the ADF and scanning again.

Parent topic: [Solving Scanned Image Quality Problems](#)

Related topics

[Placing Originals on the Product](#)

Characters are Not Recognized During Conversion to Editable Text (OCR)

If characters in your scanned images are not recognized during OCR conversion, try these solutions:

- Make sure your original is loaded straight on your product.
- Use an original with clear text.
- When saving scanned images as Searchable PDFs, make sure the correct OCR language is selected.
- Adjust the following Epson Scan 2 or Epson ScanSmart settings if available, and try scanning again:
 - On the **Main Settings** tab, make sure you select the correct **Image Type** for your original.
 - On the **Main Settings** tab, set the **Resolution** between 200 and 600 dpi.
 - On the **Advanced Settings** tab, select **Text Enhancement** and choose a setting.

Note: The **Text Enhancement** setting depends on the selected **Image Type**.

- If the **Image Type** is set to **Black & White**, adjust the **Threshold** setting on the **Advanced Settings** tab. (The **Image Option** must be set to **None**.)

Parent topic: [Solving Scanned Image Quality Problems](#)

Scanned Characters are Blurry

If characters in your scanned images are blurry, try these solutions:

- Make sure you do not move the product or original while scanning.
- Operate the product on a flat, stable surface.
- Make sure the originals are ejecting properly.

- Select **Settings > Scan Settings** and try adjusting these settings and scanning again:
 - On the **Main Settings** tab, make sure you select the correct **Image Type** for your original.
 - On the **Main Settings** tab, try increasing the **Resolution** setting.
 - On the **Advanced Settings** tab, select **Text Enhancement** and choose a setting.

Note: The **Text Enhancement** setting depends on the selected **Image Type**.

- If the **Image Type** is set to **Black & White**, adjust the **Threshold** setting on the **Advanced Settings** tab. (The **Image Option** must be set to **None**.)

Parent topic: [Solving Scanned Image Quality Problems](#)

Image Colors are Patchy at the Edges

If you are scanning a thick or warped original, cover its edges with paper to block external light as you scan it.

Parent topic: [Solving Scanned Image Quality Problems](#)

Ripple Patterns Appear in an Image

You may see a ripple pattern (called a moiré) in scanned images of printed documents. This is caused by interference from differing pitches in the scanner's screen and your original's halftone screen. To reduce this effect, adjust these Epson Scan settings (if available) and try scanning again:

- Select the **Descreening** setting on the Advanced Settings tab.
- Select a lower **Resolution** setting.
- Place the original at a slightly different angle.

Parent topic: [Solving Scanned Image Quality Problems](#)

Related references

[Additional Scanning Settings - Main Settings Tab](#)

[Additional Scanning Settings - Advanced Settings Tab](#)

Streaks Appear in All Scanned Images

If streaks appear in all your scanned images, try these solutions:

- Clean the scanner glass with a soft, dry, lint-free cloth or use a small amount of glass cleaner on the cloth, if necessary. Paper towels are not recommended.

- Keep the document cover closed to prevent dirt or dust from getting inside.

Parent topic: [Solving Scanned Image Quality Problems](#)

Scanned Image Edges are Cropped

If the edges of a scanned image are cropped, make sure your original is placed correctly for scanning. If necessary, move your original away from the edges of the scanner glass slightly.

In the Epson Scan 2 or Epson ScanSmart settings, set the **Edge Fill** setting to **None**.

Parent topic: [Solving Scanned Image Quality Problems](#)

Related topics

[Placing Originals on the Product](#)

Solving Faxing Problems

Check these solutions if you have problems faxing with your product.

[Cannot Send or Receive Faxes](#)

[Cannot Receive Faxes with a Telephone Connected to Your Product](#)

[Fax Memory Full Error Appears](#)

[Fax Quality is Poor](#)

[Sent Fax is Received in an Incorrect Size](#)

[Received Fax is Not Printed](#)

Parent topic: [Solving Problems](#)

Cannot Send or Receive Faxes

If you cannot send or receive faxes, try these solutions:

- Use **Check Fax Connection** on the control panel (**Settings > General Settings > Fax Settings > Check Fax Connection**) to run the automatic fax connection check. Try the solutions suggested in the report.
- If you are faxing from a computer, use the Epson FAX Utility to send your fax.
- Make sure the recipient's fax machine is turned on and working.
- Make sure the recipient's fax number is correct and entered correctly.
- Make sure paper is loaded correctly in your product.
- Make sure you have set up your header information and have not blocked your caller ID. Otherwise, your faxes might be rejected by the recipient's fax machine.

- Make sure Receive Mode is set to **Auto** so you can receive faxes automatically.
- Check that the cable connecting your telephone wall jack to your product's **LINE** port is secure.
- Print a fax connection report using your product control panel or fax software to help diagnose the problem.
- Verify that the telephone wall jack works by connecting a phone to it and testing it.
- Check the **Line Type** setting and set it to **PBX**. If your phone system requires an external access code to reach an outside line, register the code to the product and add a # (hash) to the beginning of the phone number when dialing.
- If you connected your product to a DSL phone line, you must connect a DSL filter to the phone jack to enable faxing over the line. Contact your DSL provider for the necessary filter.
- If you are connected to a DSL phone line, connect the product directly to a telephone wall jack and send a fax. If it works, the problem may be caused by the DSL filter. Contact your DSL provider.
- Make sure you installed the FAX driver for your product and that it is not paused.
- The data being sent may be too large. Try faxing the originals in batches or by using a connected phone. If you are faxing in monochrome, enable the **Direct Send** setting (**Fax > Fax Settings > Fax Send Settings**).
- If a communication error occurs, change the **Fax Speed** setting to **Slow(9,600bps)** on the control panel.
- If your telephone line uses call waiting and you have trouble receiving faxes, turn off call waiting to prevent disruption of incoming faxes.
- If you have subscribed to a call forwarding service, the product may not be able to receive faxes. Contact your service provider for assistance.
- If the recipient fax machine does not answer your call within 50 seconds after the product has finished dialing, add pauses after the fax number to send the fax.
- Check your inbox and delete faxes after reading or printing them. If the inbox is full, the product cannot receive faxes.
- Check if the sender's fax number is registered to the **Rejection Number List**
- If you enabled **Rejection Fax** options, check if the sender is blocked, did not set up header information, or is not registered in your contacts list, as necessary.
- If you have not connected a telephone to the printer, set the **Receive Mode** setting to **Auto** on the control panel.
- If you are receiving faxes using the Epson FAX Utility, check that your product is registered as a fax product in your operating system:

Windows: Make sure the product appears in **Devices and Printers**, **Printer**, or **Printers and Other Hardware**. If the product does not appear, uninstall and re-install the Epson FAX Utility.

Mac: Select **System Preferences > Printers & Scanners** (or **Print & Scan** or **Print & Fax**) and make sure your product appears. If your product does not appear, click **+** and add your product. If the product does appear, double-click it and make sure it is not paused.

Note: Do not turn the product off while it is receiving a fax. Otherwise, the fax transmission will be lost.

Note: If your product is connected to a VoIP (Voice over Internet Protocol) phone line, keep in mind that fax machines are designed to work over analog phone lines. Epson cannot guarantee that fax transmission will work when using VoIP.

If your phone line includes voice mail answering services, calls or faxes may be inadvertently received by your voice mail service.

Parent topic: [Solving Faxing Problems](#)

Related tasks

[Connecting a Telephone or Answering Machine](#)

[Using the Fax Setup Wizard](#)

[Selecting the Line Type](#)

[Selecting Advanced Fax Settings](#)

[Receiving Faxes Automatically](#)

[Printing Fax Reports](#)

[Viewing a Fax on the LCD Screen \(Using the Inbox\)](#)

[Loading Paper in the Cassette](#)

Cannot Receive Faxes with a Telephone Connected to Your Product

If you cannot receive faxes when a telephone is connected to your product, try these solutions:

- Make sure your telephone is connected to your product's **EXT** port.
- Make sure the Receive Mode is set to **Manual**.

Note: When answering a call that is a fax, wait until the product's LCD screen displays a message that a connection has been made before you hang up.

Parent topic: [Solving Faxing Problems](#)

Related tasks

[Connecting a Telephone or Answering Machine](#)
[Using the Fax Setup Wizard](#)

Fax Memory Full Error Appears

If you see an error message telling you that the product's fax memory is full, try these solutions:

- If you set the product to save received faxes in the product's memory or inbox, delete any faxes you have already read.

Note: Your product can store up to 100 faxes before its inbox is full.

- If you set the product to save received faxes on a computer, turn on the selected computer. Once the faxes are saved on the computer, they are deleted from the product's memory.
- If you set the product to save received faxes on a USB device, connect the selected USB device containing the save fax folder to the product. Once the faxes are saved on the USB device, they are deleted from the product's memory.

Note: Make sure the USB device has enough available memory and is not write protected.

- If the memory is full, try the following:
 - Send a monochrome fax using the direct sending feature
 - Send your faxes in smaller batches
- If the product cannot print a received fax due to a product error, such as a paper jam, the memory full error may appear. Clear any product errors, then ask the sender to resend the fax.

Parent topic: [Solving Faxing Problems](#)

Related references

[Fax Sending Options](#)

Related tasks

[Viewing a Fax on the LCD Screen \(Using the Inbox\)](#)
[Saving Faxes to an External USB Device](#)

Fax Quality is Poor

If you receive a poor quality fax, try these solutions:

- Try enabling the error correction mode (ECM) setting.

- Contact the fax sender and ask them to send the fax in a higher resolution.
- Try reprinting the received fax.

If the sent fax quality is poor, try these solutions:

- Clean the scanner glass.
- Clean the ADF.
- Try changing the resolution or density setting on the control panel.
- Do not press on the document cover or the original with too much force.
- Try changing the original type setting on the control panel.
- If you are sending a monochrome fax to a single recipient, try sending the fax using the **Direct Send** feature.

Note: If you send a high-resolution monochrome fax without using the **Direct Send** feature, the product may automatically lower the resolution.

- Try enabling the error correction mode (ECM) setting.
- If the back of the original appears in your sent fax, place a piece of black paper on the back of the original and fax it again.

Parent topic: [Solving Faxing Problems](#)

Sent Fax is Received in an Incorrect Size

If your recipient receives a fax in an incorrect size, try these solutions:

- If you notice size problems in a copied, scanned, or faxed image, turn off the **Original Size Auto Detection (Glass)** setting in the **Settings > General Settings > Basic Settings** menu. Make sure the product is out of direct sunlight.
- If you are sending a fax using the scanner glass, make sure your original is placed correctly and that the correct paper size is selected on the control panel.
- Clean the scanner glass and document cover.

Parent topic: [Solving Faxing Problems](#)

Related tasks

[Cleaning Your Product](#)

Related topics

[Placing Originals on the Product](#)

Received Fax is Not Printed

If a received fax is not printed, try these solutions:

- Make sure the product is free of errors. The product cannot print received faxes if an error has occurred with the product, such as a paper jam.
- If the product has been set to save received faxes in the product's memory or inbox, received faxes are not automatically printed. Check the **Receive Settings** options on the product control panel and change them, if necessary.

Parent topic: [Solving Faxing Problems](#)

Related tasks

[Viewing a Fax on the LCD Screen \(Using the Inbox\)](#)

[Saving Faxes to an External USB Device](#)

Solving USB Device Problems

Check these solutions if you have problems using USB devices with your product.

[Cannot View or Print from a USB Device](#)

[Cannot Save Files on a USB Device](#)

[Cannot Transfer Files To or From a USB Device](#)

Parent topic: [Solving Problems](#)

Cannot View or Print from a USB Device

If you cannot view or print photos or documents from a USB device connected to your product, try these solutions:

- Make sure memory devices are enabled on the product.
- Make sure your device is compatible with the product.
- Make sure the files on your device are in the correct format.
- If you see an X on the photo selection screen, the image file format is not supported.

Parent topic: [Solving USB Device Problems](#)

Related references

[External USB Device Specifications](#)

[USB Device Photo File Specifications](#)

Related tasks

[Setting Up File Sharing for File Transfers from Your Computer](#)

Related topics

[Viewing and Printing from the LCD Screen](#)

Cannot Save Files on a USB Device

If you cannot save files on a USB device connected to your product, try these solutions:

- To save faxes on a USB device, create a folder in the **Fax Output** settings on the product control panel.
- Make sure the device is not write-protected.
- Make sure the device has enough available space.
- Make sure memory devices are enabled on your product.
- Make sure the device is compatible with the product.

Parent topic: [Solving USB Device Problems](#)

Related references

[External USB Device Specifications](#)

Related tasks

[Saving Faxes to an External USB Device](#)

[Setting Up File Sharing for File Transfers from Your Computer](#)

Cannot Transfer Files To or From a USB Device

If you have problems transferring files to or from a USB device connected to your product, try these solutions:

- Make sure your device is compatible with the product.
- Make sure the device is not write-protected.
- Make sure there is enough free space on the device.
- Make sure your product is securely connected to your computer.
- Make sure that the file sharing setting for your product is enabled.

Parent topic: [Solving USB Device Problems](#)

Related references

[External USB Device Specifications](#)

Related tasks

[Transferring Files from a USB Device to Your Computer](#)

Uninstall Your Product Software

If you have a problem that requires you to uninstall and re-install your software, follow the instructions for your operating system.



[Uninstalling Product Software - Windows](#)

[Uninstalling Product Software - Mac](#)

Parent topic: [Solving Problems](#)

Uninstalling Product Software - Windows

You can uninstall and then re-install your product software to solve certain problems.

1. Turn off the product.
2. Close any open programs or applications.
3. Disconnect any interface cables.
4. Do one of the following:
 - **Windows 11:** Click , then search for **Settings** and select it. Select **Apps** or **System > Apps & features**. Then select the program you want to uninstall and select **Uninstall**.
 - **Windows 10:** Click  and select  (Settings) > **Apps** or **System > Apps & features**. Then select the program you want to uninstall and select **Uninstall**.
 - **Windows 8.x:** Navigate to the **Apps** screen and select **Control Panel > Programs > Programs and Features**. Select the uninstall option for your Epson product, then select **Uninstall/Change**.

Note: If you see a **User Account Control** window, click **Yes** or **Continue**.

Select your product again, if necessary, then select **OK**, and click **Yes** to confirm the uninstallation.

- **Windows (other versions):** Click  or **Start**, and select **All Programs** or **Programs**. Select **EPSON**, select your product, then click **EPSON Printer Software Uninstall**.

Note: If you see a **User Account Control** window, click **Yes** or **Continue**.

In the next window, select your product and click **OK**. Then follow any on-screen instructions.

5. Do one of the following to uninstall Epson Event Manager, then follow any on-screen instructions:
 - **Windows 11/Windows 10/8.x:** Select **Epson Event Manager** and click **Uninstall**.
 - **Windows 7/Windows Vista:** Open the Windows **Control Panel** utility. Select **Programs and Features**. (In Classic view, select **Programs** and click **Uninstall a program**.) Select **Epson Event Manager** and click **Uninstall/Change**.
6. Do one of the following to uninstall Epson Scan 2, then follow any on-screen instructions:
 - **Windows 11/Windows 10:** Select **Epson Scan** and click **Uninstall**.
 - **Windows 8.x/Windows 7/Windows Vista:** Select **Epson Scan 2** and click **Uninstall/Change**.
7. Do one of the following to uninstall Epson ScanSmart, then follow any on-screen instructions:
 - **Windows 11/Windows 10:** Select **Epson ScanSmart** and click **Uninstall**.
 - **Windows 8.x/Windows 7/Windows Vista:** Select **Epson ScanSmart** and click **Uninstall/Change**.
8. Restart your computer, then see the *Start Here* sheet to re-install your software.

Note: If you find that re-installing your product software does not solve a problem, contact Epson.

Parent topic: [Uninstall Your Product Software](#)

Uninstalling Product Software - Mac

In most cases, you do not need to uninstall your product software before re-installing it. However, you can download the Uninstaller utility from the Epson support website to uninstall your product software as described here.

Note: If you find that re-installing your product software does not solve a problem, contact Epson.

1. To download the Uninstaller utility, visit epson.com/support (U.S.) or epson.ca/support (Canada) and select your product.
2. Click **Downloads**.
3. Select your operating system, click **Utilities**, locate the Uninstaller utility, and click **Download**.
4. Run the file you downloaded.
5. Double-click the **Uninstaller** icon.

6. In the Epson Uninstaller screen, select the checkbox for each software program you want to uninstall.
7. Click **Uninstall**.
8. Follow the on-screen instructions to uninstall the software.
9. Reinstall your product software.

Note: If you uninstall the printer driver and your product name remains in the **Print & Fax, Print & Scan,** or **Printers & Scanners** window, select your product name and click the – (remove) icon to remove it.

Parent topic: [Uninstall Your Product Software](#)

Where to Get Help

If you need to contact Epson for technical support services, use the following support options.

Internet Support

Visit Epson's support website at epson.com/support (U.S.) or epson.ca/support (Canada) and select your product for solutions to common problems. You can download drivers and documentation, get FAQs and troubleshooting advice, or e-mail Epson with your questions.

Speak to a Support Representative

Before you call Epson for support, please have the following information ready:

- Product name
- Product serial number (located on a label on the product)
- Proof of purchase (such as a store receipt) and date of purchase
- Computer configuration
- Description of the problem

Then call:

- U.S.: (562) 276-4382, 7 AM to 4 PM, Pacific Time, Monday through Friday
- Canada: (905) 709-3839, 7 AM to 4 PM, Pacific Time, Monday through Friday

Days and hours of support are subject to change without notice. Toll or long distance charges may apply.

Purchase Supplies and Accessories

You can purchase genuine Epson ink and paper at epson.com (U.S. sales) or epson.ca (Canadian sales). You can also purchase supplies from an Epson authorized reseller. To find the nearest one, call 800-GO-EPSON (800-463-7766) in the U.S. or 800-807-7766 in Canada.

Parent topic: [Solving Problems](#)

Technical Specifications

These sections list the technical specifications for your product.

Note: Epson offers a recycling program for end of life Epson products. Please go to [this site](#) (U.S) or [this site](#) (Canada) for information on how to return your Epson products for proper disposal.

[Windows System Requirements](#)

[Mac System Requirements](#)

[Paper Specifications](#)

[Printable Area Specifications](#)

[Automatic Document Feeder \(ADF\) Specifications](#)

[Scanning Specifications](#)

[Fax Specifications](#)

[Ink Cartridge Specifications](#)

[Dimension Specifications](#)

[Electrical Specifications](#)

[Environmental Specifications](#)

[External USB Device Specifications](#)

[Interface Specifications](#)

[Network Interface Specifications](#)

[Safety and Approvals Specifications](#)

Windows System Requirements

To use your product and its software, your computer should use one of these Microsoft operating systems:

- Windows 10
- Windows 8.x
- Windows 7
- Windows Vista
- Windows Server 2003 SP2 or later

Note: For the latest product software available for your operating system, visit the Epson support site at epson.com/support (U.S.) or epson.ca/support (Canada), select your product, and select **Downloads**.

Parent topic: [Technical Specifications](#)

Mac System Requirements

To use your product and its software, your Mac should use one of these operating systems:

- macOS 12.x
- macOS 11.x
- macOS 10.15.x
- macOS 10.14.x
- macOS 10.13.x
- macOS 10.12.x
- OS X 10.11.x
- OS X 10.10.x
- OS X 10.9.x
- OS X 10.8.x
- OS X 10.7.x

Note: For the latest product software available for your operating system, visit the Epson support site at epson.com/support (U.S.) or epson.ca/support (Canada), select your product, and select **Downloads**.

Parent topic: [Technical Specifications](#)

Paper Specifications

Note: Since the quality of any particular brand or type of paper may be changed by the manufacturer at any time, Epson cannot guarantee the quality of any non-Epson brand or type of paper. Always test a sample of paper stock before purchasing large quantities or printing large jobs.

Single-sheets

Size

A4 (8.3 × 11.7 inches [210 × 297 mm])
A5 (5.8 × 8.2 inches [148 × 210 mm])
A6 (4.1 × 5.8 inches [105 × 148 mm])
16:9 wide (4 × 7.1 inches [102 × 181 mm])
Letter (8.5 × 11 inches [216 × 279 mm])
Legal (8.5 × 14 inches [216 × 356 mm])
8 × 10 inches (203 × 254 mm)
8.5 × 13 inches (216 × 330 mm)
Executive (7.25 × 10.5 inches [184 × 267 mm])
Mexico-Oficio (8.5 × 13.4 inches [216 × 340 mm])
Oficio 9 (8.46 × 12.4 inches [215 × 315 mm])
Half Letter (5.5 × 8.5 inches [140 × 216 mm])

Paper types

Plain paper and thick paper

Note: Your product also supports compatible papers distributed by Epson. See the link at the end of this topic for a list of compatible Epson papers.

Weight

Plain paper: 17 lb (64 g/m²) to 24 lb (90 g/m²)
Thick paper: 25 lb (91 g/m²) to 68 lb (256 g/m²)

Envelopes

Size

No. 10 (4.1 × 9.5 inches [105 × 241 mm])

Paper types

Plain bond paper

Weight

20 lb (75 g/m²) to 27 lb (100 g/m²)

Parent topic: [Technical Specifications](#)

Printable Area Specifications

Note: When printing borderless, quality may decline in the expanded printable area.

Single sheets - borders

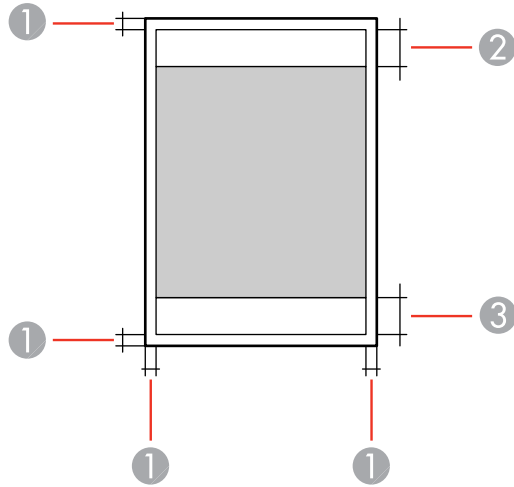

- 1 Top/bottom/left/right margins: 0.12 inch (3 mm) minimum
- 2 Reduced print quality area/top: 1.85 inches (47 mm) minimum
- 3 Reduced print quality area/bottom: 1.77 inches (45 mm) minimum

Single sheets - borderless

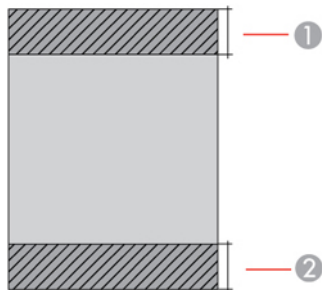

- 1 Reduced print quality area/top: 1.97 inches (50 mm) minimum
- 2 Reduced print quality area/bottom: 1.89 inches (48 mm) minimum

Envelopes

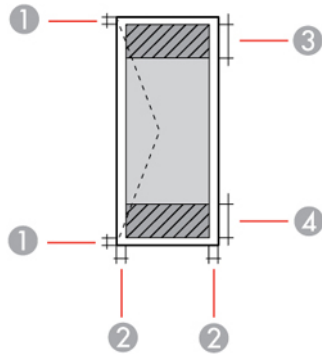

- 1 Right/left margins: 0.12 inch (3 mm) minimum
- 2 Top/bottom margins: 0.12 inch (3 mm) minimum
- 3 Reduced print quality area/right: 0.71 inch (18 mm) minimum
- 4 Reduced print quality area/left: 1.85 inches (47 mm) minimum

Parent topic: [Technical Specifications](#)

Automatic Document Feeder (ADF) Specifications

Paper input	Faceup loading
Paper output	Facedown ejection
Paper size	US letter, A5, 8.5 × 13, legal, or A4 size
Paper type	Plain paper
Paper weight	17 lb (64 g/m ²) to 24 lb (90 g/m ²)
Sheet feeding capacity	Approximately 50 sheets (US letter, A4, or A5) or 10 sheets (legal or 8.5 × 13)

Parent topic: [Technical Specifications](#)

Scanning Specifications

Scanner type	Flatbed, color
Photoelectric device	CIS
Effective pixels	10200 × 14040 pixels at 1200 dpi
Document size	Maximum: 8.5 × 11.7 inches (216 × 297 mm) Scanner glass: US letter or A4
Scanning resolution	1200 dpi (main scan) 2400 dpi (sub scan)
Output resolution	(50 to 9600 dpi in 1 dpi increments)
Image data	Color: 48 bits per pixel internal (16 bits per pixel per color internal) 24 bits per pixel external (8 bits per pixel per color internal) Grayscale: 16 bits per pixel internal 8 bits per pixel external Black and white: 16 bits per pixel internal 1 bit per pixel external
Light source	LED

Parent topic: [Technical Specifications](#)

Fax Specifications

Fax type	Black-and-white and color fax capability
Support line	Standard analogue telephone lines, PBX (Private Branch Exchange) telephone systems
Speed	Up to 33.6 kbps

Resolution	<p>Monochrome</p> <p>Standard: 203 pixels per inch × 98 lines per inch (8 pixels per mm × 3.85 lines per mm)</p> <p>Fine: 203 pixels per inch × 196 lines per inch (8 pixels per mm × 7.7 lines per mm)</p> <p>Super Fine: 203 pixels per inch × 392 lines per inch (8 pixels per mm × 15.4 lines per mm)</p> <p>Ultra Fine: 406 pixels per inch × 392 lines per inch (16 pixels per mm × 15.4 lines per mm)</p> <p>Photo: 203 pixels per inch × 196 lines per inch (8 pixels per mm × 7.7 lines per mm)</p> <p>Color</p> <p>Fine: 200 × 200 dpi</p> <p>Photo: 200 × 200 dpi</p>
Error correction mode	ITU-T Super Group 3
Speed dial/group dial numbers	Up to 100 (speed dial) or 99 (group dial)
Page memory	Up to 180 (ITU-T No. 1 chart)
Redial	2 times (with 1 minute interval)
Interface	RJ-11 Phone Line RJ-11 Telephone set connection

Parent topic: [Technical Specifications](#)

Ink Cartridge Specifications

Note: Your printer is designed to work only with genuine Epson-brand ink cartridges. Other brands of ink cartridges and ink supplies are not compatible and, even if described as compatible, may not function properly or at all. Epson periodically provides firmware updates to address issues of security, performance, minor bug fixes and ensure the printer functions as designed. These updates may affect the functionality of third-party ink. Non-Epson branded or altered Epson cartridges that functioned prior to a firmware update may not continue to function.

The included initial cartridges are designed for reliable printer setup and cannot be used as replacement cartridges or resold. After setup, the remaining ink is available for printing. Yields are based on ISO

24711 in default mode, printing continuously. Yields vary due to print images, settings, and temperatures. Printing infrequently or primarily with one color reduces yields. All cartridges must be installed with ink for printing and printer maintenance. For print quality, some ink remains in replaced cartridges.

Color	Cyan, Magenta, Yellow, Black
Cartridge life	Opened package: 6 months Unopened package: do not use if the date on the package has expired
Temperature	Storage: -22 to 104 °F (-30 to 40 °C) 1 month at 104 °F (40 °C) Ink freezes at 3.2 °F (-16 °C) Ink thaws and is usable after 3 hours at 77 °F (25 °C)

Note: For best printing results, use up a cartridge within 6 months of opening the package.

Parent topic: [Technical Specifications](#)

Dimension Specifications

Height	Stored: 13 inches (330 mm) Printing: 13 inches (330 mm)
Width	Stored: 16.7 inches (425 mm) Printing: 16.7 inches (425 mm)
Depth	Stored: 15.3 inches (388 mm) Printing: 19.8 inches (503 mm)
Weight (without ink cartridges or power cord)	26.2 lb (11.9 kg)

Parent topic: [Technical Specifications](#)

Electrical Specifications

Power supply rating	100 to 240 V
Input voltage range	90 to 264 V
Rated frequency range	50/60 Hz
Input frequency range	49.5/60.5 Hz
Rated current	0.5 to 0.3 A
Power consumption	Standalone copying: 17 W (ISO/IEC24712) Ready mode: 6.2 W Sleep mode: 1.2 W Power off mode: 0.2 W

Parent topic: [Technical Specifications](#)

Environmental Specifications

Temperature	Operating: 50 to 95 °F (10 to 35 °C) Storage (after initial ink charge): 5 to 104 °F (-15 to 40 °C) Storage (before initial ink charge): -4 to 104 °F (-20 to 40 °C) 1 month at 104 °F (40 °C)
Humidity (without condensation)	Operating: 20 to 80% RH Storage: 5 to 85% RH

Parent topic: [Technical Specifications](#)

External USB Device Specifications

Do not use devices with the following requirements:

- Dedicated driver
- Security settings (such as passwords, encryption, etc.)
- Built-in USB hub

Note: Use only external storage devices with independent AC power sources. External storage devices that are powered via USB are not recommended. Epson cannot guarantee the operation of externally connected devices.

Hard disk drives and USB flash drives	2TB Formatted in FAT, FAT32, or exFAT.
Multi-card reader	2TB Formatted in FAT, FAT32, or exFAT.

Note: Only insert one memory card into the multi-card reader. Multi-card readers with more than one card inserted are not supported.

Parent topic: [Technical Specifications](#)

Interface Specifications

Interface type	Hi-Speed USB (Device Class for computers)* Hi-Speed USB (for Mass storage class for external storage)
-----------------------	--

*: USB 3.0 cables are not supported.

Note: Epson cannot guarantee the operation of externally connected devices.

Parent topic: [Technical Specifications](#)

Network Interface Specifications

Wi-Fi

Standards	IEEE802.11a/b/g/n/ac; IEEE802.11n available only on the 20 MHz channel
Frequency ranges	IEEE802.11b/g/n: 2.4 GHz IEEE802.11a/n/ac: 5 GHz (U.S. and Canada)

Wi-Fi channels	<p>2.4 GHz: 1/2/3/4/5/6/7/8/9/10/11</p> <p>5 GHz (U.S. and Canada)*: W52 (36/40/44/48) W53 (52/56/60/64) W56 (100/104/108/112/116/132/136/140) W58 (149/153/157/161/165)</p>
Wi-Fi Direct channels	<p>2.4 GHz: 1/2/3/4/5/6/7/8/9/10/11</p> <p>5 GHz (U.S. and Canada)*: W52 (36/40/44/48) W58 (149/153/157/161/165)</p>
Maximum radio-frequency power transmitted	20 dBm (EIRP)
Connection modes	<p>Infrastructure mode</p> <p>Wi-Fi Direct (Simple AP); not supported for IEEE802.11b</p> <p>Note: Infrastructure and Wi-Fi Direct modes can be used simultaneously.</p>
Wireless security protocols	<p>WEP (64/128 bit)</p> <p>WPA2-PSK (AES); complies with WPA2 standards with support for WPA/WPA2 Personal</p> <p>WPA3-SAE (AES)</p> <p>Note: Wi-Fi Direct supports only WPA2-PSK (AES).</p>

* The availability of outdoor use over these channels varies by location, as described in the table below.

Limitations for Using 5GHz Frequencies Outdoors (U.S. and Canada)

Frequency range	W52	W53	W56	W58
Frequency	5150-5250 MHz	5250-5350 MHz	5470-5725 MHz	5725-5850 MHz
Channel	36/40/44/48	52/56/60/64	100/104/108/112/116/ 132/136/140	149/153/157/161/ 165
U.S.	Outdoor use allowed	Outdoor use allowed	Outdoor use allowed	Outdoor use allowed
Canada	Outdoor use prohibited	Outdoor use allowed	Outdoor use allowed	Outdoor use allowed

Ethernet

Standard

IEEE802.3i (10BASE-T) (Use a category 5e or higher STP (shielded twisted pair) cable to prevent risk of radio interference.)

IEEE802.3u (100BASE-TX)

IEEE802.3az (Energy Efficient Ethernet)*

Communication mode

Auto, 10Mbps Full duplex, 10Mbps Half duplex, 100Mbps Full duplex, 100Mbps Half duplex

* The connected device should be IEEE802.3az compliant.

Security

Security protocol

SSL/TLS: HTTPS Server/Client, IPPS, SMTPS (STARTTLS, SSL/TLS), SNMPv3

Parent topic: [Technical Specifications](#)

Safety and Approvals Specifications

United States

Safety: UL60950-1

EMC: FCC part 15 Subpart B class B

Canada

Safety: CAN/CSA C22.2 No. 60950-1

EMC: CAN ICES-3 (B)/NMB-3 (B)

This equipment contains the following wireless module:

- Manufacturer: Seiko Epson Corporation.
- Type: J26H005

This product conforms to Part 15 of FCC Rules and RSS-210 of the IC Rules. Epson cannot accept responsibility for any failure to satisfy the protection requirements resulting from a non-recommended modification of the product. Operation is subject to the following two conditions: (1) this device may not cause harmful interference, and (2) this device must accept any interference received, including interference that may cause undesired operation of the device.

To prevent radio interference to the licensed service, this device is intended to be operated indoors and away from windows to provide maximum shielding. Equipment (or its transmit antenna) that is installed outdoors is subject to licensing.

This equipment complies with FCC/IC radiation exposure limits set forth for an uncontrolled environment and meets the FCC radio frequency (RF) Exposure Guidelines in Supplement C to OET65 and RSS-102 of the IC radio frequency (RF) Exposure rules. This equipment should be installed and operated so that the radiator is kept at least 7.9 inches (20 cm) or more away from a person's body (excluding extremities: hands, wrists, feet and ankles).

Parent topic: [Technical Specifications](#)

Notices

Check these sections for important notices about your product.

Note: Epson offers a recycling program for end of life Epson products. Please go to [this site](#) (U.S) or [this site](#) (Canada) for information on how to return your Epson products for proper disposal.

[Important Safety Instructions](#)

[Important Privacy Notice \(Printer Serial Number\)](#)

[FCC Compliance Statement](#)

[Binding Arbitration and Class Waiver](#)

[Trademarks](#)

[Copyright Notice](#)

Important Safety Instructions

Before using your Epson product, read and follow these safety instructions.

[General Product Safety Instructions](#)

[Ink Cartridge Safety Instructions](#)

[LCD Screen Safety Instructions](#)

[Wireless Connection Safety Instructions](#)

[Telephone Equipment Safety Instructions](#)

Parent topic: [Notices](#)

General Product Safety Instructions

- Be sure to follow all warnings and instructions marked on the product.
- Use only the type of power source indicated on the product's label.
- Use only the power cord that comes with the product. Use of another cord may cause fires or shock. Do not use the cord with any other equipment.
- Make sure the AC power cord meets the relevant local safety standard.
- Place the product near a wall outlet where the plug can be easily unplugged.
- Avoid plugging the product into an outlet on the same circuit as a photo copier or air control system that regularly switches on and off, or on an outlet controlled by a wall switch or timer.

- Do not let the power cord become damaged or frayed. Place it to avoid abrasions, cuts, fraying, crimping, and kinking. Do not place objects on top of it and do not allow it to be stepped on or run over. Be careful to keep the cord straight at each end.
- If you use an extension cord with the product, make sure the total ampere rating of the devices plugged into the extension cord does not exceed the cord's ampere rating. Also, make sure the total ampere rating of all devices plugged into the wall outlet does not exceed the wall outlet's ampere rating.
- Always turn off the product using the power button, and wait until the power light stops flashing before unplugging the product or cutting off power to the electrical outlet.
- If you will not be using the product for a long period, unplug the power cord from the electrical outlet.
- Place the product on a flat, stable surface that extends beyond its base in all directions. It will not operate properly if it is tilted or at an angle.
- Allow space behind the product for the cables, and space above the product so that you can fully raise the document cover.
- Leave enough space in front of the product for the paper to be fully ejected.
- Avoid locations that are subject to rapid changes in heat or humidity, shocks or vibrations, or dust.
- Do not place or store the product outdoors.
- Do not place the product near excessive heat sources or in direct sunlight.
- Leave enough room around the product for sufficient ventilation. Do not block or cover openings in the case or insert objects through the slots.
- Keep the product away from potential sources of electromagnetic interference, such as loudspeakers or the base units of cordless telephones.
- Keep your product at least 8.7 inches (22 cm) away from cardiac pacemakers to prevent your product's radio waves from affecting the operation of the pacemaker.
- When connecting the product to a computer or other device with a cable, ensure the correct orientation of the connectors. Each connector has only one correct orientation. Inserting a connector in the wrong orientation may damage both devices connected by the cable.
- Do not sit or lean on the product. Do not place heavy objects on the product.
- Do not touch the flat white cable inside the product.
- Do not move the print head by hand; this may damage the product.
- Do not put your hand inside the product while it is printing.
- Do not spill liquid on the product or use the product with wet hands.

- Do not use aerosol products that contain flammable gases inside or around the product. Doing so may cause fire.
- Do not press too hard on the scanner glass when placing originals.
- Do not open the scanner section while the product is copying, printing, scanning, or performing any other functions.
- Be careful not to trap your fingers when closing the scanner unit.
- Except as specifically explained in your documentation, do not attempt to service or disassemble the product yourself.
- Unplug the product and refer servicing to qualified service personnel under the following conditions: if the power cord or plug is damaged; if liquid has entered the product; if the product has been dropped or the case damaged; if the product does not operate normally or exhibits a distinct change in performance. Adjust only those controls that are covered by the operating instructions.
- Leave the ink cartridges installed. Removing the cartridges can dehydrate the print head and may prevent the product from printing.
- Before transporting the product, make sure that the print head is in the home (far right) position.
- When storing or transporting the product, do not tilt it, stand it on its side, or turn it upside down; otherwise, ink may leak.

Parent topic: [Important Safety Instructions](#)

Ink Cartridge Safety Instructions

- Keep ink cartridges out of the reach of children and do not drink the ink.
- Be careful when you handle used ink cartridges; there may be ink remaining around the ink supply port. If ink gets on your skin, wash it off with soap and water. If it gets in your eyes, flush them immediately with water. If you experience discomfort or vision problems after flushing your eyes, see a doctor immediately. If ink gets in your mouth, see a doctor immediately.
- Do not put your hand inside the product or touch any cartridges during printing.
- Install a new ink cartridge immediately after removing an expended one. Leaving cartridges uninstalled can dry out the print head and may prevent the product from printing.
- Do not remove or tear the label on the cartridge; this can cause leakage.
- Do not drop or knock ink cartridges against hard objects; this can cause leakage.
- Do not remove the transparent seal from the bottom of the cartridge. This may cause the cartridge to become unusable.
- Do not break the hooks on the side of the cartridge when removing it from the packaging.

- Do not touch the green IC chip on the side of the cartridge. This may prevent normal operation.
- Do not shake cartridges after opening their packages; this can cause them to leak.
- Do not shake cartridges too vigorously; this can cause them to leak.
- If you remove an ink cartridge for later use, protect the ink supply area from dirt and dust and store it in the same environment as the product. Note that there is a valve in the ink supply port, making covers or plugs unnecessary, but care is needed to prevent the ink from staining items that the cartridge touches. Do not touch the ink cartridge ink supply port or surrounding area.
- Use an ink cartridge before the date printed on its package or within six months of opening the package, whichever is earlier.
- Do not dismantle an ink cartridge. This could damage the print head.
- Store ink cartridges in a cool, dark place; do not store the ink cartridges in high or freezing temperatures.
- After bringing an ink cartridge inside from a cold storage site, allow it to warm up at room temperature for at least three hours before using it.
- Store ink cartridges with their bottoms down. Do not store cartridges upside down.

Parent topic: [Important Safety Instructions](#)

LCD Screen Safety Instructions

- Use only a dry, soft cloth to clean the LCD screen. Do not use liquid or chemical cleansers.
- If the LCD screen is damaged, contact Epson. If the liquid crystal solution gets on your hands, wash them thoroughly with soap and water. If the liquid crystal solution gets into your eyes, flush them immediately with water. If discomfort or vision problems remain after a thorough flushing, see a doctor immediately.
- Do not press too hard on the LCD screen or subject it to heavy impacts.
- Do not use a pointy or sharp object, such as a pen or your fingernail, to operate the LCD screen.
- If the LCD screen chips or cracks, do not touch or attempt to remove the broken pieces; contact Epson for support.
- Do not subject your product to sudden changes in temperature or humidity; this may cause condensation to develop inside the LCD screen and degrade its performance.
- The LCD screen may contain a few small bright or dark spots, and may display uneven brightness. These are normal and do not indicate that the screen is damaged in any way.

Parent topic: [Important Safety Instructions](#)

Wireless Connection Safety Instructions

Radio waves from this product may adversely affect the operation of medical equipment or automatically controlled devices, such as pacemakers, automatic doors or fire alarms. When using this product near such devices or inside a medical facility, follow the directions from authorized staff members at the facility, and follow all posted warnings and directions on the device to avoid causing an accident.

Parent topic: [Important Safety Instructions](#)

Telephone Equipment Safety Instructions

When using telephone equipment, you should always follow basic safety precautions to reduce the risk of fire, electric shock, and personal injury, including the following:

- Do not use the Epson product near water.
- Avoid using a telephone during an electrical storm. There may be a remote risk of electric shock from lightning.
- Do not use a telephone to report a gas leak in the vicinity of the leak.

Caution: To reduce the risk of fire, use only a No. 26 AWG or larger telecommunication line cord.

Parent topic: [Important Safety Instructions](#)

Important Privacy Notice (Printer Serial Number)

As part of setup, your product's serial number will be sent to a secure Epson server so that you can be eligible to participate in programs we may offer from time to time, including the Epson ink replenishment program. You will have a separate opportunity to consent to participating in such programs.

If you have any questions concerning this process, you can contact us by using the [Privacy Feedback Form](#), or you can write to:

Epson America, Inc.
Attn: Privacy Coordinator
3131 Katella Avenue
Los Alamitos, CA 90720

Parent topic: [Notices](#)

FCC Compliance Statement

For United States Users

This equipment complies with Part 68 of the FCC rules and the requirements adopted by the Administrative Council for Terminal Attachments ("ACTA"). On the surface of this equipment is a label that contains, among other information, a product identifier in the format US:AAAEQ##TXXXX. If requested, this number must be provided to the telephone company.

Applicable certification jack Universal Service Order Codes ("USOC") for the equipment: RJ11C.

A plug and jack used to connect this equipment to the premises wiring and telephone network must comply with the applicable FCC Part 68 rules and requirements adopted by the ACTA. A compliant telephone cord and modular plug is provided with this product. It is designed to be connected to a compatible modular jack that is also compliant. See installation instructions for details.

The REN is used to determine the number of devices that may be connected to a telephone line. Excessive RENs on a telephone line may result in the devices not ringing in response to an incoming call. In most but not all areas, the sum of RENs should not exceed five (5.0). To be certain of the number of devices that may be connected to a line, as determined by the total RENs, contact the local telephone company. For products approved after July 23, 2001, the REN for this product is part of the product identifier that has the format US:AAAEQ##TXXXX. The digits represented by ## are the REN without a decimal point (e.g., 03 is a REN of 0.3). For earlier products, the REN is separately shown on the label.

If this equipment causes harm to the telephone network, the telephone company will notify you in advance that temporary discontinuance of service may be required. But if advance notice isn't practical, the telephone company will notify the customer as soon as possible. Also, you will be advised of your right to file a complaint with the FCC if you believe it is necessary.

The telephone company may make changes in its facilities, equipment, operations, or procedures that could affect the operation of the equipment. If this happens the telephone company will provide advance notice in order for you to make necessary modifications to maintain uninterrupted service.

If you have problems with this product and require technical or customer support, please visit www.epson.com for more information.

This product is not intended to be repaired by the customer. If you experience trouble connecting this equipment to a telephone line, please contact:

Name: Epson America, Inc.

Address: 3131 Katella Ave., Los Alamitos, CA 90720 U.S.A.

Telephone: (562) 981-3840

If the equipment is causing harm to the telephone network, the telephone company may request that you disconnect the equipment until the problem is resolved.

This equipment may not be used on coin service provided by the telephone company. Connection to party line service is subject to state tariffs. Contact the state public utility commission, public service commission or corporation commission for information.

If your home has specially wired alarm equipment connected to the telephone line, ensure the installation of this equipment does not disable your alarm equipment. If you have questions about what will disable alarm equipment, consult your telephone company or a qualified installer.

The Telephone Consumer Protection Act of 1991 makes it unlawful for any person to use a computer or other electronic device, including fax machines, to send any message unless such message clearly contains in a margin at the top or bottom of each transmitted page or on the first page of the transmission, the date and time it is sent and an identification of the business or other entity, or other individual sending the message and the telephone number of the sending machine or such business, other entity, or individual. (The telephone number provided may not be a 900 number or any other number for which charges exceed local or long-distance transmission charges.)

In order to program this information into your fax machine, click the link below for instructions on entering fax header information.

According to the FCC's electrical safety advisory, we recommend that you may install an AC surge arrester in the AC outlet to which this equipment is connected. Telephone companies report that electrical surges, typically lightning transients, are very destructive to customer terminal equipment connected to AC power sources and that this is a major nationwide problem.

This equipment has been tested and found to comply with the limits for a Class B digital device, pursuant to Part 15 of the FCC Rules. These limits are designed to provide reasonable protection against harmful interference in a residential installation. This equipment generates, uses, and can radiate radio frequency energy and, if not installed and used in accordance with the instructions, may cause harmful interference to radio or television reception. However, there is no guarantee that interference will not occur in a particular installation. If this equipment does cause interference to radio and television reception, which can be determined by turning the equipment off and on, the user is encouraged to try to correct the interference by one or more of the following measures:

- Reorient or relocate the receiving antenna.
- Increase the separation between the equipment and receiver.
- Connect the equipment into an outlet on a circuit different from that to which the receiver is connected.
- Consult the dealer or an experienced radio/TV technician for help.

WARNING

The connection of a non-shielded equipment interface cable to this equipment will invalidate the FCC Certification or Declaration of this device and may cause interference levels which exceed the limits established by the FCC for this equipment. It is the responsibility of the user to obtain and use a shielded

equipment interface cable with this device. If this equipment has more than one interface connector, do not leave cables connected to unused interfaces. Changes or modifications not expressly approved by the manufacturer could void the user's authority to operate the equipment.

For Canadian Users

1. This product meets the applicable Innovation, Science and Economic Development Canada technical specifications.
2. The Ringer Equivalence Number indicates the maximum number of devices allowed to be connected to a telephone interface. The termination of an interface may consist of any combination of devices subject only to the requirement that the sum of the RENs of all the devices does not exceed five.

CAN ICES-3(B)/NMB-3(B)

Le présent produit est conforme aux spécifications techniques applicables d'Innovation, Sciences et Développement économique Canada.

L'indice d'équivalence de la sonnerie (IES) sert à indiquer le nombre maximal de dispositifs qui peuvent être raccordés à une interface téléphonique. La terminaison d'une interface peut consister en une combinaison quelconque de dispositifs, à la seule condition que la somme des IES de tous les dispositifs n'excède pas cinq.

CAN ICES-3(B)/NMB-3(B)

Parent topic: [Notices](#)

Related tasks

[Using the Fax Setup Wizard](#)

Binding Arbitration and Class Waiver

1. DISPUTES, BINDING INDIVIDUAL ARBITRATION, AND WAIVER OF CLASS ACTIONS AND CLASS ARBITRATIONS

1.1 Disputes. The terms of this Section 1 shall apply to all Disputes between you and Epson. The term "Dispute" is meant to have the broadest meaning permissible under law and includes any dispute, claim, controversy or action between you and Epson arising out of or relating to this Agreement, Epson branded products (hardware and including any related software), or other transaction involving you and Epson, whether in contract, warranty, misrepresentation, fraud, tort, intentional tort, statute, regulation, ordinance, or any other legal or equitable basis. "DISPUTE" DOES NOT INCLUDE IP CLAIMS, or more specifically, a claim or cause of action for (a) trademark infringement or dilution, (b) patent infringement, (c) copyright infringement or misuse, or (d) trade secret misappropriation (an "IP Claim"). You and Epson also agree, notwithstanding Section 1.6, that a court, not an arbitrator, may decide if a claim or cause of action is for an IP Claim.

1.2 Binding Arbitration. You and Epson agree that all Disputes shall be resolved by binding arbitration according to this Agreement. **ARBITRATION MEANS THAT YOU WAIVE YOUR RIGHT TO A JUDGE OR JURY IN A COURT PROCEEDING AND YOUR GROUNDS FOR APPEAL ARE LIMITED.**

Pursuant to this Agreement, binding arbitration shall be administered by JAMS, a nationally recognized arbitration authority, pursuant to its code of procedures then in effect for consumer related disputes, but excluding any rules that permit joinder or class actions in arbitration (for more detail on procedure, see Section 1.6 below). You and Epson understand and agree that (a) the Federal Arbitration Act (9 U.S.C. §1, et seq.) governs the interpretation and enforcement of this Section 1, (b) this Agreement memorializes a transaction in interstate commerce, and (c) this Section 1 shall survive termination of this Agreement.

1.3 Pre-Arbitration Steps and Notice. Before submitting a claim for arbitration, you and Epson agree to try, for sixty (60) days, to resolve any Dispute informally. If Epson and you do not reach an agreement to resolve the Dispute within the sixty (60) days, you or Epson may commence an arbitration. Notice to Epson must be addressed to: Epson America, Inc., ATTN: Legal Department, 3131 Katella Ave., Los Alamitos, CA 90720 (the "Epson Address"). The Dispute Notice to you will be sent to the most recent address Epson has in its records for you. For this reason, it is important to notify us if your address changes by emailing us at EAlegal@ea.epson.com or writing us at the Epson Address above. Notice of the Dispute shall include the sender's name, address and contact information, the facts giving rise to the Dispute, and the relief requested (the "Dispute Notice"). Following receipt of the Dispute Notice, Epson and you agree to act in good faith to resolve the Dispute before commencing arbitration.

1.4 Small Claims Court. Notwithstanding the foregoing, you may bring an individual action in the small claims court of your state or municipality if the action is within that court's jurisdiction and is pending only in that court.

1.5 WAIVER OF CLASS ACTIONS AND CLASS ARBITRATIONS. YOU AND EPSON AGREE THAT EACH PARTY MAY BRING DISPUTES AGAINST THE OTHER PARTY ONLY IN AN INDIVIDUAL CAPACITY, AND NOT AS A PLAINTIFF OR CLASS MEMBER IN ANY CLASS OR REPRESENTATIVE PROCEEDING, INCLUDING WITHOUT LIMITATION FEDERAL OR STATE CLASS ACTIONS, OR CLASS ARBITRATIONS. CLASS ACTION LAWSUITS, CLASS-WIDE ARBITRATIONS, PRIVATE ATTORNEY-GENERAL ACTIONS, AND ANY OTHER PROCEEDING WHERE SOMEONE ACTS IN A REPRESENTATIVE CAPACITY ARE NOT ALLOWED. ACCORDINGLY, UNDER THE ARBITRATION PROCEDURES OUTLINED IN THIS SECTION, AN ARBITRATOR SHALL NOT COMBINE OR CONSOLIDATE MORE THAN ONE PARTY'S CLAIMS WITHOUT THE WRITTEN CONSENT OF ALL AFFECTED PARTIES TO AN ARBITRATION PROCEEDING.

1.6 Arbitration Procedure. If you or Epson commences arbitration, the arbitration shall be governed by the rules of JAMS that are in effect when the arbitration is filed, excluding any rules that permit arbitration on a class or representative basis (the "JAMS Rules"), available at <http://www.jamsadr.com> or by calling 1-800-352-5267, and under the rules set forth in this Agreement. All Disputes shall be resolved by a single neutral arbitrator, and both parties shall have a reasonable opportunity to participate in the

selection of the arbitrator. The arbitrator is bound by the terms of this Agreement. The arbitrator, and not any federal, state or local court or agency, shall have exclusive authority to resolve all disputes arising out of or relating to the interpretation, applicability, enforceability or formation of this Agreement, including any claim that all or any part of this Agreement is void or voidable. Notwithstanding this broad delegation of authority to the arbitrator, a court may determine the limited question of whether a claim or cause of action is for an IP Claim, which is excluded from the definition of "Disputes" in Section 1.1 above. The arbitrator shall be empowered to grant whatever relief would be available in a court under law or in equity. The arbitrator may award you the same damages as a court could, and may award declaratory or injunctive relief only in favor of the individual party seeking relief and only to the extent necessary to provide relief warranted by that party's individual claim. In some instances, the costs of arbitration can exceed the costs of litigation and the right to discovery may be more limited in arbitration than in court. The arbitrator's award is binding and may be entered as a judgment in any court of competent jurisdiction.

You may choose to engage in arbitration hearings by telephone. Arbitration hearings not conducted by telephone shall take place in a location reasonably accessible from your primary residence, or in Orange County, California, at your option.

a) Initiation of Arbitration Proceeding. If either you or Epson decides to arbitrate a Dispute, both parties agree to the following procedure:

(i) Write a Demand for Arbitration. The demand must include a description of the Dispute and the amount of damages sought to be recovered. You can find a copy of a Demand for Arbitration at <http://www.jamsadr.com> ("Demand for Arbitration").

(ii) Send three copies of the Demand for Arbitration, plus the appropriate filing fee, to: JAMS, 500 North State College Blvd., Suite 600 Orange, CA 92868, U.S.A.

(iii) Send one copy of the Demand for Arbitration to the other party (same address as the Dispute Notice), or as otherwise agreed by the parties.

b) Hearing Format. During the arbitration, the amount of any settlement offer made shall not be disclosed to the arbitrator until after the arbitrator determines the amount, if any, to which you or Epson is entitled. The discovery or exchange of non-privileged information relevant to the Dispute may be allowed during the arbitration.

c) Arbitration Fees. Epson shall pay, or (if applicable) reimburse you for, all JAMS filings and arbitrator fees for any arbitration commenced (by you or Epson) pursuant to provisions of this Agreement.

d) Award in Your Favor. For Disputes in which you or Epson seeks \$75,000 or less in damages exclusive of attorney's fees and costs, if the arbitrator's decision results in an award to you in an amount greater than Epson's last written offer, if any, to settle the Dispute, Epson will: (i) pay you \$1,000 or the amount of the award, whichever is greater; (ii) pay you twice the amount of your reasonable attorney's fees, if any; and (iii) reimburse you for any expenses (including expert witness fees and costs) that your attorney reasonably accrues for investigating, preparing, and pursuing the Dispute in arbitration. Except as

agreed upon by you and Epson in writing, the arbitrator shall determine the amount of fees, costs, and expenses to be paid by Epson pursuant to this Section 1.6d).

e) Attorney's Fees. Epson will not seek its attorney's fees and expenses for any arbitration commenced involving a Dispute under this Agreement. Your right to attorney's fees and expenses under Section 1.6d) above does not limit your rights to attorney's fees and expenses under applicable law; notwithstanding the foregoing, the arbitrator may not award duplicative awards of attorney's fees and expenses.

1.7 Opt-out. You may elect to opt-out (exclude yourself) from the final, binding, individual arbitration procedure and waiver of class and representative proceedings specified in this Agreement by sending a written letter to the Epson Address within thirty (30) days of your assent to this Agreement (including without limitation the purchase, download, installation of the Software or other applicable use of Epson Hardware, products and services) that specifies (i) your name, (ii) your mailing address, and (iii) your request to be excluded from the final, binding individual arbitration procedure and waiver of class and representative proceedings specified in this Section 1. In the event that you opt-out consistent with the procedure set forth above, all other terms shall continue to apply, including the requirement to provide notice prior to litigation.

1.8 Amendments to Section 1. Notwithstanding any provision in this Agreement to the contrary, you and Epson agree that if Epson makes any future amendments to the dispute resolution procedure and class action waiver provisions (other than a change to Epson's address) in this Agreement, Epson will obtain your affirmative assent to the applicable amendment. If you do not affirmatively assent to the applicable amendment, you are agreeing that you will arbitrate any Dispute between the parties in accordance with the language of this Section 1 (or resolve disputes as provided for in Section 1.7, if you timely elected to opt-out when you first assented to this Agreement).

1.9 Severability. If any provision in this Section 1 is found to be unenforceable, that provision shall be severed with the remainder of this Agreement remaining in full force and effect. **The foregoing shall not apply to the prohibition against class or representative actions as provided in Section 1.5. This means that if Section 1.5 is found to be unenforceable, the entire Section 1 (but only Section 1) shall be null and void.**

Parent topic: [Notices](#)

Trademarks

EPSON® is a registered trademark, EPSON Exceed Your Vision is a registered logomark, and Epson Connect™ is a trademark of Seiko Epson Corporation.

Epson StoreSM is a service mark of Epson America, Inc.

Epson iPrint™ and Remote Print™ are trademarks of Seiko Epson Corporation.

Windows is a registered trademark of Microsoft Corporation in the United States and/or other countries.

Mac, macOS, OS X, Bonjour, ColorSync, AirPrint, iPad, iPhone, iPod touch, App Store, and iTunes are trademarks of Apple Inc., registered in the U.S. and other countries.

Use of the Works with Apple badge means that an accessory has been designed to work specifically with the technology identified in the badge and has been certified by the developer to meet Apple performance standards.

Google[®] is a registered trademark and Android[™], Chromebook[™], Gmail[™], Google Chrome[™], Google Drive[™], Google Photos[™], and Google Play[™] are trademarks of Google LLC.

Wi-Fi Direct[®] is a registered trademark of Wi-Fi Alliance[®].

General Notice: Other product names used herein are for identification purposes only and may be trademarks of their respective owners. Epson disclaims any and all rights in those marks.



Parent topic: [Notices](#)

Copyright Notice

All rights reserved. No part of this publication may be reproduced, stored in a retrieval system, or transmitted in any form or by any means, electronic, mechanical, photocopying, recording, or otherwise, without the prior written permission of Seiko Epson Corporation. The information contained herein is designed only for use with this Epson product. Epson is not responsible for any use of this information as applied to other products.

Neither Seiko Epson Corporation nor its affiliates shall be liable to the purchaser of this product or third parties for damages, losses, costs, or expenses incurred by purchaser or third parties as a result of: accident, misuse, or abuse of this product or unauthorized modifications, repairs, or alterations to this product, or (excluding the U.S.) failure to strictly comply with Seiko Epson Corporation's operating and maintenance instructions.

Seiko Epson Corporation shall not be liable for any damages or problems arising from the use of any options or any consumable products other than those designated as Original Epson Products or Epson Approved Products by Seiko Epson Corporation.

Seiko Epson Corporation shall not be held liable for any damage resulting from electromagnetic interference that occurs from the use of any interface cables other than those designated as Epson approved Products by Seiko Epson Corporation.

This information is subject to change without notice.

[libTIFF Software Acknowledgment](#)

[A Note Concerning Responsible Use of Copyrighted Materials](#)

[Default Delay Times for Power Management for Epson Products](#)

[Copyright Attribution](#)

Parent topic: [Notices](#)

libTIFF Software Acknowledgment

Copyright © 1988-1997 Sam Leffler

Copyright © 1991-1997 Silicon Graphics, Inc.

Permission to use, copy, modify, distribute, and sell this software and its documentation for any purpose is hereby granted without fee, provided that (i) the above copyright notices and this permission notice appear in all copies of the software and related documentation, and (ii) the names of Sam Leffler and Silicon Graphics may not be used in any advertising or publicity relating to the software without the specific, prior written permission of Sam Leffler and Silicon Graphics.

THE SOFTWARE IS PROVIDED "AS-IS" AND WITHOUT WARRANTY OF ANY KIND, EXPRESS, IMPLIED OR OTHERWISE, INCLUDING WITHOUT LIMITATION, ANY WARRANTY OF MERCHANTABILITY OR FITNESS FOR A PARTICULAR PURPOSE.

IN NO EVENT SHALL SAM LEFFLER OR SILICON GRAPHICS BE LIABLE FOR ANY SPECIAL, INCIDENTAL, INDIRECT OR CONSEQUENTIAL DAMAGES OF ANY KIND, OR ANY DAMAGES WHATSOEVER RESULTING FROM LOSS OF USE, DATA OR PROFITS, WHETHER OR NOT ADVISED OF THE POSSIBILITY OF DAMAGE, AND ON ANY THEORY OF LIABILITY, ARISING OUT OF OR IN CONNECTION WITH THE USE OR PERFORMANCE OF THIS SOFTWARE.

Parent topic: [Copyright Notice](#)

A Note Concerning Responsible Use of Copyrighted Materials

Epson encourages each user to be responsible and respectful of the copyright laws when using any Epson product. While some countries' laws permit limited copying or reuse of copyrighted material in certain circumstances, those circumstances may not be as broad as some people assume. Contact your legal advisor for any questions regarding copyright law.

Parent topic: [Copyright Notice](#)

Default Delay Times for Power Management for Epson Products

This product will enter sleep mode after a period of nonuse. This is to ensure that the product meets Energy Star standards of energy efficiency. More energy savings can be achieved by setting the time to sleep to a shorter interval.

Parent topic: [Copyright Notice](#)

Copyright Attribution

© 2022 Epson America, Inc.

1/22

CPD-61485

Parent topic: [Copyright Notice](#)